

Control System Toolbox™ 8

User's Guide

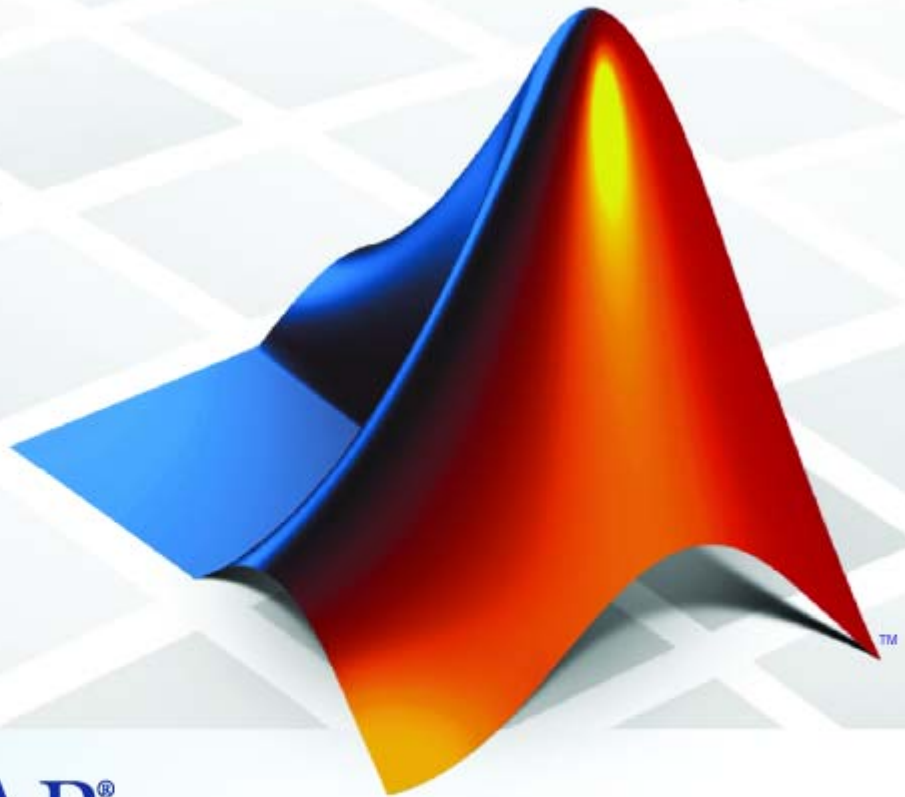

MATLAB®

How to Contact The MathWorks



www.mathworks.com Web
comp.soft-sys.matlab Newsgroup
www.mathworks.com/contact_TS.html Technical Support



suggest@mathworks.com Product enhancement suggestions
bugs@mathworks.com Bug reports
doc@mathworks.com Documentation error reports
service@mathworks.com Order status, license renewals, passcodes
info@mathworks.com Sales, pricing, and general information



508-647-7000 (Phone)



508-647-7001 (Fax)



The MathWorks, Inc.
3 Apple Hill Drive
Natick, MA 01760-2098

For contact information about worldwide offices, see the MathWorks Web site.

Control System Toolbox™ User's Guide

© COPYRIGHT 2001–2008 by The MathWorks, Inc.

The software described in this document is furnished under a license agreement. The software may be used or copied only under the terms of the license agreement. No part of this manual may be photocopied or reproduced in any form without prior written consent from The MathWorks, Inc.

FEDERAL ACQUISITION: This provision applies to all acquisitions of the Program and Documentation by, for, or through the federal government of the United States. By accepting delivery of the Program or Documentation, the government hereby agrees that this software or documentation qualifies as commercial computer software or commercial computer software documentation as such terms are used or defined in FAR 12.212, DFARS Part 227.72, and DFARS 252.227-7014. Accordingly, the terms and conditions of this Agreement and only those rights specified in this Agreement, shall pertain to and govern the use, modification, reproduction, release, performance, display, and disclosure of the Program and Documentation by the federal government (or other entity acquiring for or through the federal government) and shall supersede any conflicting contractual terms or conditions. If this License fails to meet the government's needs or is inconsistent in any respect with federal procurement law, the government agrees to return the Program and Documentation, unused, to The MathWorks, Inc.

Trademarks

MATLAB and Simulink are registered trademarks of The MathWorks, Inc. See www.mathworks.com/trademarks for a list of additional trademarks. Other product or brand names may be trademarks or registered trademarks of their respective holders.

Patents

The MathWorks products are protected by one or more U.S. patents. Please see www.mathworks.com/patents for more information.

Revision History

June 2001	Online only	New for Version 5.1 (Release 12.1)
July 2002	Online only	Revised for Version 5.2 (Release 13)
June 2004	Online only	Revised for Version 6.0 (Release 14)
March 2005	Online only	Revised for Version 6.2 (Release 14SP2)
September 2005	Online only	Revised for Version 6.2.1 (Release 14SP3)
March 2006	Online only	Revised for Version 7.0 (Release 2006a)
September 2006	Online only	Revised for Version 7.1 (Release 2006b)
March 2007	Online only	Revised for Version 8.0 (Release 2007a)
September 2007	Online only	Revised for Version 8.0.1 (Release 2007b)
March 2008	Online only	Revised for Version 8.1 (Release 2008a)
October 2008	Online only	Revised for Version 8.2 (Release 2008b)

LTI Models

Linear, Time-Invariant Models	1-2
Supported Model Types	1-2
LTI Model Formats	1-2
Examples of Creating LTI Models	1-3
Using LTI Models	1-6
LTI Objects	1-7
Precedence Rules	1-8
Viewing LTI Systems as Matrices	1-9
LTI Command Summary	1-10
Creating LTI Models	1-12
Transfer Function Models	1-12
Zero-Pole-Gain Models	1-16
State-Space Models	1-19
Descriptor State-Space Models	1-21
Frequency Response Data (FRD) Models	1-22
Creating Discrete-Time Models	1-24
Data Retrieval	1-28
LTI Properties	1-31
What are LTI Properties?	1-31
Generic LTI Properties	1-31
Model-Specific Properties	1-33
Setting LTI Properties	1-35
Accessing Property Values Using get	1-37
Direct Property Referencing Using Dot Notation	1-38
Additional Insight into LTI Properties	1-40
Model Conversion	1-46
Available Model Formats	1-46
Explicit Conversion	1-46
Automatic Conversion	1-47
Caution About Model Conversions	1-48

Time Delays	1-49
Supported Types of Delays	1-49
Available Properties for Modeling Delays	1-50
Input and Output Delays	1-50
Specifying I/O Delays in MIMO Models	1-53
Internal Delays	1-55
Analyzing Systems With Delays	1-59
Eliminating Time Delays: Padé Approximation	1-65
Sensitivity Analysis	1-68
Specifying Delays in Discrete-Time Models	1-71
Discretization	1-76
Functions That Support Internal Time Delays	1-78
Functions That Do Not Support Internal Time Delays ...	1-79
Inside Time Delay Models	1-79
Simulink Block for LTI Systems	1-82
References	1-84

Operations on LTI Models

2

Overview	2-2
Precedence and Property Inheritance	2-3
Extracting and Modifying Subsystems	2-5
What is a Subsystem?	2-5
Basic Subsystem Concepts	2-5
Referencing FRD Models Through Frequencies	2-8
Referencing Channels by Name	2-9
Resizing LTI Systems	2-10
Arithmetic Operations on LTI Models	2-12
Supported Arithmetic Operations	2-12
Addition and Subtraction	2-12
Multiplication	2-14
Inversion and Related Operations	2-15

Transposition	2-15
Pertransposition	2-16
Model Interconnection Functions	2-17
Supported Interconnection Functions	2-17
Concatenation of LTI Models	2-18
Feedback and Other Interconnection Functions	2-19
Continuous/Discrete Conversions of LTI Models	2-21
Supported Conversion Functions and Methods	2-21
Zero-Order Hold	2-21
First-Order Hold	2-23
Impulse Invariance	2-24
Tustin Approximation	2-27
Tustin with Frequency Prewarping	2-28
Matched Poles and Zeros	2-28
Discretization of Systems with Delays	2-28
Resampling of Discrete-Time Models	2-31
Available Commands for Resampling Discrete-Time Models	2-31
Example of Resampling a Discrete-Time Model	2-31
References	2-35

Model Analysis Tools

3

General Model Characteristics	3-2
Model Dynamics	3-4
State-Space Realizations	3-7

Concept of an LTI Array	4-2
What is an LTI Array?	4-2
When to Use an LTI Array	4-2
When to Collect a Set of Models in an LTI Array	4-3
Restrictions for LTI Models Collected in an Array	4-3
Where to Find Information on LTI Arrays	4-4
Visualizing LTI Arrays	4-4
Higher Dimensional Arrays of LTI Models	4-6
Dimensions, Size, and Shape of an LTI Array	4-8
I/O and Array Dimensions of LTI Arrays	4-8
Accessing the Dimensions of an LTI Array Using size and ndims	4-10
Using reshape to Rearrange an LTI Array	4-12
Building LTI Arrays	4-13
Ways to Build LTI Arrays	4-13
Building LTI Arrays Using for Loops	4-13
Building LTI Arrays Using the stack Function	4-16
Building LTI Arrays Using tf, zpk, ss, and frd	4-18
Generating Random LTI Arrays Using rss	4-21
Indexing into LTI Arrays	4-22
When to Index into LTI Arrays	4-22
Organization of Indices	4-22
Note on Indexing into LTI Arrays of FRD Models	4-23
Accessing Particular Models in an LTI Array	4-23
Extracting LTI Arrays of Subsystems	4-24
Reassigning Parts of an LTI Array	4-25
Deleting Parts of an LTI Array	4-26
Operations on LTI Arrays	4-27
Supported Operations on LTI Arrays	4-27
Example: Addition of Two LTI Arrays	4-28
Dimension Requirements	4-29
Special Cases for Operations on LTI Arrays	4-30
Other Operations on LTI Arrays	4-32

Customization Preliminaries

5

Terminology	5-2
The Property and Preferences Hierarchy	5-3

Setting Toolbox Preferences

6

Toolbox Preferences Editor	6-2
Overview of the Toolbox Preferences Editor	6-2
Opening the Toolbox Preferences Editor	6-2
Units Pane	6-4
Style Pane	6-5
Options Pane	6-6
SISO Tool Pane	6-7

Setting Tool Preferences

7

Introduction	7-2
LTI Viewer Preferences Editor	7-3
Opening the LTI Viewer Preference Editor	7-3
Units Pane	7-4
Style Pane	7-4
Options Pane	7-5
Parameters Pane	7-6

Graphical Tuning Window Preferences Editor	7-8
Opening the Graphical Tuning Window Preferences Editor	7-8
Units Pane	7-9
Style Pane	7-9
Options Pane	7-12
Line Colors Pane	7-13

Customizing Response Plot Properties

8

Introduction	8-2
 Customizing Response Plots Using the Response Plots Property Editor	8-3
Opening the Property Editor	8-3
Overview of Response Plots Property Editor	8-4
Labels Pane	8-6
Limits Pane	8-6
Units Pane	8-7
Style Pane	8-8
Options Pane	8-9
Editing Subplots Using the Property Editor	8-11
 Customizing Response Plots Using Plot Tools	8-12
Properties You Can Customize Using Plot Tools	8-12
Opening and Working with Plot Tools	8-13
Example of Changing Line Color Using Plot Tools	8-13
 Customizing Response Plots from the Command Line	8-16
Overview of Customizing Plots from the Command Line ..	8-16
Obtaining Plot Handles	8-19
Obtaining Plot Options Handles	8-20
Examples of Customizing Plots from the Command Line ..	8-23
Properties and Values Reference	8-27
Property Organization Reference	8-36
 Customizing Plots Inside the SISO Design Tool	8-37

Overview of Customizing SISO Design Tool Plots	8-37
Root Locus Property Editor	8-37
Open-Loop Bode Property Editor	8-41
Open-Loop Nichols Property Editor	8-43
Prefilter Bode Property Editor	8-45

Design Case Studies

9

Yaw Damper for a 747 Jet Transport	9-2
Overview of this Case Study	9-2
Creating the Jet Model	9-2
Computing Open-Loop Eigenvalues	9-4
Open-Loop Analysis	9-5
Root Locus Design	9-8
Washout Filter Design	9-13
Hard-Disk Read/Write Head Controller	9-19
Overview of this Case Study	9-19
Creating the Read/Write Head Model	9-19
Model Discretization	9-20
Adding a Compensator Gain	9-22
Adding a Lead Network	9-23
Design Analysis	9-26
LQG Regulation: Rolling Mill Example	9-30
Overview of this Case Study	9-30
Process and Disturbance Models	9-30
LQG Design for the x-Axis	9-34
LQG Design for the y-Axis	9-40
Cross-Coupling Between Axes	9-42
MIMO LQG Design	9-45
Kalman Filtering	9-49
Overview of this Case Study	9-49
Discrete Kalman Filter	9-50
Steady-State Design	9-51
Time-Varying Kalman Filter	9-57
Time-Varying Design	9-58

Reliable Computations

10

Scaling State-Space Models	10-2
Why Scaling Is Important	10-2
When to Scale Your Model	10-2
Manually Scaling Your Model	10-3
How To Get Accurate Results	10-8

SISO Design Tool

11

Overview of the SISO Design Tool	11-2
Opening the SISO Design Tool	11-3
Using the SISO Design Task Node	11-4
The SISO Design Task Node	11-4
SISO Design Task Node Menu Bar	11-5
Using the SISO Design Task in the Controls & Estimation Tools Manager	11-11
Architecture	11-11
Compensator Editor	11-17
Graphical Tuning	11-18
Analysis Plots	11-21
Automated Tuning	11-23
SISO Design Task Graphical Tuning Window	11-40
Using the Graphical Tuning Window Menu Bar	11-41

Overview of the Graphical Tuning Window Menu Bar	11-41
File	11-41
Edit	11-44
View	11-45
Analysis	11-46
Tools	11-47
Window	11-51
Help	11-51
Using the Graphical Tuning Window Toolbar	11-53
Using the Right-Click Menus in the Graphical Tuning	
Window	11-54
Overview of the Right-Click Menu	11-54
Add Pole/Zero	11-55
Delete Pole/Zero	11-58
Edit Compensator	11-58
Gain Target	11-58
Show	11-58
Design Requirements	11-59
Grid	11-71
Full View	11-71
Properties	11-72
Select Compensator	11-73
Status Pane	11-73
LTI Viewer for SISO Design Task Design	
Requirements	11-74
Overview of LTI Viewer Design Requirements	11-74
Available Design Requirements in the LTI Viewer	11-74
Example: Time Domain Requirement	11-75

LTI Viewer

12

Basic LTI Viewer Tasks	12-2
Using the Right-Click Menu in the LTI Viewer	12-4
Overview of the Right-Click Menu	12-4

Setting Characteristics of Response Plots	12-4
Adding Design Requirements	12-9
Importing, Exporting, and Deleting Models in the LTI	
Viewer	12-12
Importing Models	12-12
Exporting Models	12-13
Deleting Models	12-14
Selecting Response Types	
Methods for Selecting Response Types	12-16
Right Click Menu: Plot Type	12-16
Plot Configurations Window	12-16
Line Styles Editor	12-18
Analyzing MIMO Models	
Overview of Analyzing MIMO Models	12-20
Array Selector	12-21
I/O Grouping for MIMO Models	12-23
Selecting I/O Pairs	12-24
Customizing the LTI Viewer	
Overview of Customizing the LTI Viewer	12-25
LTI Viewer Preferences Editor	12-25

Index

LTI Models

- “Linear, Time-Invariant Models” on page 1-2
- “Creating LTI Models” on page 1-12
- “LTI Properties” on page 1-31
- “Model Conversion” on page 1-46
- “Time Delays” on page 1-49
- “Simulink Block for LTI Systems” on page 1-82
- “References” on page 1-84

Linear, Time-Invariant Models

In this section...

“Supported Model Types” on page 1-2
 “LTI Model Formats” on page 1-2
 “Examples of Creating LTI Models” on page 1-3
 “Using LTI Models” on page 1-6
 “LTI Objects” on page 1-7
 “Precedence Rules” on page 1-8
 “Viewing LTI Systems as Matrices” on page 1-9
 “LTI Command Summary” on page 1-10

Supported Model Types

You can use Control System Toolbox™ functions to manipulate and analyze linear time-invariant (LTI) models. You can use the functions for both continuous- and discrete-time systems. Systems can be single-input/single-output (SISO) or multiple-input/multiple-output (MIMO). In addition, you can store several LTI models in an array under a single variable name. See Chapter 4, “Arrays of LTI Models” for information on LTI arrays.

LTI Model Formats

You can specify LTI models as:

- Transfer functions (TF), for example,

$$P(s) = \frac{s + 2}{s^2 + s + 10}$$

- Zero-pole-gain models (ZPK), for example,

$$H(z) = \begin{bmatrix} \frac{2(z - 0.5)}{z(z + 0.1)} & \frac{(z^2 + z + 1)}{(z + 0.2)(z + 0.1)} \end{bmatrix}$$

- State-space models (SS), for example,

$$\frac{dx}{dt} = Ax + Bu$$

$$y = Cx + Du$$

where A , B , C , and D are matrices of appropriate dimensions, x is the state vector, and u and y are the input and output vectors.

- Frequency response data (FRD) models

FRD models consist of sampled measurements of a system's frequency response. For example, you can store experimentally collected frequency response data in an FRD.

Examples of Creating LTI Models

The following sections show simple examples of building LTI models. Note that all LTI models, including TF, ZPK, SS, and FRD are also MATLAB® objects. See “Defining Your Own Classes” in the MATLAB documentation if you are not familiar with objects and object syntax.

Example of Creating Transfer Function Models

You can create transfer function (TF) models by specifying numerator and denominator coefficients. For example,

```
num = [1 0];
den = [1 2 1];
sys = tf(num,den)
```

Transfer function:

```
      s
-----
s^2 + 2 s + 1
```

A useful trick is to create the Laplace variable, s . That way, you can specify polynomials using s as the polynomial variable.

```
s=tf('s');
sys= s/(s^2 + 2*s + 1)
```

Transfer function:

$$\frac{s}{s^2 + 2s + 1}$$

This is identical to the previous transfer function.

Example of Creating Zero-Pole-Gain Models

To create zero-pole-gain (ZPK) models, you must specify each of the three components in vector format. For example,

```
sys = zpk([0],[-1 -1],[1])
```

Zero/pole/gain:

$$\frac{s}{(s+1)^2}$$

produces the same transfer function built in the TF example, but the representation is now ZPK.

This example shows a more complicated ZPK model.

```
sys=zpk([1 0], [-1 -3 -.28],[.776])
```

Zero/pole/gain:

$$\frac{0.776 s (s-1)}{(s+1) (s+3) (s+0.28)}$$

Example of Creating State-Space Models

To create a state-space model, specify the A, B, C, and D matrices.

```
A= [-1 0; 0 -1];  
B= [1 ; 0];  
C= eye(2);  
D = zeros(2, 1);  
sys=ss(A, B, C, D)
```

```
a =
      x1  x2
x1  -1   0
x2   0  -1
```

```
b =
      u1
x1   1
x2   0
```

```
c =
      x1  x2
y1   1   0
y2   0   1
```

```
d =
      u1
y1   0
y2   0
```

Continuous-time model.

You can verify that this example has two poles at -1.

```
sys_poles = eig(sys)
```

```
sys_poles =
```

```
-1
-1
```

Example of Creating Frequency Response Data Models

You can create a frequency response data (FRD) model using measured data from your plant. The function `frd` requires at a minimum a column of

frequency responses and a column of associated frequencies. This example creates FRD data and then builds the FRD model.

```
freq = logspace(1,2); % Create 50 points of data.  
resp = .05*(freq).*exp(i*2*freq); % Create a response at each  
                                     %point.  
sys = frd(resp,freq);
```

Type

sys

to see all the data in the FRD model. To check that `sys` is an FRD model, you can use the `size` function.

```
size(sys)  
FRD model with 1 output(s) and 1 input(s), at 50 frequency  
point(s).
```

Since `sys` is an FRD object, as with any MATLAB object, you can access the data using dot notation.

```
freq= sys.Frequency;  
size(freq)
```

Using LTI Models

Once you have built LTI models, you can manipulate them using the arithmetic and model interconnection operations described in Chapter 2, “Operations on LTI Models” and analyze them using the model analysis functions, such as `bode` and `step`. FRD models can be manipulated and analyzed in much the same way you analyze the other model types, but analysis is restricted to frequency-domain methods.

Using a variety of design techniques, you can design compensators for systems specified with TF, ZPK, SS, and FRD models. These techniques include root locus analysis, pole placement, LQG optimal control, and frequency domain loop-shaping. For FRD models, you can either:

- Obtain an identified TF, SS, or ZPK model using system identification techniques.

- Use frequency-domain analysis techniques.

Other Uses of FRD Models

FRD models are unique model types available in the Control System Toolbox collection of LTI model types, in that they don't have a parametric representation. In addition to the standard operations you may perform on FRD models, you can also use them to:

- Perform frequency-domain analysis on systems with nonlinearities using describing functions.
- Validate identified models against experimental frequency response data.

LTI Objects

Depending on the type of model you use, the data for your model may consist of a simple numerator/denominator pair for SISO transfer functions, four matrices for state-space models, and multiple sets of zeros and poles for MIMO zero-pole-gain models or frequency and response vectors for FRD models. For convenience, the Control System Toolbox software provides customized data structures (*LTI objects*) for each type of model. These are called the TF, ZPK, SS, and FRD objects. These four LTI objects encapsulate the model data and enable you to manipulate LTI systems as single entities rather than collections of data vectors or matrices.

Creating an LTI Object: An Example

An LTI object of the type TF, ZPK, SS, or FRD is created whenever you invoke the corresponding constructor function, `tf`, `zpk`, `ss`, or `frd`. For example,

```
P = tf([1 2],[1 1 10])
```

creates a TF object, `P`, that stores the numerator and denominator coefficients of the transfer function

$$P(s) = \frac{s + 2}{s^2 + s + 10}$$

See “Creating LTI Models” on page 1-12 for methods for creating all of the LTI object types.

LTI Properties and Methods

The LTI object implementation relies on the MATLAB object-oriented programming capabilities. Objects are MATLAB structures with an additional flag indicating their class (TF, ZPK, SS, or FRD for LTI objects) and have predefined fields called *object properties*. For LTI objects, these properties include the model data, sample time, delay times, input or output names, and input or output groups (see “LTI Properties” on page 1-31 for details). The functions that operate on a particular object are called the object *methods*. These may include customized versions of simple operations such as addition or multiplication. For example,

```
P = tf([1 2],[1 1 10])
Q = 2 + P
```

performs transfer function addition.

$$Q(s) = 2 + P(s) = \frac{2s^2 + 3s + 22}{s^2 + s + 10}$$

The object-specific versions of such standard operations are called *overloaded* operations. For more details on objects, methods, and object-oriented programming, see “Defining Your Own Classes” in the MATLAB documentation. For details on operations on LTI objects, see Chapter 2, “Operations on LTI Models”

Precedence Rules

Operations like addition and commands like `feedback` operate on more than one LTI model at a time. If these LTI models are represented as LTI objects of different types (for example, the first operand is TF and the second operand is SS), it is not obvious what type (for example, TF or SS) the resulting model should be. Such type conflicts are resolved by *precedence rules*. Specifically, TF, ZPK, SS, and FRD objects are ranked according to the precedence hierarchy.

FRD > SS > ZPK > TF

Thus ZPK takes precedence over TF, SS takes precedence over both TF and ZPK, and FRD takes precedence over all three. In other words, any operation involving two or more LTI models produces:

- An FRD object if at least one operand is an FRD object
- An SS object if no operand is an FRD object and at least one operand is an SS object
- A ZPK object if no operand is an FRD or SS object and at least one is an ZPK object
- A TF object only if all operands are TF objects

Operations on systems of different types work as follows: the resulting type is determined by the precedence rules, and all operands are first converted to this type before performing the operation.

Viewing LTI Systems as Matrices

In the frequency domain, an LTI system is represented by the linear input/output map

$$y = Hu$$

This map is characterized by its transfer matrix H , a function of either the Laplace or Z-transform variable. The transfer matrix H maps inputs to outputs, so there are as many columns as inputs and as many rows as outputs.

If you think of LTI systems in terms of (transfer) matrices, certain basic operations on LTI systems are naturally expressed with a matrix-like syntax. For example, the parallel connection of two LTI systems `sys1` and `sys2` can be expressed as

$$\text{sys} = \text{sys1} + \text{sys2}$$

because parallel connection amounts to adding the transfer matrices. Similarly, subsystems of a given LTI model `sys` can be extracted using matrix-like subscripting. For instance,

$$\text{sys}(3, 1:2)$$

provides the I/O relation between the first two inputs (column indices) and the third output (row index), which is consistent with

$$\begin{bmatrix} y_1 \\ y_2 \\ y_3 \end{bmatrix} = \begin{bmatrix} H(1,1) & H(2,1) \\ H(2,1) & H(2,2) \\ H(3,1) & H(3,2) \end{bmatrix} \begin{bmatrix} u_1 \\ u_2 \end{bmatrix}$$

for $y = Hu$.

LTI Command Summary

The next two tables list the commands you can apply to LTI models.

Creating LTI Models

Command	Description
drss	Generate random discrete state-space model.
dss	Create descriptor state-space model.
filt	Create discrete filter with DSP convention.
frd	Create an FRD model.
frdata	Retrieve FRD model data.
get	Query LTI model properties.
set	Set LTI model properties.
rss	Generate random continuous state-space model.
ss	Create a state-space model.
ssdata, dssdata	Retrieve state-space data (respectively, descriptor state-space data).
tf	Create a transfer function.
tfdata	Retrieve transfer function data.
zpk	Create a zero-pole-gain model.
zpkdata	Retrieve zero-pole-gain data.

Converting LTI Models

Command	Description
c2d	Continuous- to discrete-time conversion.
d2c	Discrete- to continuous-time conversion.
d2d	Resampling of discrete-time models.
upsample	Upsampling of discrete-time models.
frd	Conversion to an FRD model.
pade	Padé approximation of input delays.
ss	Conversion to state space.
tf	Conversion to transfer function.
zpk	Conversion to zero-pole-gain.

Creating LTI Models

In this section...

“Transfer Function Models” on page 1-12

“Zero-Pole-Gain Models” on page 1-16

“State-Space Models” on page 1-19

“Descriptor State-Space Models” on page 1-21

“Frequency Response Data (FRD) Models” on page 1-22

“Creating Discrete-Time Models” on page 1-24

“Data Retrieval” on page 1-28

Transfer Function Models

This section explains how to specify continuous-time SISO and MIMO transfer function models. The specification of discrete-time transfer function models is a simple extension of the continuous-time case (see “Creating Discrete-Time Models” on page 1-24). In this section you can also read about how to specify transfer functions consisting of pure gains.

SISO Transfer Function Models

A continuous-time SISO transfer function

$$h(s) = \frac{n(s)}{d(s)}$$

is characterized by its numerator $n(s)$ and denominator $d(s)$, both polynomials of the Laplace variable s .

There are two ways to specify SISO transfer functions:

- Using the `tf` command
- As rational expressions in the Laplace variable s

To specify a SISO transfer function model $h(s) = n(s)/d(s)$ using the `tf` command, type

```
h = tf(num,den)
```

where `num` and `den` are row vectors listing the coefficients of the polynomials $n(s)$ and $d(s)$, respectively, when these polynomials are ordered in *descending* powers of s . The resulting variable `h` is a TF object containing the numerator and denominator data.

For example, you can create the transfer function $h(s) = s/(s^2 + 2s + 10)$ by typing

```
h = tf([1 0],[1 2 10])
```

This command results in

```
Transfer function:
      s
-----
s^2 + 2 s + 10
```

Note the customized display used for TF objects.

You can also specify transfer functions as rational expressions in the Laplace variable s by:

1 Defining the variable `s` as a special TF model

```
s = tf('s');
```

2 Entering your transfer function as a rational expression in `s`

For example, once `s` is defined with `tf` as in **1**,

```
H = s/(s^2 + 2*s +10);
```

produces the same transfer function as

```
h = tf([1 0],[1 2 10]);
```

Note You need only define the variable s as a TF model once. All of the subsequent models you create using rational expressions of s are specified as TF objects, unless you convert the variable s to ZPK. See “Model Conversion” on page 1-46 for more information.

MIMO Transfer Function Models

MIMO transfer functions are two-dimensional arrays of elementary SISO transfer functions. There are several ways to specify MIMO transfer function models, including:

- Concatenation of SISO transfer function models
- Using `tf` with cell array arguments

Consider the rational transfer matrix

$$H(s) = \begin{bmatrix} \frac{s-1}{s+1} \\ \frac{s+2}{s^2+4s+5} \end{bmatrix}$$

You can specify $H(s)$ by concatenation of its SISO entries. For instance,

```
h11 = tf([1 -1],[1 1]);  
h21 = tf([1 2],[1 4 5]);
```

or, equivalently,

```
s = tf('s')  
h11 = (s-1)/(s+1);  
h21 = (s+2)/(s^2+4*s+5);
```

can be concatenated to form $H(s)$.

```
H = [h11; h21]
```

This syntax mimics standard matrix concatenation and tends to be easier and more readable for MIMO systems with many inputs and/or outputs. See “Model Interconnection Functions” on page 2-17 for more details on concatenation operations for LTI systems.

Alternatively, to define MIMO transfer functions using `tf`, you need two cell arrays (say, `N` and `D`) to represent the sets of numerator and denominator polynomials, respectively. See Structures and Cell Arrays in the MATLAB documentation for more details on cell arrays.

For example, for the rational transfer matrix $\mathbf{H}(s)$, the two cell arrays `N` and `D` should contain the row-vector representations of the polynomial entries of

$$\mathbf{N}(s) = \begin{bmatrix} s - 1 \\ s + 2 \end{bmatrix} \quad \mathbf{D}(s) = \begin{bmatrix} s + 1 \\ s^2 + 4s + 5 \end{bmatrix}$$

You can specify this MIMO transfer matrix $\mathbf{H}(s)$ by typing

```
N = {[1 -1];[1 2]}; % cell array for N(s)
D = {[1 1];[1 4 5]}; % cell array for D(s)
H = tf(N,D)
```

These commands result in

```
Transfer function from input to output...
      s - 1
#1:  -----
      s + 1

           s + 2
#2:  -----
      s^2 + 4 s + 5
```

Notice that both `N` and `D` have the same dimensions as \mathbf{H} . For a general MIMO transfer matrix $\mathbf{H}(s)$, the cell array entries `N{i, j}` and `D{i, j}` should be row-vector representations of the numerator and denominator of $\mathbf{H}_{ij}(s)$, the ij th entry of the transfer matrix $\mathbf{H}(s)$.

Pure Gains

You can use `tf` with only one argument to specify simple gains or gain matrices as TF objects. For example,

```
G = tf([1 0;2 1])
```

produces the gain matrix

$$G = \begin{bmatrix} 1 & 0 \\ 2 & 1 \end{bmatrix}$$

while

```
E = tf
```

creates an empty transfer function.

Zero-Pole-Gain Models

This section explains how to specify continuous-time SISO and MIMO zero-pole-gain models. The specification for discrete-time zero-pole-gain models is a simple extension of the continuous-time case. See “Creating Discrete-Time Models” on page 1-24.

SISO Zero-Pole-Gain Models

Continuous-time SISO zero-pole-gain models are of the form

$$h(s) = k \frac{(s - z_1) \dots (s - z_m)}{(s - p_1) \dots (s - p_n)}$$

where k is a real- or complex-valued scalar (the *gain*), and z_1, \dots, z_m and p_1, \dots, p_n are the real or complex conjugate pairs of zeros and poles of the transfer function $h(s)$. This model is closely related to the transfer function representation: the zeros are simply the numerator roots, and the poles, the denominator roots.

There are two ways to specify SISO zero-pole-gain models:

- Using the `zpk` command
- As rational expressions in the Laplace variable s

The syntax to specify ZPK models directly using `zpk` is

```
h = zpk(z,p,k)
```

where z and p are the vectors of zeros and poles, and k is the gain. This produces a ZPK object h that encapsulates the z , p , and k data. For example, typing

```
h = zpk(0, [1-i 1+i 2], -2)
```

produces

```
Zero/pole/gain:
-2 s
-----
(s-2) (s^2 - 2s + 2)
```

You can also specify zero-pole-gain models as rational expressions in the Laplace variable s by:

1 Defining the variable s as a ZPK model

```
s = zpk('s')
```

2 Entering the transfer function as a rational expression in s .

For example, once s is defined with `zpk`,

```
H = -2s/((s - 2)*(s^2 + 2*s + 2));
```

returns the same ZPK model as

```
h = zpk([0], [2 -1-i -1+i ], -2);
```

Note You need only define the ZPK variable s once. All subsequent rational expressions of s will be ZPK models, unless you convert the variable s to TF. See “Model Conversion” on page 1-46 for more information on conversion to other model types.

MIMO Zero-Pole-Gain Models

Just as with TF models, you can also specify a MIMO ZPK model by concatenation of its SISO entries (see “Model Interconnection Functions” on page 2-17).

You can also use the command `zpk` to specify MIMO ZPK models. The syntax to create a p -by- m MIMO zero-pole-gain model using `zpk` is

$$H = \text{zpk}(Z,P,K)$$

where

- Z is the p -by- m cell array of zeros ($Z\{i, j\}$ = zeros of $H_{ij}(s)$)
- P is the p -by- m cell array of poles ($P\{i, j\}$ = poles of $H_{ij}(s)$)
- K is the p -by- m matrix of gains ($K(i, j)$ = gain of $H_{ij}(s)$)

For example, typing

$$Z = \{[], -5; [1-i \ 1+i] \ []\};$$

$$P = \{0, [-1 \ -1]; [1 \ 2 \ 3], []\};$$

$$K = [-1 \ 3; 2 \ 0];$$

$$H = \text{zpk}(Z,P,K)$$

creates the two-input/two-output zero-pole-gain model

$$H(s) = \begin{bmatrix} \frac{-1}{s} & \frac{3(s+5)}{(s+1)^2} \\ \frac{2(s^2-2s+2)}{(s-1)(s-2)(s-3)} & 0 \end{bmatrix}$$

Notice that you use [] as a place holder in Z (or P) when the corresponding entry of $H(s)$ has no zeros (or poles).

State-Space Models

State-space models rely on linear differential or difference equations to describe the system dynamics. Continuous-time models are of the form

$$\begin{aligned} \frac{dx}{dt} &= Ax + Bu \\ y &= Cx + Du \end{aligned}$$

where x is the state vector and u and y are the input and output vectors. Such models may arise from the equations of physics, from state-space identification, or by state-space realization of the system transfer function.

Use the command `ss` to create state-space models

$$\text{sys} = \text{ss}(A, B, C, D)$$

For a model with N_x states, N_y outputs, and N_u inputs

- A is an N_x -by- N_x real- or complex-valued matrix.
- B is an N_x -by- N_u real- or complex-valued matrix.
- C is an N_y -by- N_x real- or complex-valued matrix.
- D is an N_y -by- N_u real- or complex-valued matrix.

This produces a SS object `sys` that stores the state-space matrices **A**, **B**, **C**, and **D**. For models with a zero D matrix, you can use `D = 0` (zero) as a shorthand for a zero matrix of the appropriate dimensions.

As an illustration, consider the following simple model of an electric motor.

$$\frac{d^2\theta}{dt^2} + 2\frac{d\theta}{dt} + 5\theta = 3I$$

where θ is the angular displacement of the rotor and I the driving current. The relation between the input current $u = I$ and the angular velocity $y = d\theta/dt$ is described by the state-space equations

$$\begin{aligned} \frac{dx}{dt} &= Ax + Bu \\ y &= Cx \end{aligned}$$

where

$$x = \begin{bmatrix} \theta \\ \frac{d\theta}{dt} \end{bmatrix} \quad A = \begin{bmatrix} 0 & 1 \\ -5 & -2 \end{bmatrix} \quad B = \begin{bmatrix} 0 \\ 3 \end{bmatrix} \quad C = [0 \ 1]$$

This model is specified by typing

```
sys = ss([0 1; -5 -2],[0;3],[0 1],0)
```

This command results in

```
a =
           x1           x2
x1           0          1.00000
x2        -5.00000      -2.00000

b =
           u1
x1           0
x2          3.00000

c =
           x1           x2
y1           0          1.00000
```

Frequency Response Data (FRD) Models

In some instances, you may only have sampled frequency response data, rather than a transfer function or state-space model for the system you want to analyze or control. For information on frequency response analysis of linear systems, see Chapter 8 of [1][1].

For example, suppose the frequency response function for the SISO system you want to model is $G(w)$. Suppose, in addition, that you perform an experiment to evaluate $G(w)$ at a fixed set of frequencies, w_1, w_2, \dots, w_n . You can do this by driving the system with a sequence of sinusoids at each of these frequencies, as depicted below.

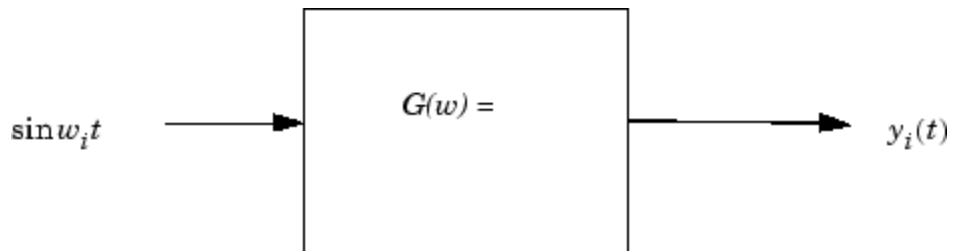

Here w_i is the input frequency of each sinusoid, $i = 1 \dots n$, and $G(w) = |G(w)| \exp(j \angle G(w))$. The steady state output response of this system satisfies

$$y_i(t) = |G(w_i)| \sin(w_i t + \angle G(w_i)); \quad i = 1 \dots n$$

A *frequency response data (FRD) object* is a model form you can use to store frequency response data (complex frequency response, along with a corresponding vector of frequency points) that you obtain either through simulations or experimentally. In this example, the frequency response data is obtained from the set of response pairs: $\{(G(w_i), w_i)\}, i = 1 \dots n$.

Once you store your data in an FRD model, you can treat it as an LTI model, and manipulate an FRD model in most of the same ways you manipulate TF, SS, and ZPK models.

The basic syntax for creating a SISO FRD model is

```
sys = frd(response,frequencies,units)
```

where

- `frequencies` is a real vector of length N_f .
- `response` is a vector of length N_f of complex frequency response values for these frequencies.
- `units` is an optional string for the units of frequency: either 'rad/s' (default) or 'Hz'

For example, the MAT-file `LTIexamples.mat` contains a frequency vector `freq`, and a corresponding complex frequency response data vector `respG`. To load this frequency-domain data and construct an FRD model, type

```
load LTIexamples
sys = frd(respG,freq)
```

Continuous-time frequency response with 1 output and 1 input at 5 frequency points.

From input 1 to:		output 1
Frequency(rad/s)		
-----		-----
1	-0.812505	-0.000312i
2	-0.092593	-0.462963i
4	-0.075781	-0.001625i
5	-0.043735	-0.000390i

The syntax for creating a MIMO FRD model is the same as for the SISO case, except that `response` is a p -by- m -by- N_f multidimensional array, where p is the number of outputs, m is the number of inputs, and N_f is the number of frequency data points (the length of `frequency`).

The following table summarizes the complex-valued response data format for FRD models.

Data Format for the Argument Response in FRD Models

Model Structure	Response Data Format
SISO model	Vector of length N_f for which $\text{response}(i)$ is the frequency response at the frequency $\text{frequency}(i)$
MIMO model with N_y outputs and N_u inputs	N_y -by- N_u -by- N_f multidimensional array for which $\text{response}(i, j, k)$ specifies the frequency response from input j to output i at frequency $\text{frequency}(k)$
S_1 -by-...-by- S_n array of models with N_y outputs and N_u inputs	N_y -by- N_u -by- S_1 -by-...-by- S_n multidimensional array, for which $\text{response}(i, j, k, :)$ specifies the array of frequency response data from input j to output i at frequency $\text{frequency}(k)$

Creating Discrete-Time Models

Creating discrete-time models is very much like creating continuous-time models, except that you must also specify a sampling period or *sample time* for discrete-time models. The sample time value should be scalar and expressed in seconds. You can also use the value -1 to leave the sample time unspecified.

To specify discrete-time LTI models using `tf`, `zpk`, `ss`, or `frd`, simply append the desired sample time value T_s to the list of inputs.

```
sys1 = tf(num,den,Ts)
sys2 = zpk(z,p,k,Ts)
sys3 = ss(a,b,c,d,Ts)
sys4 = frd(response,frequency,Ts)
```

For example,

```
h = tf([1 -1],[1 -0.5],0.1)
```

creates the discrete-time transfer function $h(z) = (z - 1)/(z - 0.5)$ with sample time 0.1 seconds, and

```
sys = ss(A,B,C,D,0.5)
```

specifies the discrete-time state-space model

$$\begin{aligned}x[n + 1] &= Ax[n] + Bu[n] \\y[n] &= Cx[n] + Du[n]\end{aligned}$$

with sampling period 0.5 second. The vectors $x[n]$, $u[n]$, $y[n]$ denote the values of the state, input, and output vectors at the n th sample.

By convention, the sample time of continuous-time models is $T_s = 0$. Setting $T_s = -1$ leaves the sample time of a discrete-time model unspecified. For example,

```
h = tf([1 -0.2],[1 0.3],-1)
```

produces

Transfer function:

```
z - 0.2
-----
z + 0.3
```

Sampling time: unspecified

Note Do not simply omit T_s in this case. This would make h a continuous-time transfer function.

If you forget to specify the sample time when creating your model, you can still set it to the correct value by reassigning the LTI property T_s . See “Sample Time” on page 1-40 for more information on setting this property.

Discrete-Time TF and ZPK Models

You can specify discrete-time TF and ZPK models using `tf` and `zpk` as indicated above. Alternatively, it is often convenient to specify such models by:

- 1 Defining the variable z as a particular discrete-time TF or ZPK model with the appropriate sample time

2 Entering your TF or ZPK model directly as a rational expression in z .

This approach parallels the procedure for specifying continuous-time TF or ZPK models using rational expressions. This procedure is described in “SISO Transfer Function Models” on page 1-12 and “SISO Zero-Pole-Gain Models” on page 1-16.

For example,

```
z = tf('z', 0.1);
H = (z+2)/(z^2 + 0.6*z + 0.9);
```

creates the same TF model as

```
H = tf([1 2], [1 0.6 0.9], 0.1);
```

Similarly,

```
z = zpks('z', 0.1);
H = [z/(z+0.1)/(z+0.2) ; (z^2+0.2*z+0.1)/(z^2+0.2*z+0.01)]
```

produces the single-input, two-output ZPK model

Zero/pole/gain from input to output...

```

          z
#1:  -----
      (z+0.1) (z+0.2)

      (z^2 + 0.2z + 0.1)
#2:  -----
      (z+0.1)^2
```

Sampling time: 0.1

Note that:

- The syntax `z = tf('z')` is equivalent to `z = tf('z', -1)` and leaves the sample time unspecified. The same applies to `z = zpks('z')`.

- Once you have defined z as indicated above, any rational expressions in z creates a discrete-time model of the same type and with the same sample time as z .

Discrete Transfer Functions in DSP Format

In digital signal processing (DSP), it is customary to write discrete transfer functions as rational expressions in z^{-1} and to order the numerator and denominator coefficients in *ascending powers of z^{-1}* . For example, the numerator and denominator of

$$H(z^{-1}) = \frac{1 + 0.5z^{-1}}{1 + 2z^{-1} + 3z^{-2}}$$

would be specified as the row vectors `[1 0.5]` and `[1 2 3]`, respectively. When the numerator and denominator have different degrees, this convention clashes with the "*descending powers of z* " convention assumed by `tf` (see "Transfer Function Models" on page 1-12, or `tf`). For example,

```
h = tf([1 0.5],[1 2 3])
```

produces the transfer function

$$\frac{z + 0.5}{z^2 + 2z + 3}$$

which differs from $H(z^{-1})$ by a factor z .

To avoid such convention clashes, you can use a separate function `filt` dedicated to the DSP-like specification of transfer functions. Its syntax is

```
h = filt(num,den)
```

for discrete transfer functions with unspecified sample time, and

```
h = filt(num,den,Ts)
```

to further specify the sample time T_s . This function creates TF objects just like `tf`, but expects `num` and `den` to list the numerator and denominator coefficients in *ascending powers of z^{-1}* . For example, typing

```
h = filt([1 0.5],[1 2 3])
```

produces

```
Transfer function:
      1 + 0.5 z^-1
-----
      1 + 2 z^-1 + 3 z^-2

Sampling time: unspecified
```

You can also use `filt` to specify MIMO transfer functions in z^{-1} . Just as for `tf`, the input arguments `num` and `den` are then cell arrays of row vectors of appropriate dimensions (see “Transfer Function Models” on page 1-12 for details). Note that each row vector should comply with the “ascending powers of z^{-1} ” convention.

Data Retrieval

The functions `tf`, `zpk`, `ss`, and `frd` pack the model data and sample time in a single LTI object. Conversely, the following commands provide convenient data retrieval for any type of TF, SS, or ZPK model `sys`, or FRD model `sysfr`.

```
[num,den,Ts] = tfdata(sys)    % Ts = sample time
[z,p,k,Ts] = zpkdata(sys)
[a,b,c,d,Ts] = ssdata(sys)
[a,b,c,d,e,Ts] = dssdata(sys)
[response,frequency,Ts] = frdata(sysfr)
```

Note that:

- `sys` can be any type of LTI object, *except* an FRD model
- `sysfr`, the input argument to `frdata`, can only be an FRD model

You can use any variable names you want in the output argument list of any of these functions.

The output arguments `num` and `den` assigned to `tfdata`, and `z` and `p` assigned to `zpkdata`, are cell arrays, even in the SISO case. These cell arrays have as many rows as outputs, as many columns as inputs, and their *ij*th entry

specifies the transfer function from the j th input to the i th output. For example,

```
H = [tf([1 -1],[1 2 10]) , tf(1,[1 0])]
```

creates the one-output/two-input transfer function

$$H(s) = \begin{bmatrix} \frac{s-1}{s^2+2s+10} & \frac{1}{s} \end{bmatrix}$$

Typing

```
[num,den] = tfdata(H);
num{1,1}, den{1,1}
```

displays the coefficients of the numerator and denominator of the first input channel.

```
ans =
    0     1    -1
ans =
    1     2    10
```

Note that the same result is obtained using

```
H.num{1,1}, H.den{1,1}
```

See “Direct Property Referencing Using Dot Notation” on page 1-38 for more information about this syntax.

To obtain the numerator and denominator of SISO systems directly as row vectors, use the syntax

```
[num,den,Ts] = tfdata(sys,'v')
```

For example, typing

```
sys = tf([1 3],[1 2 5]);
[num,den] = tfdata(sys,'v')
```

produces

num =

0 1 3

den =

1 2 5

Similarly,

```
[z,p,k,Ts] = zpndata(sys,'v')
```

returns the zeros, z , and the poles, p , as *vectors* for SISO systems.

LTI Properties

In this section...

“What are LTI Properties?” on page 1-31

“Generic LTI Properties” on page 1-31

“Model-Specific Properties” on page 1-33

“Setting LTI Properties” on page 1-35

“Accessing Property Values Using get” on page 1-37

“Direct Property Referencing Using Dot Notation” on page 1-38

“Additional Insight into LTI Properties” on page 1-40

What are LTI Properties?

The previous section shows how to create LTI objects that encapsulate the model data and sample time. You also have the option to attribute additional information, such as the input names or notes on the model history, to LTI objects. This section gives a complete overview of the *LTI properties*, i.e., the various pieces of information that can be attached to the TF, ZPK, SS, and FRD objects. Type `helpLTIprops` for online help on available LTI properties.

From a data structure standpoint, the LTI properties are the various fields in the TF, ZPK, SS, and FRD objects. These fields have names (the *property names*) and are assigned values (the *property values*). We distinguish between *generic properties*, common to all four types of LTI objects, and *model-specific properties* that pertain only to one particular type of model.

Generic LTI Properties

The generic properties are those shared by all four types of LTI models (TF, ZPK, SS, and FRD objects). They are listed in the table below.

LTI Properties Common to All LTI Objects

Property Name	Description	Data Type
InputDelay	Input delay(s)	Vector

LTI Properties Common to All LTI Objects (Continued)

Property Name	Description	Data Type
InputGroup	Input channel groups	Structure
InputName	Input channel names	Cell vector of strings
Notes	Notes on the model history	Text
OutputDelay	Output delay(s)	Vector
OutputGroup	Output channel groups	Structure
OutputName	Output channel names	Cell vector of strings
Ts	Sample time	Scalar
Userdata	Additional data	Arbitrary

The sample time property `Ts` keeps track of the sample time (in seconds) of discrete-time systems. By convention, `Ts` is 0 (zero) for continuous-time systems, and `Ts` is -1 for discrete-time systems with unspecified sample time. `Ts` is always a scalar, even for MIMO systems.

The `InputDelay`, `OutputDelay`, `ioDelay` and `InternalDelay` properties allow you to specify time delays in the input or output channels, or for each input/output pair. Their default value is zero (no delay). See “Time Delays” on page 1-49 for details on modeling delays.

The `InputName` and `OutputName` properties enable you to give names to the *individual* input and output channels. The value of each of these properties is a cell vector of strings with as many cells as inputs or outputs. For example, the `OutputName` property is set to

```
{ 'temperature' ; 'pressure' }
```

for a system with two outputs labeled `temperature` and `pressure`. The default value is a cell of empty strings.

Using the `InputGroup` and `OutputGroup` properties of LTI objects, you can create different groups of input or output channels, and assign names to the groups. For example, you may want to designate the first four inputs of a

five-input model as **controls**, and the last input as **noise**. See “Input Groups and Output Groups” on page 1-43 for more information.

Finally, **Notes** and **Userdata** are available to store additional information on the model. The **Notes** property is dedicated to any text you want to supply with your model, while the **Userdata** property can accommodate arbitrary user-supplied data. They are both empty by default.

For more detailed information on how to use LTI properties, see “Additional Insight into LTI Properties” on page 1-40.

Model-Specific Properties

The remaining LTI properties are specific to one of the four model types (TF, ZPK, SS, or FRD). For single LTI models, these are summarized in the following four tables. The property values differ for LTI arrays. See **set** for more information on these values.

TF-Specific Properties

Property Name	Description	Data Type
den	Denominator(s)	Real cell array of row vectors
num	Numerator(s)	Real cell array of row vectors
ioDelay	I/O delay(s)	Matrix
Variable	Transfer function variable	String 's', 'p', 'z', 'q', or 'z^-1'

ZPK-Specific Properties

Property Name	Description	Data Type
z	Zeros	Cell array of column vectors

Property Name	Description	Data Type
p	Poles	Cell array of column vectors
k	Gains	Two-dimensional real matrix
Variable	Transfer function variable	String 's', 'p', 'z', 'q', or 'z ⁻¹ '
ioDelay	I/O delay(s)	Matrix

SS-Specific Properties

Property Name	Description	Data Type
a	State matrix A	2-D real matrix
b	Input-to-state matrix B	2-D real matrix
c	State-to-output matrix C	2-D real matrix
d	Feedthrough matrix D	2-D real matrix
e	Descriptor E matrix	2-D real matrix
InternalDelay	Internal delay(s)	Vector
StateName	State names	Cell vector of strings
Scaled	When false, numerical algorithms rescale the state vector to improve accuracy. When true, the model is marked as already scaled and no rescaling occurs.	0 for false, 1 for true

FRD-Specific Properties

Property Name	Description	Data Type
Frequency	Frequency data points	Real-valued vector
ResponseData	Frequency response	Complex-valued multidimensional array
Units	Units for frequency	String 'rad/s' or 'Hz'

Most of these properties are dedicated to storing the model data. Note that the \mathbf{E} matrix is set to `[]` (the empty matrix) for standard state-space models, a storage-efficient shorthand for the true value $\mathbf{E} = \mathbf{I}$.

The `Variable` property is only an attribute of TF and ZPK objects. This property defines the frequency variable of transfer functions. The default values are 's' (Laplace variable s) in continuous time and 'z' (Z-transform variable z) in discrete time. Alternative choices include 'p' (equivalent to s) and 'q' or 'z⁻¹' for the reciprocal $q = z^{-1}$ of the z variable. The influence of the variable choice is mostly limited to the display of TF or ZPK models. One exception is the specification of discrete-time transfer functions with `tf` (see `tf` for details).

Note that `tf` produces the same result as `filt` when the `Variable` property is set to 'z⁻¹' or 'q'.

Finally, the `StateName` property is analogous to the `InputName` and `OutputName` properties and keeps track of the state names in state-space models.

Setting LTI Properties

There are three ways to specify LTI property values:

- You can set properties when creating LTI models with `tf`, `zpk`, `ss`, or `frd`.
- You can set or modify the properties of an existing LTI model with `set`.
- You can also set property values using structure-like assignments.

This section discusses the first two options. See “Direct Property Referencing Using Dot Notation” on page 1-38 for details on the third option.

The function `set` for LTI objects follows the same syntax as its Handle Graphics counterpart. Specifically, each property is updated by a pair of arguments

PropertyName, *PropertyValue*

where

- *PropertyName* is a string specifying the property name. You can type the property name without regard for the case (upper or lower) of the letters in the name. Actually, you need only type any abbreviation of the property name that uniquely identifies the property. For example, 'user' is sufficient to refer to the `Userdata` property.
- *PropertyValue* is the value to assign to the property (see `set` for details on admissible property values).

As an illustration, consider the following simple SISO model for a heating system with an input delay of 0.3 seconds, an input called "energy," and an output called "temperature."

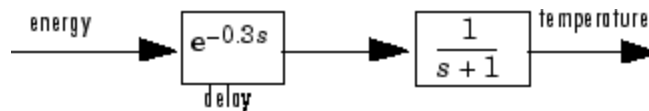

A Simple Heater Model

You can use a TF object to represent this delay system, and specify the time delay, the input and output names, and the model history by setting the corresponding LTI properties. You can either set these properties directly when you create the LTI model with `tf`, or by using the `set` command.

For example, you can specify the delay directly when you create the model, and then use the `set` command to assign `InputName`, `OutputName`, and `Notes` to `sys`.

```

sys = tf(1,[1 1], 'Inputdelay',0.3);
set(sys, 'inputname', 'energy', 'outputname', 'temperature', ...
      'notes', 'A simple heater model')
  
```

Finally, you can also use the `set` command to obtain a listing of all settable properties for a given LTI model type, along with valid values for these properties. For the transfer function `sys` created above

```
set(sys)
```

produces

```
num: Ny-by-Nu cell array of row vectors (Nu = no. of inputs)
den: Ny-by-Nu cell array of row vectors (Ny = no. of outputs)
ioDelay: Ny-by-Nu array of delays for each I/O pair
Variable: [ 's' | 'p' | 'z' | 'z^-1' | 'q' ]
Ts: Scalar (sample time in seconds)
InputDelay: Nu-by-1 vector
OutputDelay: Ny-by-1 vector
InputName: Nu-by-1 cell array of strings
OutputName: Ny-by-1 cell array of strings
InputGroup: structure with one field per channel group.
OutputGroup: structure with one field per channel group.
Name: String
Notes: Text
UserData: Arbitrary
```

Accessing Property Values Using `get`

You access the property values of an LTI model `sys` with `get`. The syntax is

```
PropertyValue = get(sys,PropertyName)
```

where the string *PropertyName* is either the full property name, or any abbreviation with enough characters to identify the property uniquely. For example, typing

```
h = tf(100,[1 5 100],'inputname','voltage',...
        'outputn','current',...
        'notes','A simple circuit')
get(h,'notes')
```

produces

```
ans =
```

```
'A simple circuit'
```

To display all of the properties of an LTI model `sys` (and their values), use the syntax `get(sys)`. In this example,

```
get(h)
```

produces

```
        num: {[0 0 100]}
        den: {[1 5 100]}
    ioDelay: 0
    Variable: 's'
         Ts: 0
    InputDelay: 0
    OutputDelay: 0
    InputName: {'voltage'}
    OutputName: {'current'}
    InputGroup: [1x1 struct]
    OutputGroup: [1x1 struct]
         Name: ''
         Notes: {'A simple circuit'}
    UserData: []
```

Notice that default (output) values have been assigned to any LTI properties in this list that you have not specified.

Finally, you can also access property values using direct structure-like referencing. This topic is explained in “Direct Property Referencing Using Dot Notation” on page 1-38

Direct Property Referencing Using Dot Notation

An alternative way to query/modify property values is by structure-like referencing. Recall that LTI objects are basic MATLAB structures except for the additional flag that marks them as TF, ZPK, SS, or FRD objects (see “LTI Objects” on page 1-7). The field names for LTI objects are the property names, so you can retrieve or modify property values with the structure-like syntax.

```

PropertyValue = sys.PropertyName    % gets property value
sys.PropertyName = PropertyValue    % sets property value

```

These commands are respectively equivalent to

```

PropertyValue = get(sys, 'PropertyName')
set(sys, 'PropertyName', PropertyValue)

```

For example, type

```

sys = ss(1,2,3,4, 'InputName', 'u');
sys.a

```

and you get the value of the property "a" for the state-space model `sys`.

```

ans =
     1

```

Similarly,

```

sys.a = -1;

```

resets the state transition matrix for `sys` to -1.

Unlike standard MATLAB structures, you do not need to type the entire field name or use upper-case characters. You only need to type the minimum number of characters sufficient to identify the property name uniquely. Thus either of the commands

```

sys.InputName
sys.inputn

```

produces

```

ans =
     'u'

```

Any valid syntax for structures extends to LTI objects. For example, given the TF model $h(p) = 1/p$

```
h = tf(1,[1,0], 'variable', 'p');
```

you can reset the numerator to $p + 2$ by typing

```
h.num{1} = [1 2];
```

or equivalently, with

```
h.num{1}(2) = 2;
```

Additional Insight into LTI Properties

By reading this section, you can learn more about using the `Ts`, `InputName`, `OutputName`, `InputGroup`, and `OutputGroup` LTI properties through a set of examples. For basic information on `Notes` and `Userdata`, see “Generic LTI Properties” on page 1-31. For detailed information on the use of `InputDelay`, `OutputDelay`, `ioDelay`, and `InternalDelay`, see “Time Delays” on page 1-49.

Sample Time

The sample time property `Ts` is used to specify the sampling period (in seconds) for either discrete-time or discretized continuous-time LTI models. Suppose you want to specify

$$H(z) = \frac{z}{2z^2 + z + 1}$$

as a discrete-time transfer function model with a sampling period of 0.5 seconds. To do this, type

```
h = tf([1 0],[2 1 1],0.5);
```

This sets the `Ts` property to the value 0.5, as is confirmed by

```
h.Ts
ans =
    0.5000
```

For continuous-time models, the sample time property `Ts` is 0 by convention. For example, type

```

h = tf(1,[1 0]);
get(h,'Ts')

ans =
     0

```

To leave the sample time of a discrete-time LTI model unspecified, set `Ts` to `-1`. For example,

```
h = tf(1,[1 -1],-1)
```

produces

```

Transfer function:
      1
-----
z - 1

Sampling time: unspecified

```

The same result is obtained by using the `Variable` property.

```
h = tf(1,[1 -1],'var','z')
```

In operations that combine several discrete-time models, all *specified* sample times must be identical, and the resulting discrete-time model inherits this common sample time. The sample time of the resultant model is unspecified if all operands have unspecified sample times. With this inheritance rule for `Ts`, the following two models are equivalent.

```
tf(0.1,[1 -1],0.1) + tf(1,[1 0.5],-1)
```

and

```
tf(0.1,[1 -1],0.1) + tf(1,[1 0.5],0.1)
```

Note that

```
tf(0.1,[1 -1],0.1) + tf(1,[1 0.5],0.5)
```

returns an error message.

```
??? Error using ==> lti/plus
In SYS1+SYS2, both models must have the same sample time.
```

Caution Resetting the sample time of a continuous-time LTI model `sys` from zero to a nonzero value does *not* discretize the original model `sys`. The command

```
set(sys, 'Ts', 0.1)
```

only affects the `Ts` property and does not alter the remaining model data. Use `c2d` and `d2c` to perform continuous-to-discrete and discrete-to-continuous conversions. For example, use

```
sysd = c2d(sys, 0.1)
```

to discretize a continuous system `sys` at a 10Hz sampling rate. Use `d2d` to change the sample time of a discrete-time system and resample it.

Input Names and Output Names

You can use the `InputName` and `OutputName` properties (in short, I/O names) to assign names to any or all of the input and output channels in your LTI model.

For example, you can create a SISO model with input `thrust`, output `velocity`, and transfer function $H(p) = 1/(p + 10)$ by typing

```
h = tf(1, [1 10]);
set(h, 'inputname', 'thrust', 'outputname', 'velocity', ...
      'variable', 'p')
```

Equivalently, you can set these properties directly by typing

```
h = tf(1, [1 10], 'inputname', 'thrust', ...
      'outputname', 'velocity', ...
      'variable', 'p')
```

This produces

```
Transfer function from input "thrust" to output "velocity":
1
```



```

-----
p + 10

```

Note how the display reflects the input and output names and the variable selection.

In the MIMO case, use cell vectors of strings to specify input or output channel names. For example, type

```

num = {3 , [1 2]};
den = {[1 10] , [1 0]};
H = tf(num,den);          % H(s) has one output and two inputs

set(H,'inputname',{ 'temperature' ; 'pressure' })

```

The specified input names appear in the display of H.

```

Transfer function from input "temperature" to output:
      3
-----
s + 10

Transfer function from input "pressure" to output:
s + 2
-----
s

```

To leave certain names undefined, use the empty string '' as in

```

H = tf(num,den,'inputname',{ 'temperature' ; '' })

```

Input Groups and Output Groups

In many applications, you may want to create several (distinct or intersecting) groups of input or output channels and name these groups. For example, you may want to label one set of input channels as `noise` and another set as `controls`.

To see how input and output groups (I/O groups) work:

- 1** Create a random state-space model with one state, three inputs, and three outputs.
- 2** Assign the first two inputs to a group named `controls`, the first output to a group named `temperature`, and the last two outputs to a group named `measurements`. Note that both `InputGroup` and `OutputGroup` are structures.

To do this, type

```
h = rss(1,3,3);
h.InputGroup.controls=[1 2];
h.OutputGroup.temperature = [1];
h.OutputGroup.measurements = [2 3];
h
```

These commands result in a state-space model of the following form.

```
a =
      x1      x2      x3
x1 -2.809   1.967  -1.82
x2 -2.432  -2.042   0.8313
x3  1.125   1.655  -1.017

b =
      u1      u2      u3
x1 -0.7829   0.4801   0
x2  0         0.6682   2.309
x3 -0.2512  -0.07832  0.5246

c =
      x1      x2      x3
y1 -0.01179   0      -0.2762
y2  0.9131   0.4855   1.276
y3  0.05594  -0.005005  1.863

d =
```

	u1	u2	u3
y1	-0.5226	0	0
y2	0.1034	0	0.2617
y3	-0.8076	0	0

Input groups:

Name	Channels
controls	1,2

Output groups:

Name	Channels
temperature	1
measurements	2,3

Continuous-time model.

Similarly, you can add or delete channels from an existing input or output group by redefining the group members. For example,

```
h.OutputGroup.temperature=[1 2]
```

adds the second output to the temperature group. To delete a channel from a group, just respecify it. For example,

```
h.OutputGroup.temperature=[1]
```

restores the original temperature group by deleting output #2 from the group.

Model Conversion

In this section...

“Available Model Formats” on page 1-46

“Explicit Conversion” on page 1-46

“Automatic Conversion” on page 1-47

“Caution About Model Conversions” on page 1-48

Available Model Formats

You can use the following LTI model formats:

- TF
- ZPK
- SS
- FRD

This section shows how to convert models from one format to the other.

Explicit Conversion

Model conversions are performed by `tf`, `ss`, `zpk`, and `frd`. Given any TF, SS, or ZPK model `sys`, the syntax for conversion to another model type is

```
sys = tf(sys)           % Conversion to TF
sys = zpk(sys)          % Conversion to ZPK
sys = ss(sys)           % Conversion to SS
sys = frd(sys, frequency) % Conversion to FRD
```

Notice that FRD models can't be converted to the other model types. In addition, you must also include a vector of frequencies (`frequency`) as an input argument when converting to an FRD model.

For example, you can convert the state-space model

```
sys = ss(-2,1,1,3)
```

to a zero-pole-gain model by typing

```
zpk(sys)
```

This command results in

```
Zero/pole/gain:
3 (s+2.333)
-----
(s+2)
```

Note that the transfer function of a state-space model with data (A, B, C, D) is

$$H(s) = D + C(sI - A)^{-1}B$$

for continuous-time models, and

$$H(z) = D + C(zI - A)^{-1}B$$

for discrete-time models.

Automatic Conversion

Some algorithms operate only on one type of LTI model. For example, the algorithm for zero-order-hold discretization with `c2d` can only be performed on state-space models. Similarly, commands like `tfdata` expect one particular type of LTI models (TF). For convenience, such commands automatically convert LTI models to the appropriate or required model type. For example, in

```
sys = ss(0,1,1,0)
[num,den] = tfdata(sys)
```

`tfdata` first converts the state-space model `sys` to an equivalent transfer function in order to return numerator and denominator data.

Conversions to state-space models are not uniquely defined. For this reason, automatic conversions to state space are disabled when the result depends on the choice of state coordinates, for example, in commands like `initial` or `kalman`.

Caution About Model Conversions

When manipulating or converting LTI models, keep in mind that:

- The three LTI model types TF, ZPK, and SS, are not equally well-suited for numerical computations. In particular, the accuracy of computations using high-order transfer functions is often poor. Therefore, it is often preferable to work with the state-space representation. In addition, it is often beneficial to balance and scale state-space models. You get this type of balancing automatically when you convert any TF or ZPK model to state space using `ss`.
- Conversions to the transfer function representation using `tf` may incur a loss of accuracy. As a result, the transfer function poles may noticeably differ from the poles of the original zero-pole-gain or state-space model.
- Conversions to state space are not uniquely defined in the SISO case, nor are they guaranteed to produce a minimal realization in the MIMO case. For a given state-space model `sys`,

```
ss(tf(sys))
```

may return a model with different state-space matrices, or even a different number of states in the MIMO case. Therefore, if possible, it is best to avoid converting back and forth between state-space and other model types.

Time Delays

In this section...

- “Supported Types of Delays” on page 1-49
- “Available Properties for Modeling Delays” on page 1-50
- “Input and Output Delays” on page 1-50
- “Specifying I/O Delays in MIMO Models” on page 1-53
- “Internal Delays” on page 1-55
- “Analyzing Systems With Delays” on page 1-59
- “Eliminating Time Delays: Padé Approximation” on page 1-65
- “Sensitivity Analysis” on page 1-68
- “Specifying Delays in Discrete-Time Models” on page 1-71
- “Discretization” on page 1-76
- “Functions That Support Internal Time Delays” on page 1-78
- “Functions That Do Not Support Internal Time Delays” on page 1-79
- “Inside Time Delay Models” on page 1-79

Supported Types of Delays

You can use Control System Toolbox tools to perform accurate analysis of LTI systems with time delays. Such systems are common, particularly in process control applications. You can create, manipulate, and analyze any LTI model with a finite number of delays.

Delays can occur at

- Inputs
- Outputs
- Between individual I/O pairs
- Internally (for example, inside a feedback loop)

Available Properties for Modeling Delays

Transfer function (TF), zero-pole-gain (ZPK), and frequency response data (FRD) objects have three properties for modeling delays:

- `InputDelay` — Specify delays at the inputs.
- `OutputDelay` — Specify delays at the outputs.
- `IODelay` — Specify independent transport delays for individual I/O pairs.

State-space (SS) objects have three properties as well:

- `InputDelay` — Specify delays at the inputs.
- `OutputDelay` — Specify delays at the outputs.
- `InternalDelay` — Keep track of delays when combining models with internal/external delays or closing feedback loops.

Since SS objects can keep track of internal delays, state-space representation is best suited for modeling and analyzing delay effects in control systems.

Input and Output Delays

The simplest type of delays are delays in the input and output channels. The `InputDelay` and `OutputDelay` properties let you specify such delays. Use the `InputDelay` property to specify delays at the model inputs and the `OutputDelay` property to specify delays at the outputs. For example, you can specify a first-order transfer function with deadtime (which is common in process control applications):

$$k(s) = \frac{e^{-2s}}{s+1}$$

```
s = tf('s');
sys = 1/(s+1);
sys.InputDelay = 2
```

Transfer function:

```
1
exp(-2*s) * -----
```

$$s + 1$$

creates a system with a 2 s. delay.

Likewise, use the `OutputDelay` property to specify output delays. For example:

```
sys.OutputDelay = 1.5;
```

Specifying Input and Output Delays in State-Space Models

You can also specify state-space models with delays at the inputs or outputs. For example,

$$\frac{dx}{dt} = -2x(t) + u(t - 1.8)$$

$$y(t) = 7x(t)$$

can be specified with

```
sys1=ss(-2,1,7,0,'InputDelay',1.8)
```

```
a =
      x1
x1  -2
```

```
b =
      u1
x1    1
```

```
c =
      x1
y1    7
```

```
d =
      u1
y1    0
```

Input delays (listed by channel): 1.8

Continuous-time model.

The model has an input delay of 1.8 s. Similarly, to create the model:

$$\frac{dx}{dt} = -2x(t) + u(t)$$
$$y(t) = 7x(t - 1.8)$$

with a 1.8 s. delay at the output, use:

```
sys2=ss(-2,1,7,0,'OutputDelay',1.8);  
sys2.OutputDelay  
ans =  
  
1.8000
```

Compare the step response of the two systems:

```
step(sys1,sys2);  
grid  
legend('System with input delay','System with output delay')
```

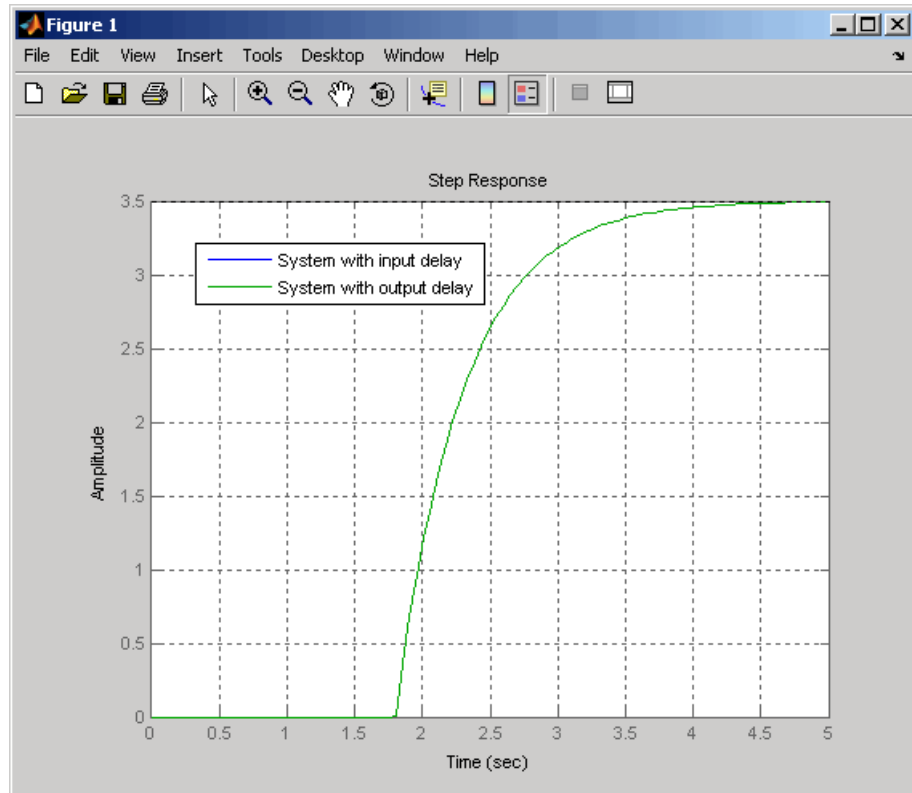

The response is exactly the same for both systems. The difference lies in state trajectories. Since the $y(t)$'s are equal,

$$x_1(t) = x_2(t - 1.8)$$

where x_1 is the state of sys1, and x_2 is the state of sys2.

Specifying I/O Delays in MIMO Models

You can also specify independent delays on each entry of a MIMO TF or ZPK model. Transport delays from a given input to a given output of a MIMO system are called *I/O delays*. For example, to create this 2-by-2 transfer function with four I/O delays:

$$H(s) = \begin{bmatrix} e^{-0.1s} \frac{2}{s} & e^{-0.3s} \frac{s+1}{s+10} \\ 10 & e^{-0.2s} \frac{s-1}{s+5} \end{bmatrix}$$

Use `exp` to specify the delays and apply them to each entry:

```
s=tf('s'); % Laplace variable
sys= exp(-s*[0.5 1.2; 0.3 0.9]).* ...
[s/(s+2) 3/(s^2+5); 2/(s^2+2*s+7) (s+7)/(s+9)];
Transfer function from input 1 to output...
```

```
          s
#1:  exp(-0.5*s) * ----
                s + 2
```

```
          2
#2:  exp(-0.3*s) * ----
                s^2 + 2 s + 7
```

Transfer function from input 2 to output...

```
          3
#1:  exp(-1.2*s) * ----
                s^2 + 5
```

```
          s + 7
#2:  exp(-0.9*s) * ----
                s + 9
```

Using the `ioDelay` Property to Specify Delays

You could also have specified the delays by setting the `ioDelay` property.

```
s=tf('s');
sys= [s/(s+2) 3/(s^2+5); ...
2/(s^2+2*s+7) (s+7)/(s+9)];
tau = [0.1 0.2; 0.3 0.9]; % Create I/O delay matrix.
sys.ioDelay = tau; % Add I/O delays to sys.
```

You can retrieve the I/O delay values using the following:

```
sys.ioDelay
ans =
    0.1000 0.2000
    0.3000 0.9000
```

Internal Delays

Using the `InputDelay`, `OutputDelay`, and `ioDelay` properties, you can model simple processes with transport delays, but you cannot model more complex situations, like a feedback loop with delays. In addition to the `InputDelay` and `OutputDelay` properties, state-space (SS) models have an `InternalDelay` property, that lets you model interconnection of systems with input, output, or I/O delays, including feedback loops with delays. You can use this feature to accurately model and analyze arbitrary linear systems with delays. Internal delays can arise from the following:

- Concatenating state-space models with input and output delays
- Feeding back a delayed signal
- Converting MIMO TF or ZPK models with I/O delays to state space

Using internal time delays, you can do the following:

- In continuous time, generate approximate-free time and frequency simulations, since delays are no longer replaced by a Padé approximation. In continuous time, this allows for more accurate analysis of systems with long delays.
- In discrete time, you can keep delays separate from other system dynamics. Delays are not replaced with poles at $z=0$, which boosts efficiency of time and frequency simulations for discrete-time systems with long delays.
- Use most Control System Toolbox functions.
- Test advanced control strategies for delayed systems. For example, you can implement and test an accurate model of a Smith predictor. See the Smith predictor demo.

See “Inside Time Delay Models” on page 1-79 for more information about how internal delay are modeled.

Why Internal Delays Are Necessary

Why are input, output, and I/O delays not enough to model systems? Consider the simple feedback loop with a 2 s. delay:

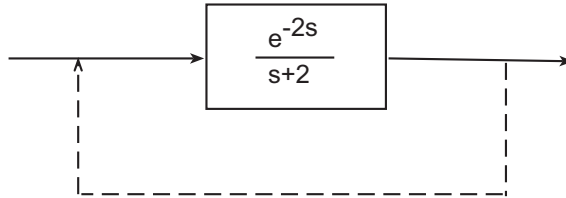

The closed-loop transfer function is

$$\frac{e^{-2s}}{s + 2 + e^{-2s}}$$

While the delay term in the numerator can be represented as an output delay, the delay term in the denominator cannot. In order to model the effect of the delay on the feedback loop, an additional property is needed to keep track of internal coupling between delays and ordinary dynamics.

Building Models with Internal Delays

Typically, state-space models with internal delays are not created by specifying A, B, C, and D matrices together with a set of internal delays. Rather, build such models by connecting simpler LTI models (some with I/O delays) in series, parallel, or feedback. There is no limitation on how many delays are involved and how the LTI models are connected. For example, consider the following control loop, where the plant is modeled as first-order plus dead time.

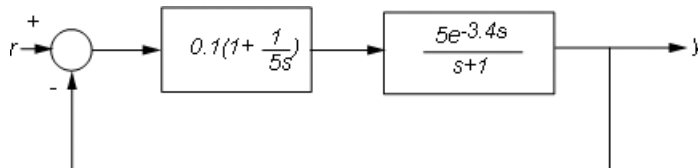

Using the state-space representation, you can derive model T for the closed-loop response from r to y and simulate it by

```
P = ss(5*exp(-3.4*s)/(s+1));
C = 0.1 * (1 + 1/(5*s));
T = feedback(P*C,1)
```

```
a =
      x1      x2
x1   -1.5    0.32
x2  -0.3125   0
```

```
b =
      u1
x1   0.2
x2  0.125
```

```
c =
      x1      x2
y1  2.5    0
```

```
d =
      u1
y1   0
```

(a,b,c,d values when setting all internal delays to zero)

Internal delays: 3.4

Review the following considerations when you work with models with internal delays:

- The software converts model from TF representation to SS.
- The software fully supports feedback loops. You can wrap a feedback loop around any system with delays.
- When displaying the A, B, C, and D matrices, the software sets all delays to zero (creating a zero-order Padé approximation).

For some systems, setting delays to zero creates singular algebraic loops, which result in either improper or ill-defined, zero-delay approximations.

For these systems, typing the command

- `sys` returns only sizes for the matrices of a system named `sys`.
- `sys.a` produces an error.

The limited display and the error do not imply a problem with the model `sys` itself.

You can create arbitrary linear systems with delays using combinations of state-space models and interconnection functions. Build complex models incrementally by interconnecting smaller models. You can decompose complex diagrams unless you have lumped delays (as in integral equations). After you create a system with internal delays, you can view and change the delays' values using dot notation. For example:

```
sys_delay.Internaldelay
```

```
ans =
```

```
1.5000
```

You cannot modify the number of internal delays because they are structural properties of the model. You can, however, set the delays to 0 or change their values.

Analyzing Systems With Delays

You can use the usual analysis commands (`step`, `bode`, `margin`, ...) to analyze systems with delays. The software makes no approximations when performing such analysis.

For example, use this code to see the closed-loop step response of `T`.

```
step(T)
grid, title('Closed-loop step response')
```

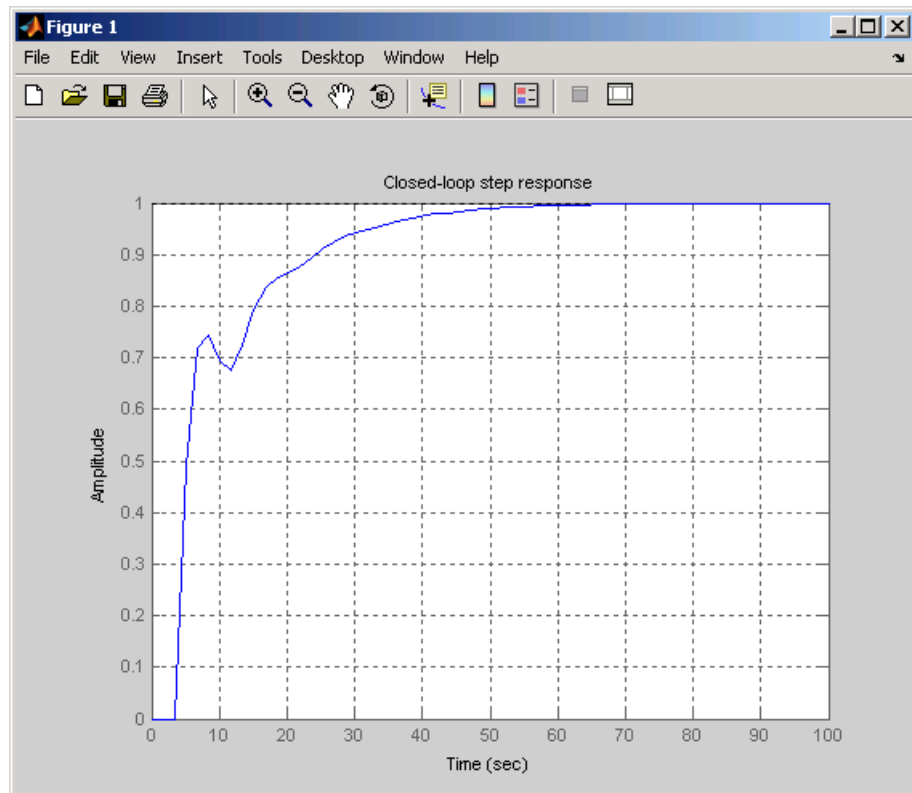

For more complicated interconnections, you can name the input and output signals of each block and use `connect` to automatically take care of the wiring. Suppose, for example, that you want to add feedforward to the control loop of the previous model.

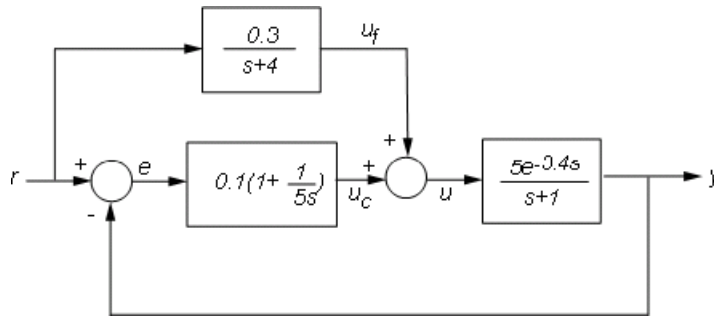

You can derive the corresponding closed-loop model T by

```
F = 0.3/(s+4);
P.InputName = 'u'; P.OutputName = 'y';
C.InputName = 'e'; C.OutputName = 'uc';
F.InputName = 'r'; F.OutputName = 'uf';
Sum1 = sumblk('e','r','y','+-'); % e = r-y
Sum2 = sumblk('u','uf','uc','++'); % u = uf+uc
Tff = connect(P,C,F,Sum1,Sum2,'r','y');
```

and compare its response with the feedback only design.

```
step(T,'b',Tff,'r')
legend('No feedforward','Feedforward')
grid
title('Closed-loop step response with and without feedforward')
```

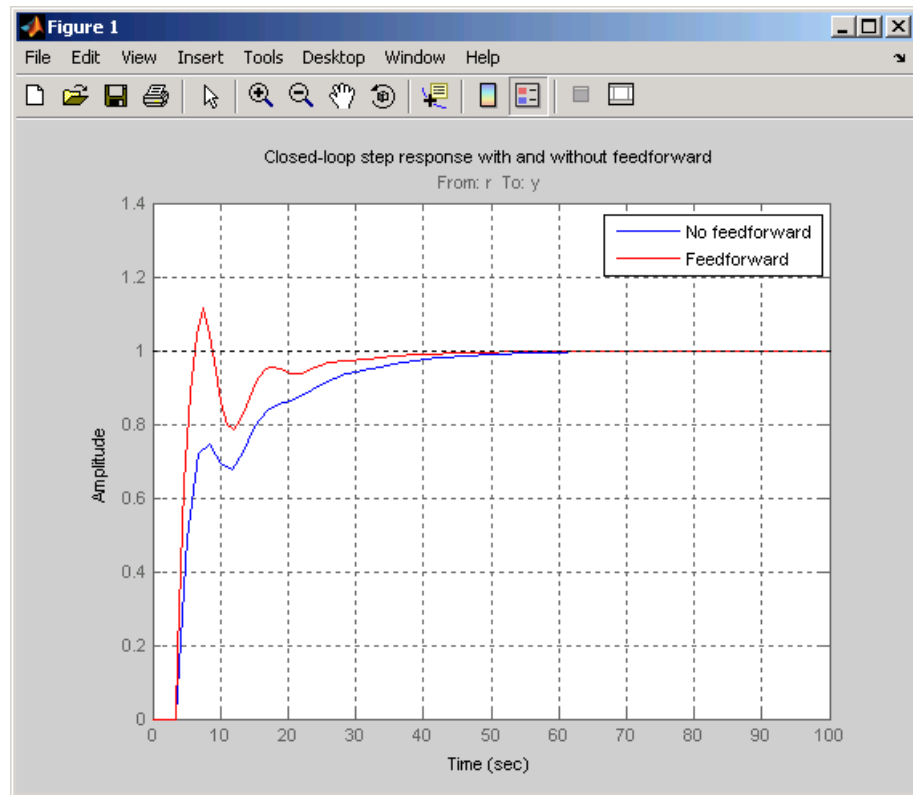

Considerations to Keep in Mind when Analyzing Systems with Internal Time Delays

The time and frequency responses of delay systems can look odd and suspicious to those only familiar with delay-free LTI analysis. Time responses can behave chaotically, Bode plots can exhibit gain oscillations, etc. These are not software or numerical quirks but real features of such systems. Below are a few illustrations of these phenomena.

Gain ripple:

```
s=tf('s');
G = exp(-5*s)/(s+1);
T = feedback(ss(G),.5);
```

bodemag(T)

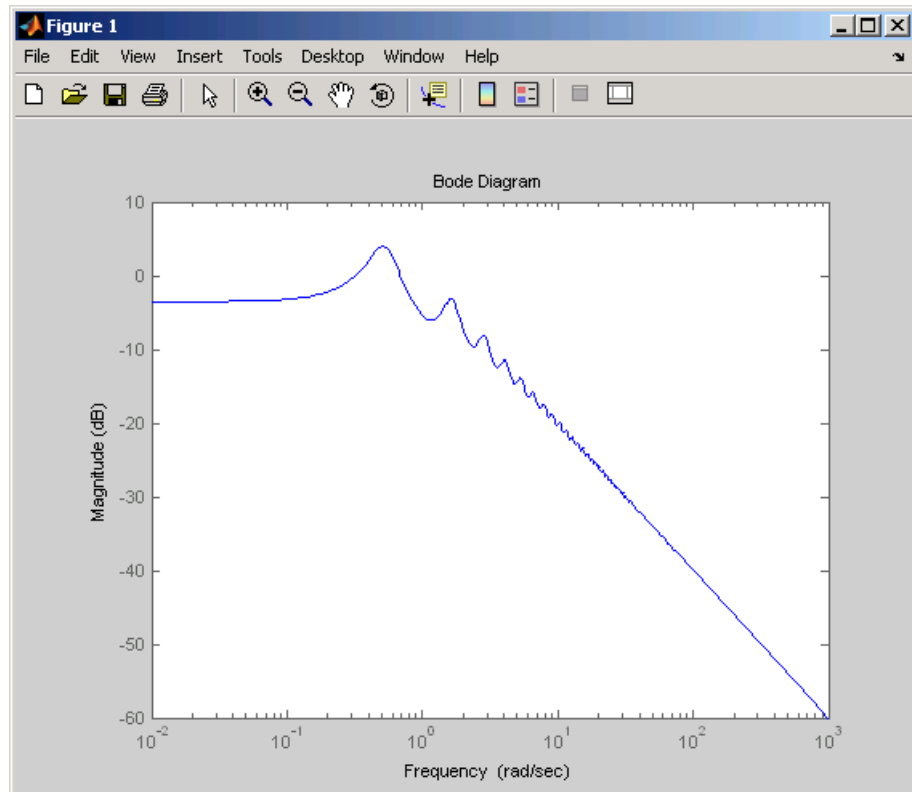

Gain oscillations:

```
G = ss(1) + 0.5 * exp(-3*s);  
bodemag(G)
```

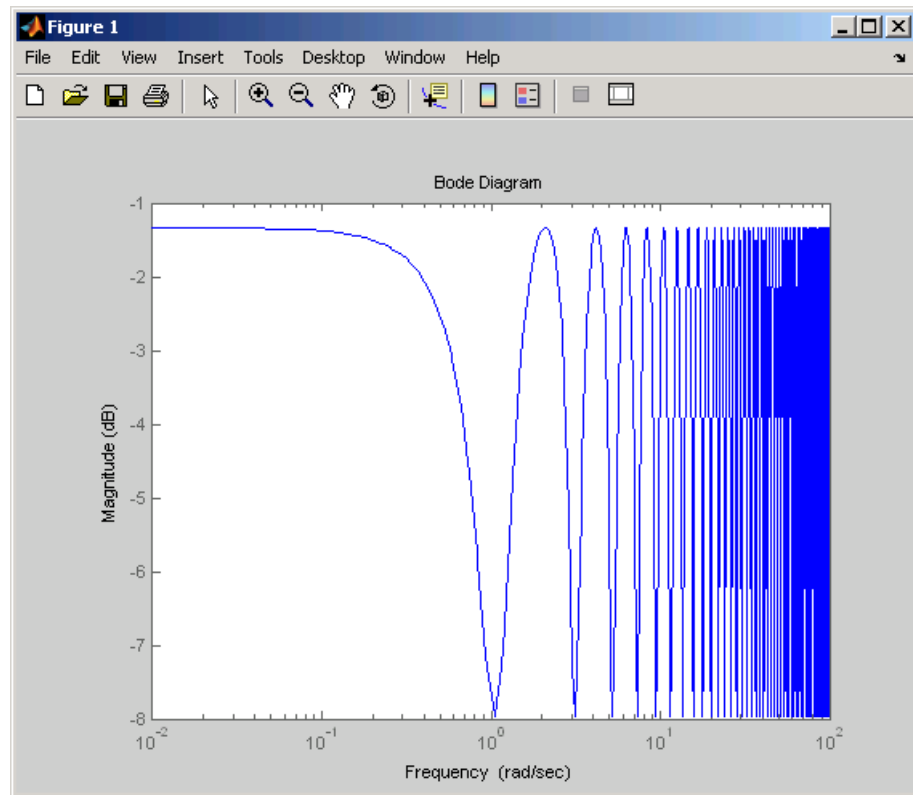
**Jagged step response:**

```
G = exp(-s) * (0.8*s^2+s+2)/(s^2+s);  
T = feedback(ss(G),1);  
step(T)
```

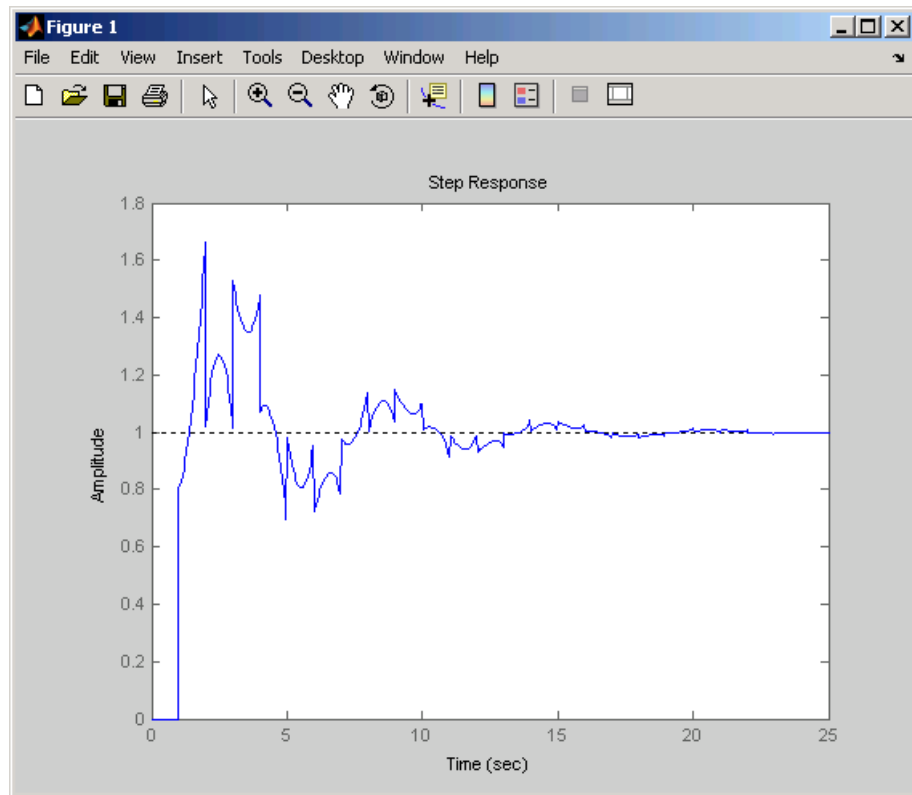

Note the rearrivals (echoes) of the initial step function.

Chaotic response:

```
G = ss(1/(s+1)) + exp(-4*s);
```

```
T = feedback(1,G);
```

```
step(T)
```

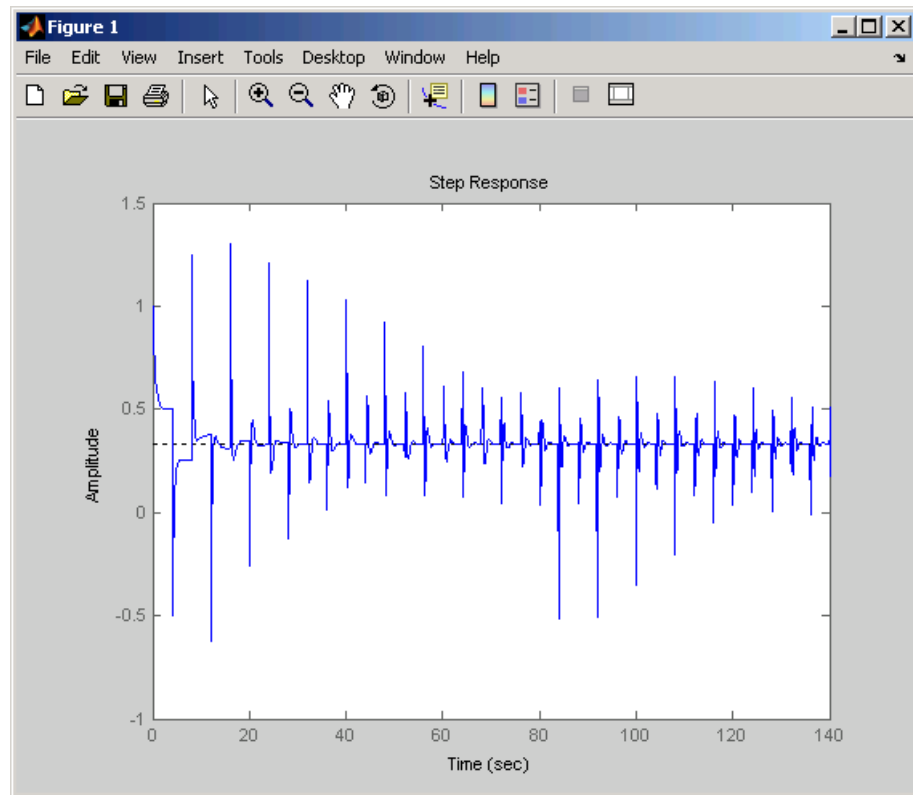

You can use Control System Toolbox tools to model and analyze these and other strange-appearing artifacts of internal delays.

Eliminating Time Delays: Padé Approximation

Most control design algorithms cannot handle time delays directly. For example, root locus, LQG, pole placement, etc., will not work properly if time delays are present. A common technique is to replace delays by their Padé approximations (all-pass filters). But because this approximation is valid only at low frequencies, it is important to compare the true and approximate responses to choose the right approximation order and check the approximation validity. Use the `pade` command to compute Padé approximations of LTI models with delays. For example, consider a system with a PI controller:

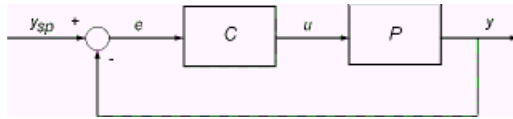

Use this code to implement the system:

```
s = tf('s');  
P = exp(-2.6*s)*(s+3)/(s^2+0.3*s+1);  
C = 0.06 * (1 + 1/s);  
T = feedback(ss(P*C),1);
```

For the PI controller, you can compare the exact closed-loop response T with the response obtained for a first-order Padé approximation of the delay:

```
T1 = pade(T,1);  
step(T,'b--',T1,'r',100)  
grid, legend('Exact','First-Order Pade')
```

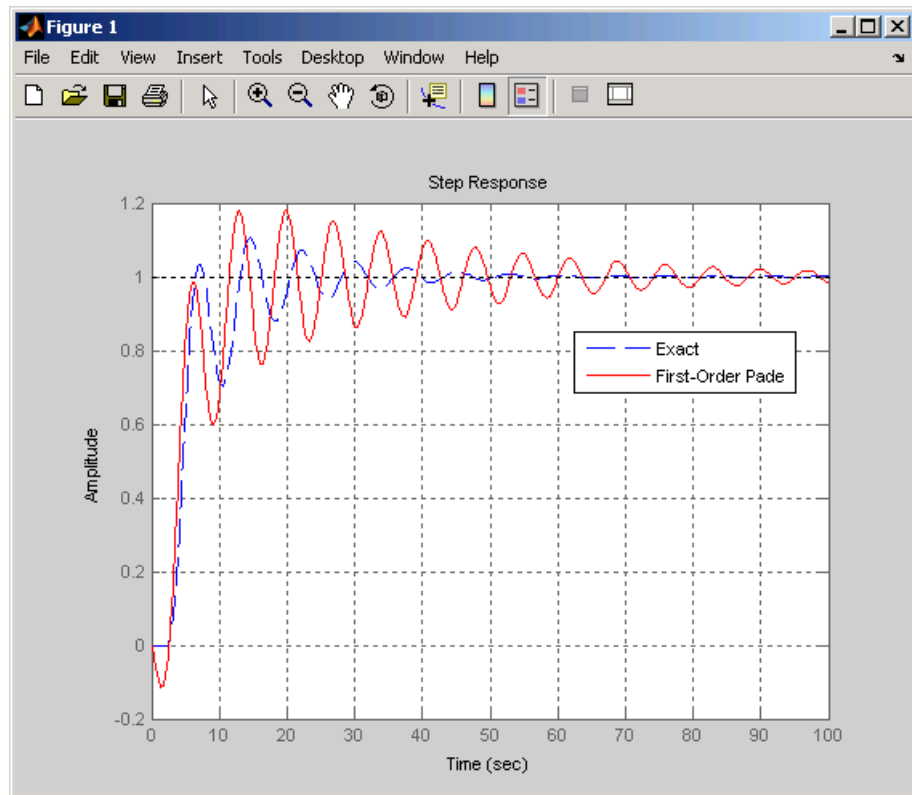
The approximation error is large. To get a better approximation, try a second-order Padé approximation of the delay:

```
T2 = pade(T,2);  
step(T,'b--',T2,'r',100)  
grid, legend('Exact','Second-Order Padé')
```

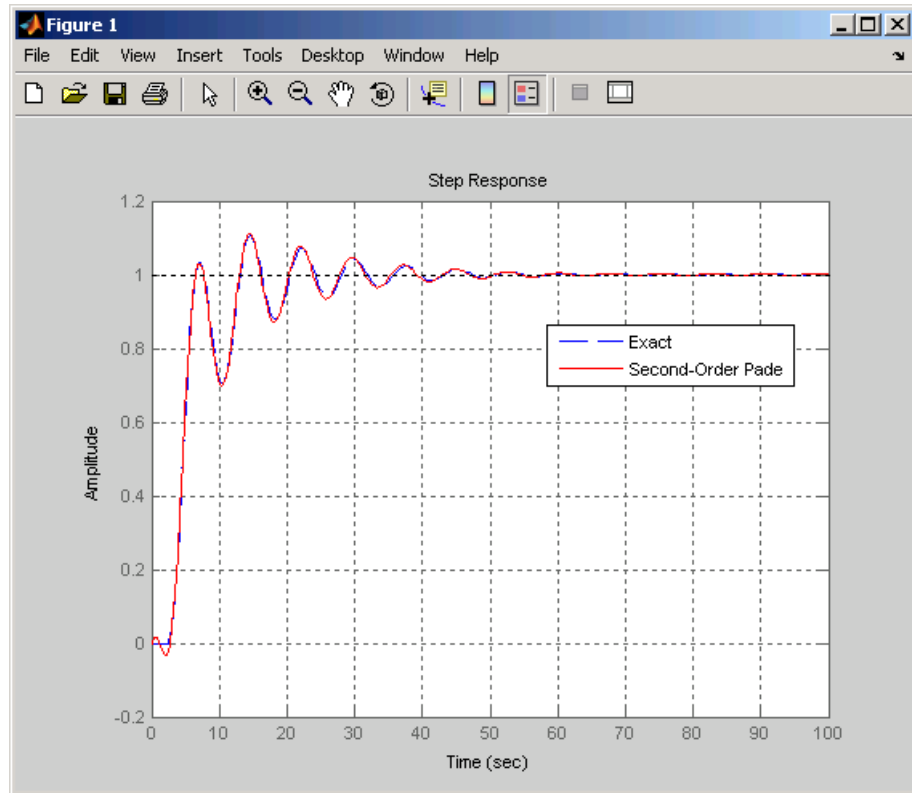

The responses now match closely except for the nonminimum phase artifact (“wrong way” effect) introduced by the Padé approximation.

Sensitivity Analysis

Delays are rarely known accurately, so it is often important to understand how sensitive a control system is to the delay value. Such sensitivity analysis is easily performed using LTI arrays and the `InternalDelay` property. For example, consider this notched PI control system developed in “PI Control Loop with Dead Time” from the Analyzing Control Systems with Delays demo.

```
% Create a 3rd-order plant with a PI controller and notch filter.
s = tf('s');
P = exp(-2.6*s)*(s+3)/(s^2+0.3*s+1);
```

```
C = 0.06 * (1 + 1/s);
T = feedback(ss(P*C),1)
notch = tf([1 0.2 1],[1 .8 1]);
C = 0.05 * (1 + 1/s);
Tnotch = feedback(ss(P*C*notch),1);
```

Create five models with delay values ranging from 2.0 to 3.0:

```
tau = linspace(2,3,5);           % 5 delay values
Tsens = repsys(Tnotch,[1 1 5]);  % 5 copies of Tnotch
                                   % for j=1:5
Tsens(:, :, j).InternalDelay = tau(j); % jth delay value
                                   % -> jth model end

% Use step to create an envelope plot.
step(Tsens)
grid
title('Closed-loop response for 5 delay values between 2.0 and 3.0')
```

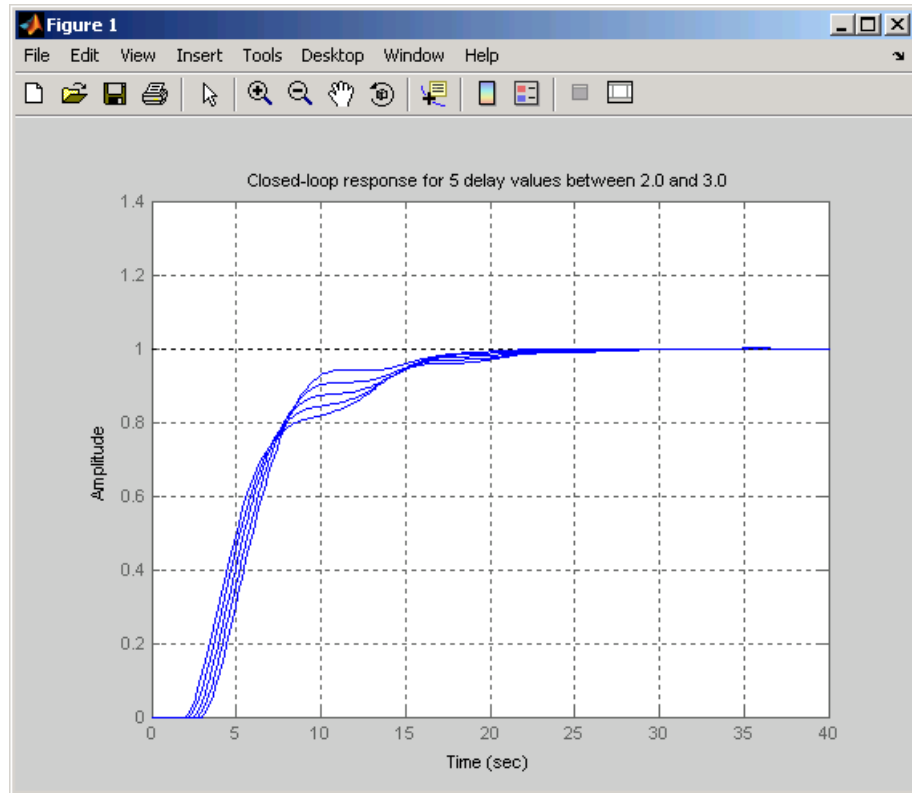

This plot shows that uncertainty on the delay value has little effect on closed-loop characteristics. Note that while you can change the values of internal delays, you cannot change how many there are because this is part of the model structure. To eliminate some internal delays, set their value to 0 or use `pade` with order zero:

```
Tnotch0 = Tnotch;
Tnotch0.InternalDelay = 0;
bode(Tnotch, 'b', Tnotch0, 'r', {1e-2, 3})
grid, legend('Delay = 2.6', 'No delay', 'Location', 'SouthWest')
```

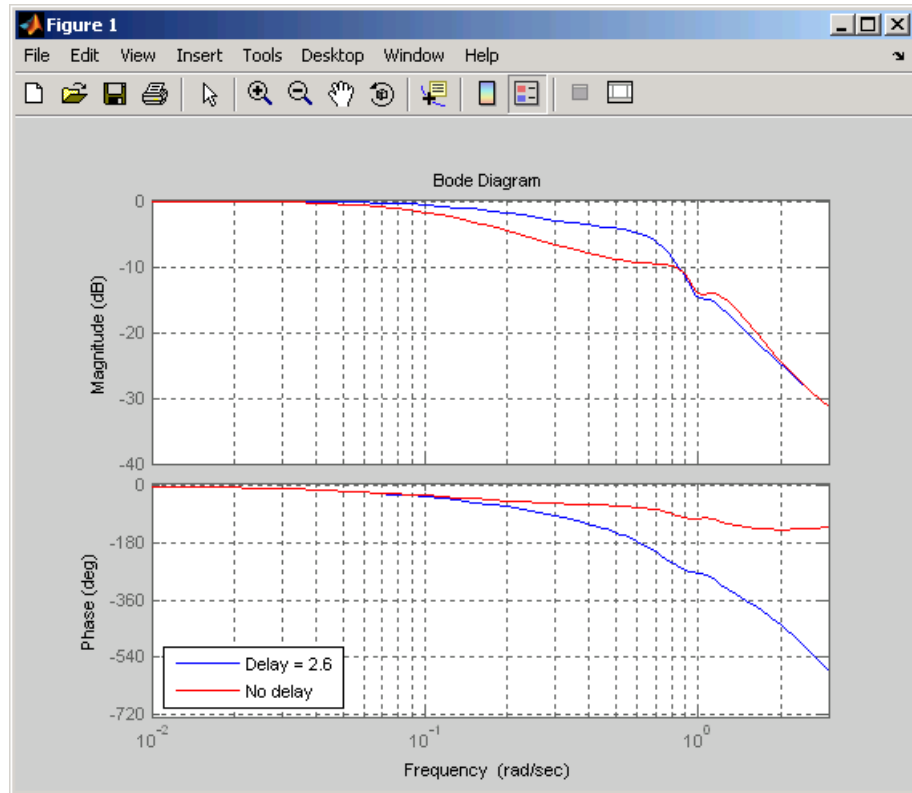

Specifying Delays in Discrete-Time Models

Discrete-time delays are handled in a similar way, but have some minor differences:

- Discrete-time delays are always integer multiples of the sampling period.
- Discrete-time delays are equivalent to poles at $z=0$, so it is always possible to absorb delays into the model dynamics (see `delay2z`). Keeping delays separate is better for performance, especially for systems with long delays compared to the sampling period.

For example, to specify the first-order model

$$H(z) = z^{-25} \frac{2}{z - 0.25}$$

with sampling period $T_s=0.1$, and a delay of 25 sample periods, use

```
H = tf(2,[1 -0.95],0.1,'inputdelay',25)
step(H)
```

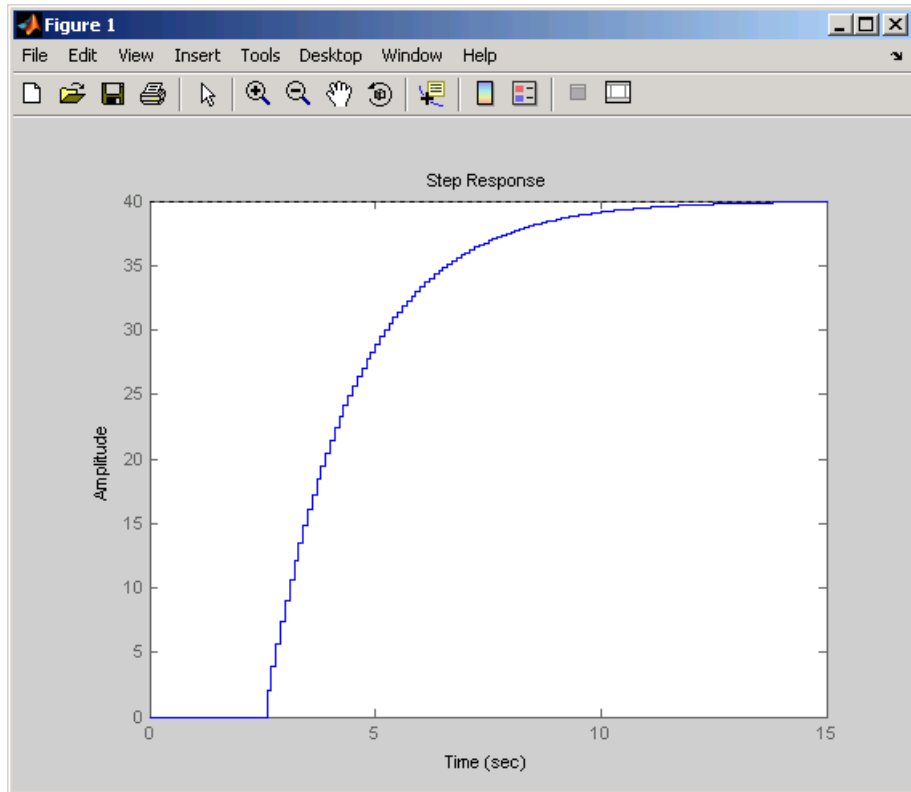

The equivalent state-space representation is:

```
H = ss(H)
a =
    x1
```

```
x1  0.95
```

```
b =
```

```
      u1
x1    2
```

```
c =
```

```
      x1
y1    1
```

```
d =
```

```
      u1
y1    0
```

Input delays (listed by channel): 25

Sampling time: 0.1
Discrete-time model.

Example: Discrete-Time Model with Delayed Feedback

Next, consider the feedback loop below where g is a pure gain.

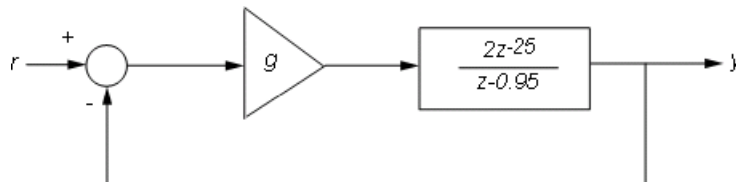

To compute the closed-loop response for $g=0.01$, type:

```
g = .01;
T = feedback(g*H,1)
step(T)
```

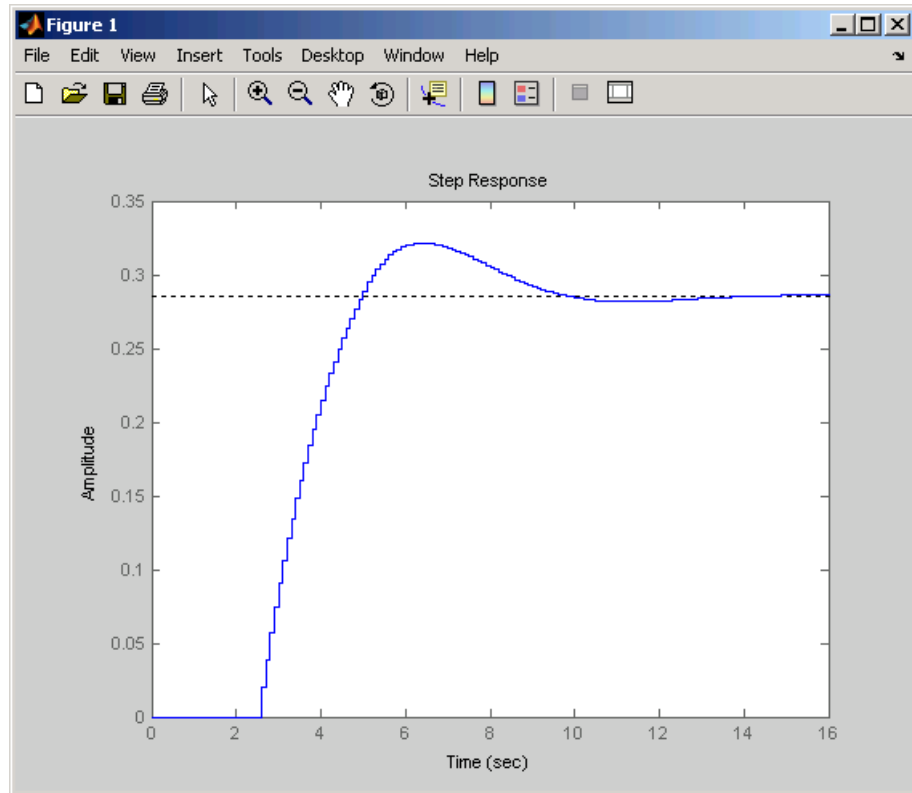

T is still a first-order model with an internal delay of 25 samples. For comparison, map all delays to poles at $z=0$ using `delay2z`:

```
T1 = delay2z(T);
order(T1)
ans =
```

```
26
```

The resulting model has 26 states and is therefore less efficient to simulate. As expected, however, the step responses of T and $T1$ match exactly:

```
step(T, 'b', T1, 'r--')
legend('T', 'T1')
```

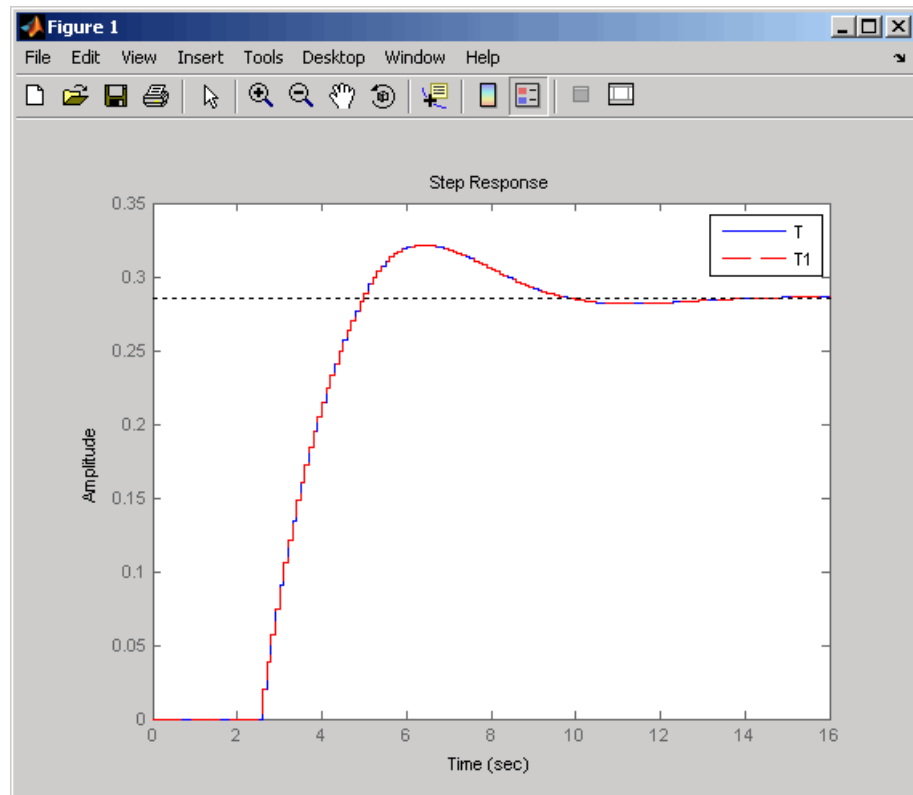
In general, it is recommended to keep delays separate, except when analyzing the closed-loop dynamics of models with internal delays. For example:

```
rlocus(H)
```

```
axis([-1.25 1.25 -1.25 1.25])
```

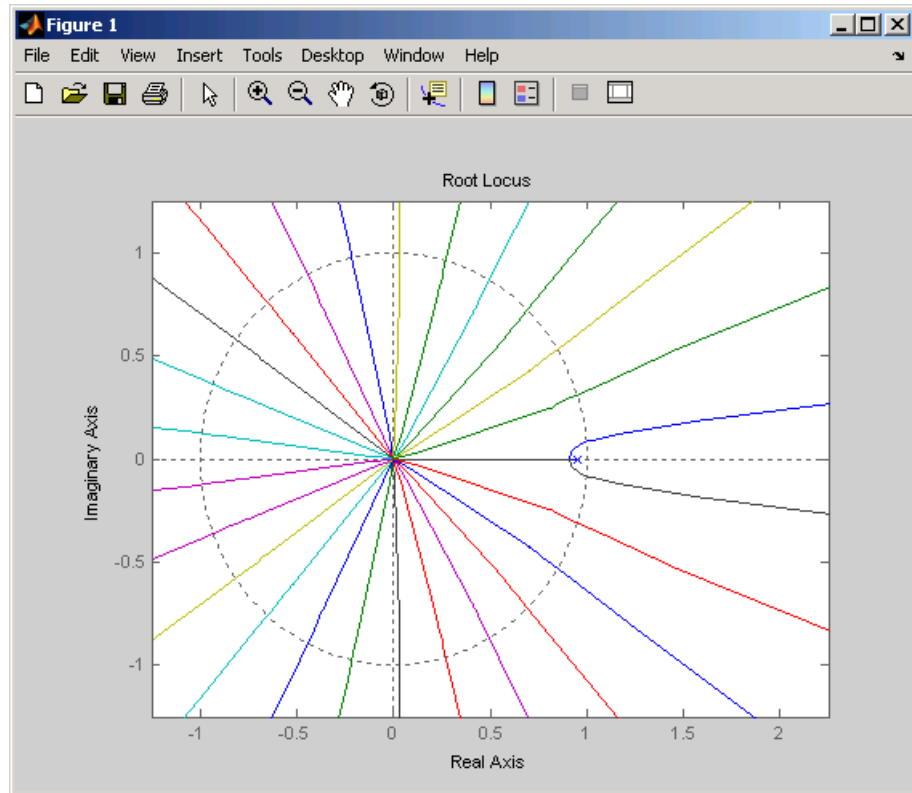

Discretization

You can use `c2d` to discretize continuous-time delay systems. Available methods include zero-order hold (ZOH), first-order hold (FOH), and Tustin. For models with internal delays, the ZOH discretization is not always exact, i.e., the continuous and discretized step responses may not match:

```
s = tf('s');
P = exp(-2.6*s)*(s+3)/(s^2+0.3*s+1);
C = 0.06 * (1 + 1/s);
T = feedback(ss(P*C),1);
Td = c2d(T,1); step(T,'b',Td,'r')
grid, legend('Continuous','ZOH Discretization')
```

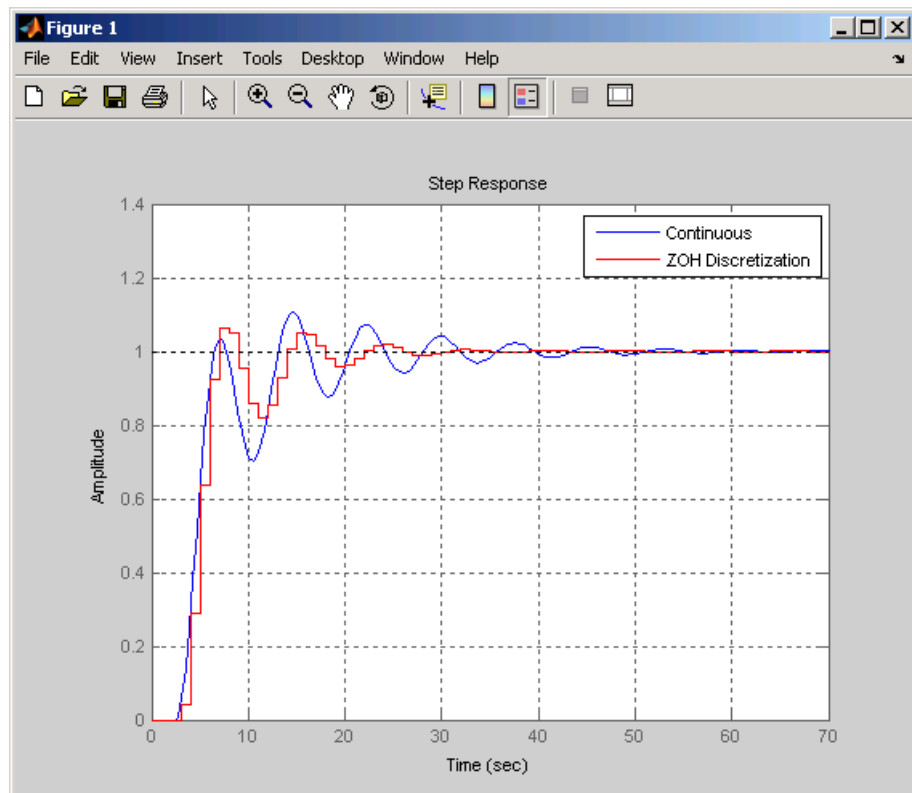

To correct such discretization gaps, reduce the sampling period until the continuous and discrete responses match closely:

```
Td = c2d(T,0.05); step(T,'b',Td,'r')
grid, legend('Continuous','ZOH Discretization')
```

Warning: Discretization is only approximate due to internal delays. Use faster sampling rate if discretization error is large.

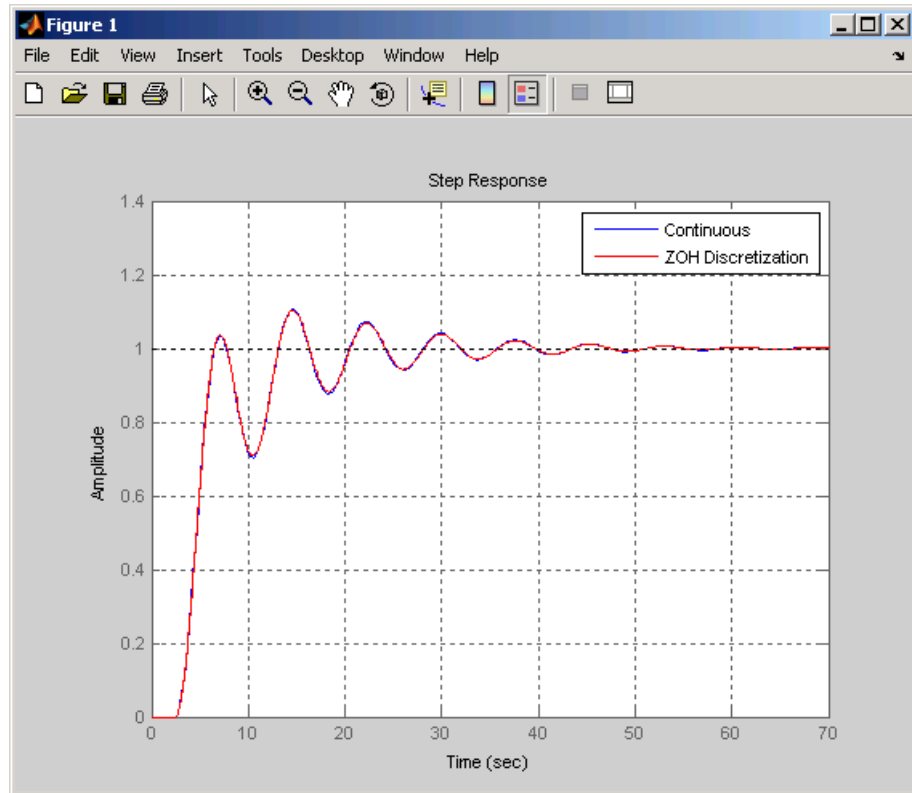

Note that internal delays remain internal in the discretized model and do not inflate the model order:

```
order(Td)
ans =
```

```
3
```

Functions That Support Internal Time Delays

The following commands support internal delays for both continuous- and discrete-time systems:

- All interconnection functions

- Time domain response functions—except for `impulse` and `initial`
- Frequency domain functions—except for `norm`

Limitations on Functions that Support Internal Time Delays

The following commands support internal delays for both continuous- and discrete-time systems and have certain limitations:

- `allmargin`, `margin`—Uses interpolation, therefore these commands are only as precise as the fineness of the specified grid.
- `pole`, `zero`—Returns poles and zeros of the system with all delays set to zero.
- `ssdata`, `get`—If an SS model has internal delays, these commands return the A, B, C, and D matrices of the system with all internal delays set to zero. Augmented state-space equations keep track of which internal delays enter the model.

Functions That Do Not Support Internal Time Delays

The following commands do not do not support time delays:

- System dynamics—`norm` and `lti/isstable`
- Time-domain analysis—`initial`, `initialplot`, `impulse`, and `impulseplot`
- Model simplification—`balreal`, `balred`, `minreal`, `modred`, and `andsminreal`
- Conversions—to ZPK and TF representations
- Compensator design—`rlocus`, `lqg`, `lqry`, `lqrd`, `kalman`, `kalmd`, `lqgreg`, `lqgtrack`, `lqi`, and `augstate`

In addition, the SISO Design Tool does not accept systems with internal delays.

Inside Time Delay Models

State-space objects use generalized state-space equations to keep track of internal delays. Conceptually, such models consist of two interconnected parts:

- An ordinary state-space model $H(s)$ with an augmented I/O set
- A bank of internal delays.

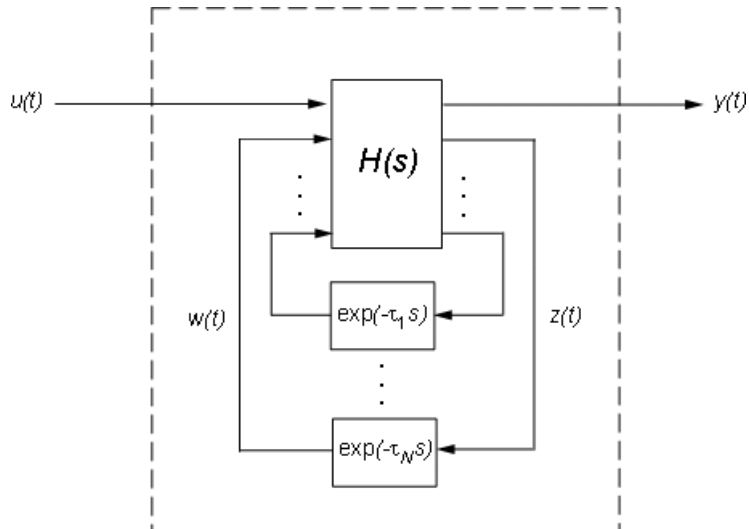

The corresponding state-space equations are:

$$\begin{aligned} \dot{x} &= Ax(t) + B_1 u(t) + B_2 w(t) \\ y(t) &= C_1 x(t) + D_{11} u(t) + D_{12} w(t) \\ z(t) &= C_2 x(t) + D_{21} u(t) + D_{22} w(t) \\ w_j(t) &= z(t - \tau_j), \quad j = 1, \dots, N \end{aligned}$$

You need not bother with this internal representation to use the tools. If, however, you want to extract H or the matrices A, B_1, B_2, \dots , you can use `getDelayModel`. For the example:

```
P = 5*exp(-3.4*s)/(s+1);
C = 0.1 * (1 + 1/(5*s));
T = feedback(ss(P*C),1);
[H,tau] = getDelayModel(T,'lft'); size(H)
```

Note that H is a two-input, two-output model whereas T is SISO. The inverse operation (combining H and τ to construct T) is performed by `setDelayModel`.

See [3, 4] for details.

Simulink Block for LTI Systems

You can incorporate LTI objects into Simulink® diagrams using the LTI System block shown below.

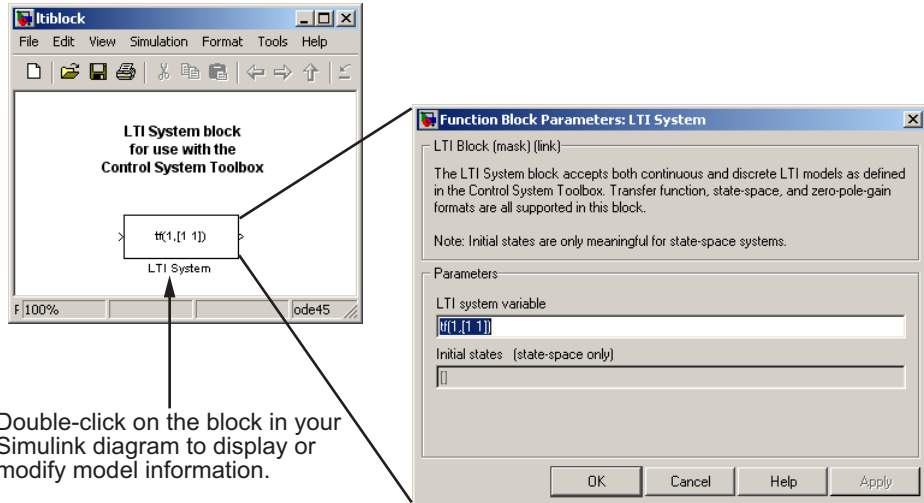

Double-click on the block in your Simulink diagram to display or modify model information.

The LTI System block can be accessed either by typing

```
ltiblock
```

at the MATLAB prompt or by selecting **Control System Toolbox** from the **Blocksets and Toolboxes** section of the main Simulink library.

The LTI System block consists of the dialog box shown on the right in the figure above. In the editable text box labeled **LTI system variable**, enter either the variable name of an LTI object located in the MATLAB workspace (for example, `sys`) or a MATLAB expression that evaluates to an LTI object (for example, `tf(1,[1 1])`). The LTI System block accepts both continuous and discrete LTI objects in either transfer function, zero-pole-gain, or state-space form. All types of delays are supported in the LTI block. Simulink converts the model to its state-space equivalent prior to initializing the simulation.

Use the editable text box labeled **Initial states** to enter an initial state vector for state-space models. The concept of "initial state" is not well-defined for transfer functions or zero-pole-gain models, as it depends on the choice of state coordinates used by the realization algorithm. As a result, you cannot enter nonzero initial states when you supply TF or ZPK models to LTI blocks in a Simulink diagram.

References

- [1] Dorf, R.C. and R.H. Bishop, *Modern Control Systems*, Addison-Wesley, Menlo Park, CA, 1998.
- [2] Wood, R.K. and M.W. Berry, "Terminal Composition Control of a Binary Distillation Column," *Chemical Engineering Science*, 28 (1973), pp. 1707-1717.
- [3] P. Gahinet and L.F. Shampine, "Software for Modeling and Analysis of Linear Systems with Delays," *Proc. American Control Conf.*, Boston, 2004, pp. 5600-5605
- [4] L.F. Shampine and P. Gahinet, Delay-differential-algebraic Equations in Control Theory, *Applied Numerical Mathematics*, 56 (2006), pp. 574-588

Operations on LTI Models

- “Overview” on page 2-2
- “Precedence and Property Inheritance” on page 2-3
- “Extracting and Modifying Subsystems” on page 2-5
- “Arithmetic Operations on LTI Models” on page 2-12
- “Model Interconnection Functions” on page 2-17
- “Continuous/Discrete Conversions of LTI Models” on page 2-21
- “Resampling of Discrete-Time Models” on page 2-31
- “References” on page 2-35

Overview

You can perform basic matrix operations such as addition, multiplication, or concatenation on LTI models. Such operations are "overloaded," which means that they use the same syntax as they do for matrices, but are adapted to apply to LTI objects. These overloaded operations and their interpretation in this context are discussed in this chapter. You can read about discretization methods in this chapter as well.

These operations can be applied to LTI models of different types. As a result, before discussing operations on LTI models, we discuss model type precedence and how LTI model properties are inherited when models are combined using these operations. To read about how you can apply these operations to arrays of LTI models, see "Operations on LTI Arrays" on page 4-27. To read about functions for analyzing LTI models, see Chapter 3, "Model Analysis Tools".

Precedence and Property Inheritance

You can apply operations to LTI models of different types. The resulting type is then determined by the rules discussed in “Precedence Rules” on page 1-8. For example, if `sys1` is a transfer function and `sys2` is a state-space model, then the result of their addition

$$\text{sys} = \text{sys1} + \text{sys2}$$

is a state-space model, since state-space models have precedence over transfer function models.

To supersede the precedence rules and force the result of an operation to be a given type, for example, a transfer function (TF), you can either

- Convert all operands to TF *before* performing the operation
- Convert the result to TF *after* performing the operation

Suppose, in the above example, you want to compute the transfer function of `sys`. You can either use *a priori* conversion of the second operand

$$\text{sys} = \text{sys1} + \text{tf}(\text{sys2});$$

or *a posteriori* conversion of the result

$$\text{sys} = \text{tf}(\text{sys1} + \text{sys2})$$

Note These alternatives are not equivalent numerically; computations are carried out on transfer functions in the first case, and on state-space models in the second case.

Another issue is property inheritance, that is, how the operand property values are passed on to the result of the operation. While inheritance is partly operation-dependent, some general rules are summarized below:

- In operations combining discrete-time LTI models, all models must have identical or unspecified (`sys.Ts = -1`) sample times. Models resulting from such operations inherit the specified sample time, if there is one.

- Most operations ignore the `Notes` and `Userdata` properties.
- In general, when two LTI models `sys1` and `sys2` are combined using operations such as `+`, `*`, `[,]`, `[:,]`, `append`, and `feedback`, the resulting model inherits its I/O names and I/O groups from `sys1` and `sys2`. However, conflicting I/O names or I/O groups are not inherited. For example, the `InputName` property for `sys1 + sys2` is left unspecified if `sys1` and `sys2` have different `InputName` property values.
- A model resulting from operations on TF or ZPK models inherits its `Variable` property value from the operands. Conflicts are resolved according the following rules:
 - For continuous-time models, `'p'` has precedence over `'s'`.
 - For discrete-time models, `'z^-1'` has precedence over `'q'` and `'z'`, while `'q'` has precedence over `'z'`.

Extracting and Modifying Subsystems

In this section...

“What is a Subsystem?” on page 2-5

“Basic Subsystem Concepts” on page 2-5

“Referencing FRD Models Through Frequencies” on page 2-8

“Referencing Channels by Name” on page 2-9

“Resizing LTI Systems” on page 2-10

What is a Subsystem?

Subsystems relate subsets of the inputs and outputs of a system. The transfer matrix of a subsystem is a submatrix of the system transfer matrix.

Basic Subsystem Concepts

For example, if `sys` is a system with two inputs, three outputs, and I/O relation

$$y = Hu$$

then $H(3,1)$ gives the relation between the first input and third output.

$$y_3 = H(3,1) u_1$$

Accordingly, use matrix-like subindexing to extract this subsystem.

$$\text{SubSys} = \text{sys}(3,1)$$

The resulting subsystem `SubSys` is an LTI model of the same type as `sys`, with its sample time, time delay, I/O name, and I/O group property values inherited from `sys`.

For example, if `sys` has an input group named `controls` consisting of channels one, two, and three, then `SubSys` also has an input group named `controls` with the first channel of `SubSys` assigned to it.

If `sys` is a state-space model with matrices `a`, `b`, `c`, `d`, the subsystem `sys(3,1)` is a state-space model with data `a`, `b(:,1)`, `c(3,:)`, `d(3,1)`. Note the following rules when extracting subsystems:

- In the expression `sys(3,1)`, the first index selects the output channel while the second index selects the input channel.
- When extracting a subsystem from a given state-space model, the resulting state-space model may not be minimal. Use the command `smnreal` to eliminate unnecessary states in the subsystem.

You can use similar syntax to modify the LTI model `sys`. For example,

```
sys(3,1) = NewSubSys
```

redefines the I/O relation between the first input and third output, provided `NewSubSys` is a SISO LTI model.

Rules for Modifying LTI Model Subsystems

The following rules apply when modifying LTI model subsystems:

- `sys`, the LTI model that has had a portion reassigned, retains its original model type (TF, ZPK, SS, or FRD) regardless of the model type of `NewSubSys`.
- Subsystem assignment does not reassign any I/O names or I/O group names of `NewSubSys` that are already assigned to `NewSubSys`.
- Reassigning parts of a MIMO state-space model generally increases its order.
- If `NewSubSys` is an FRD model, then `sys` must also be an FRD model. Furthermore, their frequencies must match.

Other standard matrix subindexing extends to LTI objects as well. For example,

```
sys(3,1:2)
```

extracts the subsystem mapping the first two inputs to the third output.

```
sys(:,1)
```

selects the first input and all outputs, and

```
sys([1 3],:)
```

extracts a subsystem with the same inputs, but only the first and third outputs.

For example, consider the two-input/two-output transfer function

$$T(s) = \begin{bmatrix} \frac{1}{s+0.1} & 0 \\ \frac{s-1}{s^2+2s+2} & \frac{1}{s} \end{bmatrix}$$

To extract the transfer function $T_{11}(s)$ from the first input to the first output, type

```
T(1,1)
```

```
Transfer function:
```

```
  1
-----
s + 0.1
```

Next reassign $T_{11}(s)$ to $1/(s+0.5)$ and modify the second input channel of T by typing

```
T(1,1) = tf(1,[1 0.5]);
T(:,2) = [ 1 ; tf(0.4,[1 0]) ]
```

```
Transfer function from input 1 to output...
```

```
  1
-----
#1:  s + 0.5

      s - 1
-----
#2:  s^2 + 2 s + 2
```

Transfer function from input 2 to output...

```
#1:  1
      0.4
#2:  ---
      s
```

Referencing FRD Models Through Frequencies

You can extract subsystems from FRD models, as you do with other LTI model types, by indexing into input and output (I/O) dimensions. You can also extract subsystems by indexing into the frequencies of an FRD model.

To index into the frequencies of an FRD model, use the string *'Frequency'* (or any abbreviation, such as, *'freq'*, as long as it does not conflict with existing I/O channel or group names) as a keyword. There are two ways you can specify FRD models using frequencies:

- Using integers to index into the frequency vector of the FRD model
- Using a Boolean (logical) expression to specify desired frequency points in an FRD model

For example, if `sys` is an FRD model with five frequencies, (e.g., `sys.Frequency=[1 1.1 1.2 1.3 1.4]`), then you can create a new FRD model `sys2` by indexing into the frequencies of `sys` as follows.

```
sys2 = sys('frequency', 2:3);
sys2.Frequency
```

```
ans =
    1.1000
    1.2000
```

displays the second and third entries in the frequency vector.

Similarly, you can use logical indexing into the frequencies.

```
sys2 = sys('frequency', sys.Frequency >1.0 & sys.Frequency <1.15);
sys2.freq
```

```
ans =  
    1.1000
```

You can also combine model extraction through frequencies with indexing into the I/O dimensions. For example, if `sys` is an FRD model with two inputs, two outputs, and frequency vector `[2.1 4.2 5.3]`, with `sys.Units` specified in rad/s, then

```
sys2 = sys(1,2,'freq',1)
```

specifies `sys2` as a SISO FRD model, with one frequency data point, 2.1 rad/s.

Referencing Channels by Name

You can also extract subsystems using I/O group or channel names. For example, if `sys` has an input group named `noise`, consisting of channels two, four, and five, then

```
sys(1,'noise')
```

is equivalent to

```
sys(1,[2 4 5])
```

Similarly, if `pressure` is the name assigned to an output channel of the LTI model `sys`, then

```
sys('pressure',1) = tf(1, [1 1])
```

reassigns the subsystem from the first input of `sys` to the output labeled `pressure`.

You can reference a set of channels by input or output name by using a cell array of strings for the names. For example, if `sys` has one output channel named `pressure` and one named `temperature`, then these two output channels can be referenced using

```
sys({'pressure','temperature'})
```

Resizing LTI Systems

Resizing a system consists of adding or deleting inputs and/or outputs. To delete the first two inputs, simply type

```
sys(:,1:2) = []
```

In deletions, at least one of the row/column indexes should be the colon (:) selector.

To perform input/output augmentation, you can proceed by concatenation or subassignment. Given a system `sys` with a single input, you can add a second input using

```
sys = [sys,h];
```

or, equivalently, using

```
sys(:,2) = h;
```

where `h` is any LTI model with one input, and the same number of outputs as `sys`. There is an important difference between these two options: while concatenation obeys the “Precedence Rules” on page 1-8, subsystem assignment does not alter the model type. So, if `sys` and `h` are TF and SS objects, respectively, the first statement produces a state-space model, and the second statement produces a transfer function.

For state-space models, both concatenation and subsystem assignment increase the model order because they assume that `sys` and `h` have independent states. If you intend to keep the same state matrix and only update the input-to-state or state-to-output relations, use `set` instead and modify the corresponding state-space data directly. For example,

```
sys = ss(a,b1,c,d1)
set(sys,'b',[b1 b2],'d',[d1 d2])
```

adds a second input to the state-space model `sys` by appending the *B* and *D* matrices. You should *simultaneously* modify both matrices with a single `set` command. Indeed, the statements

```
sys.b = [b1 b2]
```

and

```
set(sys,'b',[b1 b2])
```

cause an error because they create invalid intermediate models in which the B and D matrices have inconsistent column dimensions.

Arithmetic Operations on LTI Models

In this section...
“Supported Arithmetic Operations” on page 2-12
“Addition and Subtraction” on page 2-12
“Multiplication” on page 2-14
“Inversion and Related Operations” on page 2-15
“Transposition” on page 2-15
“Pertransposition” on page 2-16

Supported Arithmetic Operations

You can apply almost all arithmetic operations to LTI models, including those shown below.

Operation	Description
+	Addition
-	Subtraction
*	Multiplication
. *	Element-by-element multiplication
/	Right matrix divide
\	Left matrix divide
inv	Matrix inversion
'	Pertransposition
. '	Transposition
^	Powers of an LTI model (as in s^2)

Addition and Subtraction

Adding LTI models is equivalent to connecting them in parallel. Specifically, the LTI model

$$\text{sys} = \text{sys1} + \text{sys2}$$

represents the parallel interconnection shown below.

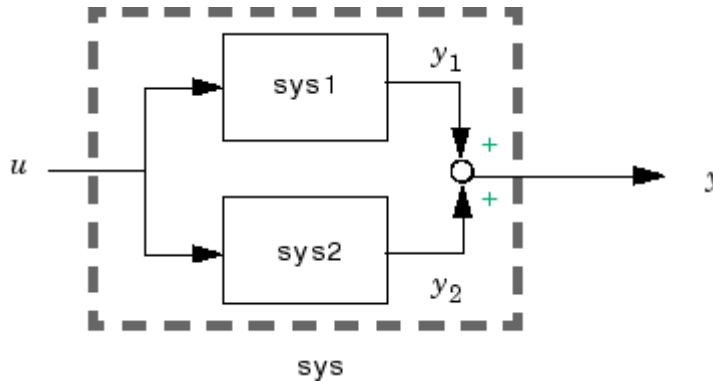

If sys1 and sys2 are two state-space models with data A_1, B_1, C_1, D_1 and A_2, B_2, C_2, D_2 the state-space data associated with $\text{sys1} + \text{sys2}$ is

$$\begin{bmatrix} A_1 & 0 \\ 0 & A_2 \end{bmatrix}, \quad \begin{bmatrix} B_1 \\ B_2 \end{bmatrix}, \quad [C_1 \ C_2], \quad D_1 + D_2$$

Scalar addition is also supported and behaves as follows: if sys1 is MIMO and sys2 is SISO, $\text{sys1} + \text{sys2}$ produces a system with the same dimensions as sys1 whose ij th entry is $\text{sys1}(i, j) + \text{sys2}$.

Similarly, the subtraction of two LTI models

$$\text{sys} = \text{sys1} - \text{sys2}$$

is depicted by the following block diagram.

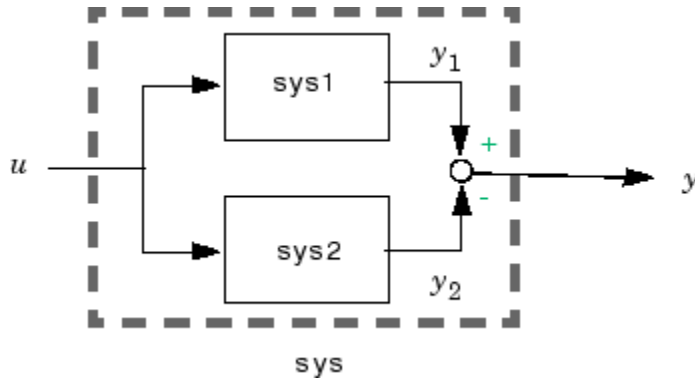

Multiplication

Multiplication of two LTI models connects them in series. Specifically,

$$\text{sys} = \text{sys1} * \text{sys2}$$

returns an LTI model `sys` for the series interconnection shown below.

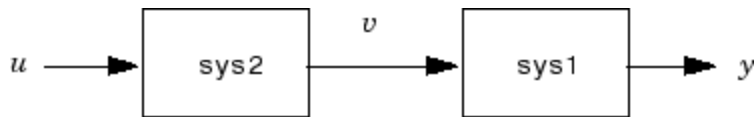

Notice the reverse orders of `sys1` and `sys2` in the multiplication and block diagram. This is consistent with the way transfer matrices are combined in a series connection: if `sys1` and `sys2` have transfer matrices H_1 and H_2 , then

$$y = H_1 v = H_1 (H_2 u) = (H_1 \times H_2) u$$

For state-space models `sys1` and `sys2` with data A_1, B_1, C_1, D_1 and A_2, B_2, C_2, D_2 the state-space data associated with `sys1*sys2` is

$$\begin{bmatrix} A_1 & B_1 C_2 \\ 0 & A_2 \end{bmatrix}, \quad \begin{bmatrix} B_1 D_2 \\ B_2 \end{bmatrix}, \quad [C_1 \quad D_1 C_2], \quad D_1 D_2$$

Finally, if `sys1` is MIMO and `sys2` is SISO, then `sys1*sys2` or `sys2*sys1` is interpreted as an entry-by-entry scalar multiplication and produces a system with the same dimensions as `sys1`, whose ij th entry is `sys1(i, j)*sys2`.

Inversion and Related Operations

Inversion of LTI models amounts to inverting the following input/output relationship.

$$y = H u \quad \rightarrow \quad u = H^{-1}y$$

This operation is defined only for square systems (that is, systems with as many inputs as outputs) and is performed using

`inv(sys)`

The resulting inverse model is of the same type as `sys`. Related operations include:

- Left division `sys1\sys2`, which is equivalent to `inv(sys1)*sys2`
- Right division `sys1/sys2`, which is equivalent to `sys1*inv(sys2)`

For a state-space model `sys` with data A, B, C, D , `inv(sys)` is defined only when D is a square invertible matrix, in which case its state-space data is

$$A - BD^{-1}C, \quad BD^{-1}, \quad -D^{-1}C, \quad D^{-1}$$

Transposition

You can transpose an LTI model `sys` using

`sys.'`

This is a literal operation with the following effect:

- For TF models (with input arguments, `num` and `den`), the cell arrays `num` and `den` are transposed.

- For ZPK models (with input arguments, z , p , and k), the cell arrays, z and p , and the matrix k are transposed.
- For SS models (with model data A, B, C, D), transposition produces the state-space model A^T, C^T, B^T, D^T .
- For FRD models (with complex frequency response matrix `Response`), the matrix of frequency response data at each frequency is transposed.

Pertransposition

For a continuous-time system with transfer function $H(s)$, the *pertransposed* system has the transfer function

$$G(s) = [H(-s)]^T$$

The discrete-time counterpart is

$$G(z) = [H(z^{-1})]^T$$

Pertransposition of an LTI model `sys` is performed using

```
sys'
```

You can use pertransposition to obtain the Hermitian (conjugate) transpose of the frequency response of a given system. The frequency response of the pertranspose of $H(s)$, $G(s) = [H(-s)]^T$, is the Hermitian transpose of the frequency response of $H(s)$: $G(j\omega) = H(j\omega)^H$.

To obtain the Hermitian transpose of the frequency response of a system `sys` over a frequency range specified by the vector `w`, type

```
freqresp(sys', w);
```

Model Interconnection Functions

In this section...
“Supported Interconnection Functions” on page 2-17
“Concatenation of LTI Models” on page 2-18
“Feedback and Other Interconnection Functions” on page 2-19

Supported Interconnection Functions

You can use the Control System Toolbox model interconnection functions to help you build models. With these functions, you can perform I/O concatenation (`[,]`, `[;]`, and `append`), general parallel and series connections (`parallel` and `series`), and feedback connections (`feedback` and `lft`). These functions are useful to model open- and closed-loop systems.

Interconnection Operator	Description
<code>[,]</code>	Concatenates horizontally
<code>[;]</code>	Concatenates vertically
<code>append</code>	Appends models in a block diagonal configuration
<code>augstate</code>	Augments the output by appending states
<code>connect</code>	Forms an SS model from a block diagonal LTI object for an arbitrary interconnection matrix
<code>feedback</code>	Forms the feedback interconnection of two models
<code>lft</code>	Produces the LFT interconnection (Redheffer Star product) of two models
<code>parallel</code>	Forms the generalized parallel connection of two models
<code>series</code>	Forms the generalized series connection of two models

Concatenation of LTI Models

LTI model concatenation is done in a manner similar to the way you concatenate matrices in the MATLAB technical computing environment, using

```
sys = [sys1 , sys2] % horizontal concatenation
sys = [sys1 ; sys2] % vertical concatenation
sys = append(sys1,sys2) % block diagonal appending
```

In I/O terms, horizontal and vertical concatenation have the following block-diagram interpretations (with H_1 and H_2 denoting the transfer matrices of sys1 and sys2).

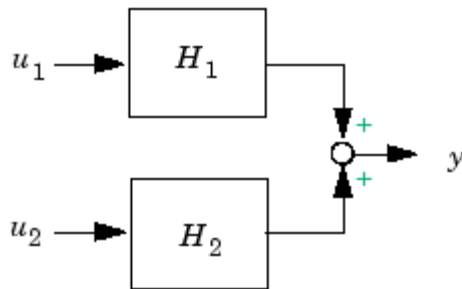

$$y = [H_1, H_2] \begin{bmatrix} u_1 \\ u_2 \end{bmatrix}$$

Horizontal Concatenation

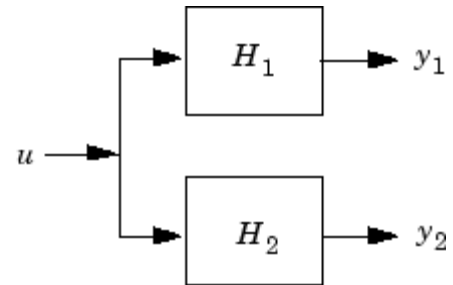

$$\begin{bmatrix} y_1 \\ y_2 \end{bmatrix} = \begin{bmatrix} H_1 \\ H_2 \end{bmatrix} u$$

Vertical Concatenation

You can use concatenation as an easy way to create MIMO transfer functions or zero-pole-gain models. For example,

```
H = [ tf(1,[1 0]) 1 ; 0 tf([1 -1],[1 1]) ]
```

specifies

$$H(s) = \begin{bmatrix} \frac{1}{s} & 1 \\ 0 & \frac{s-1}{s+1} \end{bmatrix}$$

Use

```
append(sys1, sys2)
```

to specify the block-decoupled LTI model interconnection.

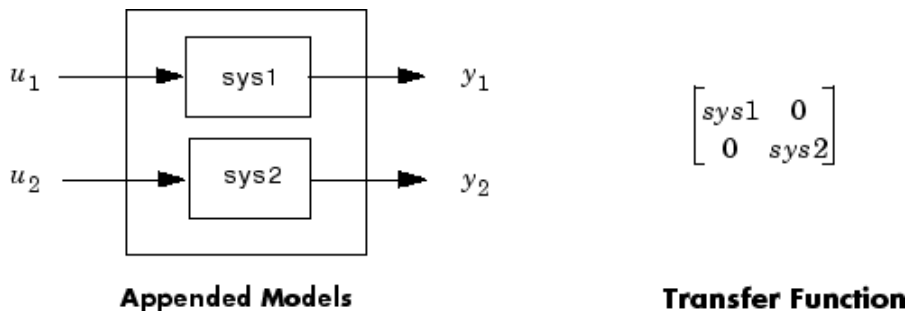

See `append` for more information on this function.

Feedback and Other Interconnection Functions

The following LTI model interconnection functions are useful for specifying closed- and open-loop model configurations:

- `feedback` puts two LTI models with compatible dimensions in a feedback configuration.
- `series` connects two LTI models in series.
- `parallel` connects two LTI models in parallel.
- `lft` performs the Redheffer star product on two LTI models.
- `connect` works with `append` to apply an arbitrary interconnection scheme to a set of LTI models.

For example, if sys1 has m inputs and p outputs, while sys2 has p inputs and m outputs, then the negative feedback configuration of these two LTI models

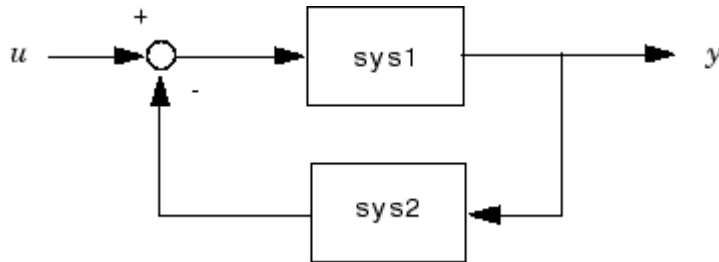

is realized with

```
feedback(sys1, sys2)
```

This specifies the LTI model with m inputs and p outputs whose I/O map is

$$(I + \text{sys1} \cdot \text{sys2})^{-1} \text{sys1}$$

See the reference pages online for more information on `feedback`, `series`, `parallel`, `lft`, and `connect`.

Continuous/Discrete Conversions of LTI Models

In this section...

“Supported Conversion Functions and Methods” on page 2-21

“Zero-Order Hold” on page 2-21

“First-Order Hold” on page 2-23

“Impulse Invariance” on page 2-24

“Tustin Approximation” on page 2-27

“Tustin with Frequency Prewarping” on page 2-28

“Matched Poles and Zeros” on page 2-28

“Discretization of Systems with Delays” on page 2-28

Supported Conversion Functions and Methods

The function `c2d` discretizes continuous-time TF, SS, or ZPK models. Conversely, `d2c` converts discrete-time TF, SS, or ZPK models to continuous time. Several discretization/interpolation methods are supported, including zero-order hold (ZOH), first-order hold (FOH), Tustin approximation with or without frequency prewarping, and matched poles and zeros.

The syntax

```
sysd = c2d(sysc,Ts);    % Ts = sampling period in seconds
sysc = d2c(sysd);
```

performs ZOH conversions by default. To use alternative conversion schemes, specify the desired method as an extra string input:

```
sysd = c2d(sysc,Ts,'foh'); % use first-order hold
sysc = d2c(sysd,'tustin'); % use Tustin approximation
```

Zero-Order Hold

Zero-order hold (ZOH) devices convert sampled signals to continuous-time signals for analyzing sampled continuous-time systems. The zero-order-hold

discretization $H_d(z)$ of a continuous-time LTI model $H(s)$ is depicted in the following block diagram.

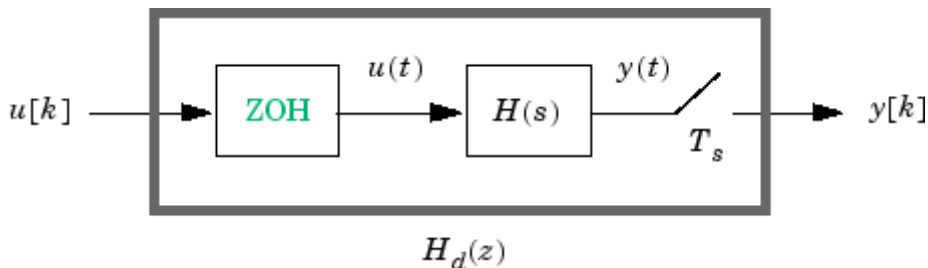

The ZOH device generates a continuous input signal $u(t)$ by holding each sample value $u[k]$ constant over one sample period.

$$u(t) = u[k], \quad kT_s \leq t \leq (k+1)T_s$$

The signal $u(t)$ is then fed to the continuous system $H(s)$, and the resulting output $y(t)$ is sampled every T_s seconds to produce $y[k]$.

Conversely, given a discrete system $H_d(z)$, the d2c conversion produces a continuous system $H(s)$ whose ZOH discretization coincides with $H_d(z)$. This inverse operation has the following limitations:

- d2c cannot operate on LTI models with poles at $z = 0$ when the ZOH is used.
- Negative real poles in the z domain are mapped to *pairs* of complex poles in the s domain. As a result, the d2c conversion of a discrete system with negative real poles produces a continuous system with higher order.

The next example illustrates the behavior of d2c with real negative poles. Consider the following discrete-time ZPK model.

```
hd = zpk([], -0.5, 1, 0.1)
Zero/pole/gain:
      1
-----
(z+0.5)
```

Sampling time: 0.1

Use `d2c` to convert this model to continuous-time

```
hc = d2c(hd)
```

and you get a second-order model.

```
Zero/pole/gain:
  4.621 (s+149.3)
-----
(s^2 + 13.86s + 1035)
```

Discretize the model again

```
c2d(hc,0.1)
```

and you get back the original discrete-time system (up to canceling the pole/zero pair at $z=-0.5$):

```
Zero/pole/gain:
 (z+0.5)
-----
 (z+0.5)^2
```

Sampling time: 0.1

First-Order Hold

First-order hold (FOH) differs from ZOH by the underlying hold mechanism. To turn the input samples $u[k]$ into a continuous input $u(t)$, FOH uses linear interpolation between samples.

$$u(t) = u[k] + \frac{t - kT_s}{T_s}(u[k+1] - u[k]), \quad kT_s \leq t \leq (k+1)T_s$$

This method is generally more accurate than ZOH for systems driven by smooth inputs. Due to causality constraints, this option is only available for `c2d` conversions, and not `d2c` conversions.

Note This FOH method differs from standard causal FOH and is more appropriately called *triangle approximation* (see [2], p. 151). It is also known as *ramp-invariant* approximation because it is distortion-free for ramp inputs.

Impulse Invariance

The impulse invariant mapping matches the discretized impulse response to that of the continuous time system. For example:

```
n=1;d=[1 1]; % Simple 1st order continuous system
sc=ss(tf(n,d)); % state space representation
sd1=c2d(sc,0.01,'imp'); % Convert to discrete system via impulse
% invariant
impz(sc,sd1) % Plot both impulse responses
```

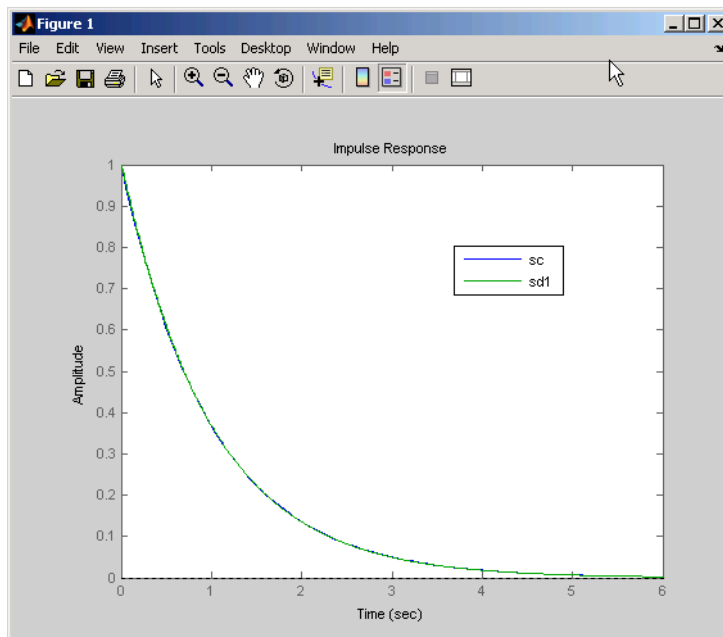

Note that the impulse responses match. The frequency responses do not match, however, because of scaling factor T_s , the sample time. For example,

```
bode(sc,0.01*sd1) % scaled by Ts
```

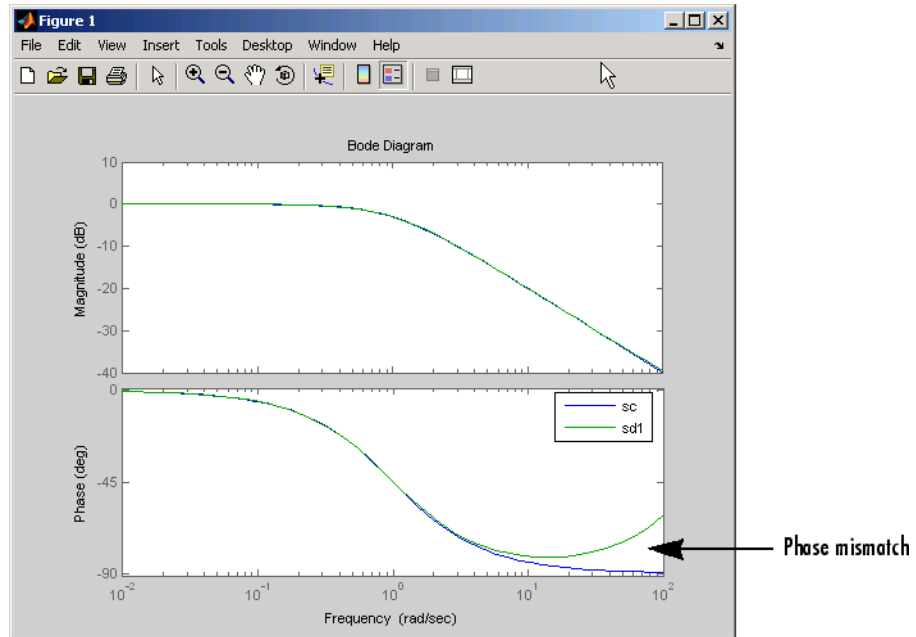

Although the impulse invariant transform is ideal when you are interested in matching the impulse response, it may not be a good choice if you are interested in matching the frequency response of the continuous system, because it is susceptible to aliasing. For example,

```
sd2=c2d(sc,0.2,'imp');
sd3 = c2d(sc,0.5,'imp');
bode(sc,0.01*sd1, 0.2*sd2, 0.5*sd3)
```

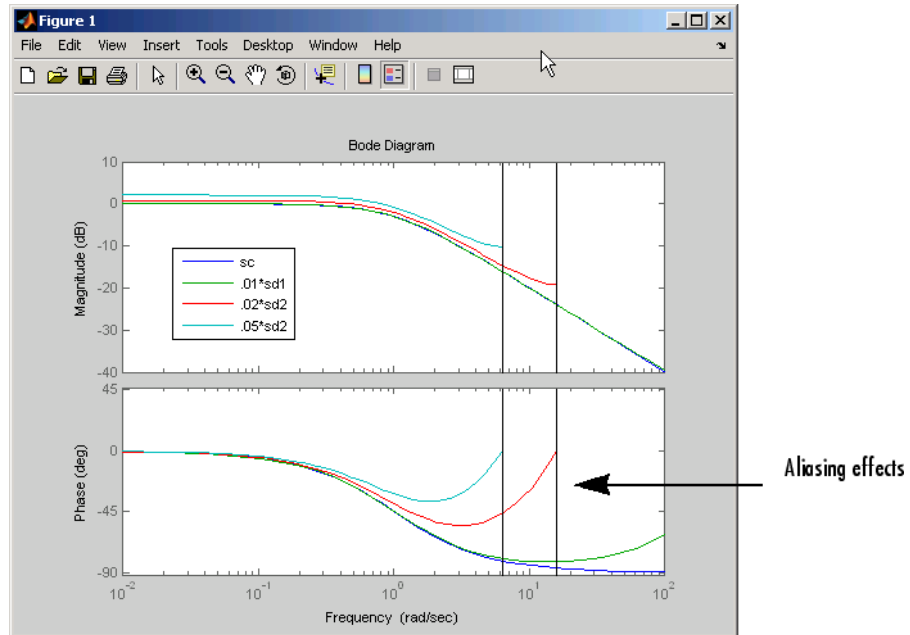

As the sampling time increases, you can see the effects of aliasing. In general, if you are interested in matching the frequency response of the continuous system, a bilinear transform (such as “Tustin Approximation” on page 2-27) is a better choice. For example, using the tustin bilinear transform for the same example,

```
bode(sc,c2d(sc,0.01,'tustin'))
c2d(sc,0.2,'tustin')
c2d(sc,0.5,'tustin')
```

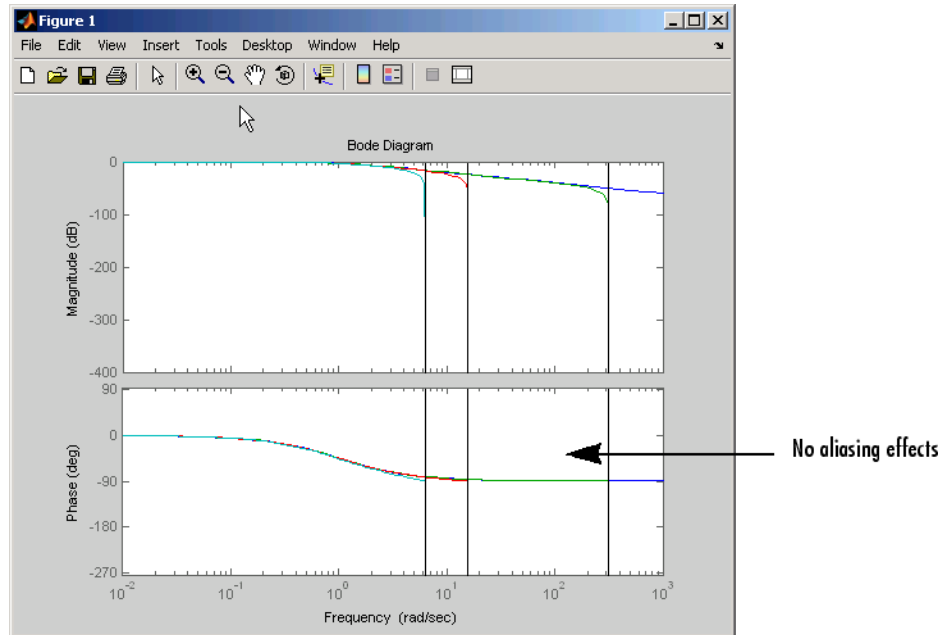

you can see that aliasing is no longer an issue.

See any standard text in digital signal processing for a discussion of impulse invariance scaling issues and aliasing.

Tustin Approximation

The Tustin or bilinear approximation uses the approximation

$$z = e^{sT_s} \approx \frac{1 + sT_s/2}{1 - sT_s/2}$$

to relate s -domain and z -domain transfer functions. In c2d conversions, the discretization $H_d(z)$ of a continuous transfer function $H(s)$ is derived by

$$H_d(z) = H(s'), \text{ where } s' = \frac{2}{T_s} \frac{z-1}{z+1}$$

Similarly, the d2c conversion relies on the inverse correspondence

$$H(s) = H_d(z'), \text{ where } z' = \frac{1 + sT_s/2}{1 - sT_s/2}$$

Tustin with Frequency Prewarping

This variation of the Tustin approximation uses the correspondence

$$H_d(z) = H(s'), \quad s' = \frac{\omega}{\tan(\omega T_s/2)} \frac{z-1}{z+1}$$

This change of variable ensures the matching of the continuous- and discrete-time frequency responses at the frequency ω .

$$H(j\omega) = H_d(e^{j\omega T_s})$$

Matched Poles and Zeros

The matched pole-zero method applies only to SISO systems. The continuous and discretized systems have matching DC gains and their poles and zeros correspond in the transformation

$$z = e^{sT}$$

See [2] for more details.

Discretization of Systems with Delays

You can also use `c2d` to discretize SISO or MIMO continuous-time models with time delays. If T_s is the sampling period used for discretization:

- A delay of τ seconds in the continuous-time model is mapped to a delay of k sampling periods in the discretized model, where $k = \text{fix}(\tau/T_s)$.
- The residual *fractional delay* $\tau - kT_s$ is absorbed into the coefficients of the discretized model (for the zero-order-hold and first-order-hold methods only).

For example, to discretize the transfer function

$$H(s) = e^{-0.25s} \frac{10}{s^2 + 3s + 10}$$

using zero-order hold on the input, and a 10 Hz sampling rate, type

```
h = tf(10,[1 3 10],'inputdelay',0.25);
hd = c2d(h,0.1)
```

This produces the discrete-time transfer function

```
Transfer function:
      0.01187 z^2 + 0.06408 z + 0.009721
z^(-3) * -----
      z^2 - 1.655 z + 0.7408
```

```
Sampling time: 0.1
```

Here the input delay in $H(s)$ amounts to 2.5 times the sampling period of 0.1 seconds. Accordingly, the discretized model `hd` inherits an input delay of two sampling periods, as confirmed by the value of `hd.inputdelay`. The residual half-period delay is factored into the coefficients of `hd` by the discretization algorithm.

The step responses of the continuous and discretized models are compared in the figure below. This plot was produced by the command

```
step(h, '- - ',hd, '-')
```

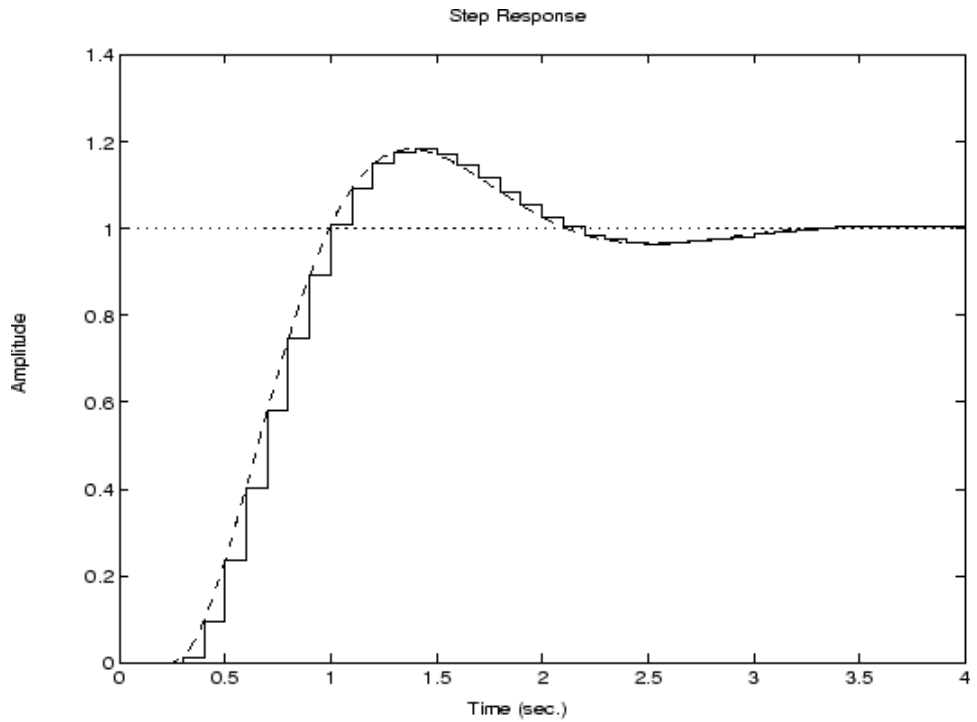

Note The Tustin and matched pole/zero methods are accurate only for delays that are integer multiples of the sampling period. It is therefore preferable to use the zoh and foh discretization methods for models with delays.

Resampling of Discrete-Time Models

In this section...

“Available Commands for Resampling Discrete-Time Models” on page 2-31
 “Example of Resampling a Discrete-Time Model” on page 2-31

Available Commands for Resampling Discrete-Time Models

You can resample a discrete-time TF, SS, or ZPK model using the commands described in the following table.

To...	Use the command...
<ul style="list-style-type: none"> Downsample a system. Upsample a system without any restriction on the new sampling time. 	d2d
Upsample a system with the highest accuracy when: <ul style="list-style-type: none"> The new sample time is integer-value-times faster than the sample time of the original model. Your new model can have more states than the original model. 	upsample

Example of Resampling a Discrete-Time Model

This example shows how to upsample a system using both the d2d and upsample commands and compares the results of both to the original system.

1 Create the original system, h1, by typing:

```
h1 = tf([1 0.4],[1 -0.7],0.3)
```

This command returns the following result:

Transfer function:

$$z + 0.4$$

$$z - 0.7$$

Sampling time: 0.3

The sample time is 0.3 seconds.

- 2** Create a new system with a sampling time of 0.1 seconds using the `d2d` command. Type::

$$h2 = d2d(h1,0.1)$$

This command returns the following result:

Transfer function:

$$z - 0.4769$$

$$z - 0.8879$$

Sampling time: 0.1

The sample time is 0.1 seconds.

- 3** Create another new system with a sampling time of 0.1 seconds using the `upsample` command by typing:

$$h3 = upsample(h1,3)$$

This command returns the following result:

Transfer function:

$$z^3 + 0.4$$

$$z^3 - 0.7$$

Sampling time: 0.1

The sample time is 0.1 seconds and `h3` has three times as many poles and zeros as `h1`.

- 4 Compare the results of the new upsampled systems h2 and h3 to the original system h1. Use step response and bode plots by typing:

```
step(h1, '-r', h2, ':g', h3, '--b')
figure
bode(h1, '-r', h2, ':g', h3, '--b')
```

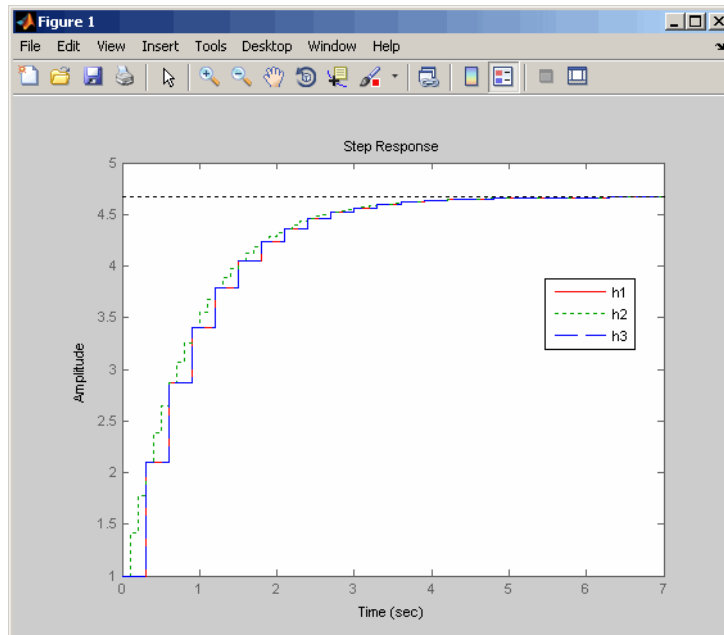

The step response plot shows that the upsampled system h3, created using the `upsample` command, provides a better match than h2 to the original system h1. The h3 system matches h1 at multiples of the original sampling time.

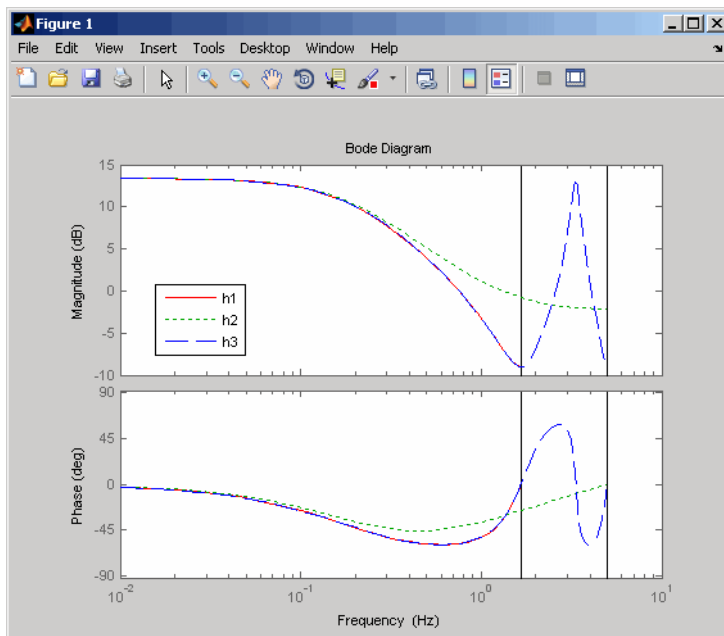

The bode plot shows that the upsampled system h_3 , created using the `upsample` command, provides an exact match of the original system h_1 up to the Nyquist frequency π / Ts_0 , where Ts_0 is the sampling time of the original system.

References

- [1] Åström, K.J. and B. Wittenmark, *Computer-Controlled Systems: Theory and Design*, Prentice-Hall, 1990, pp. 48-52.
- [2] Franklin, G.F., J.D. Powell, and M.L. Workman, *Digital Control of Dynamic Systems*, Second Edition, Addison-Wesley, 1990.

Model Analysis Tools

- “General Model Characteristics” on page 3-2
- “Model Dynamics” on page 3-4
- “State-Space Realizations” on page 3-7

General Model Characteristics

General model characteristics include the model type, I/O dimensions, and continuous or discrete nature. Related commands are listed in the table below. These commands operate on continuous- or discrete-time LTI models or arrays of LTI models of any type.

General Model Characteristics Commands	Description
<code>class</code>	Display model type ('tf', 'zpk', 'ss', or 'frd').
<code>hasdelay</code>	Test true if LTI model has any type of delay.
<code>isa</code>	Test true if LTI model is of specified class.
<code>isct</code>	Test true for continuous-time models.
<code>isdt</code>	Test true for discrete-time models.
<code>isempty</code>	Test true for empty LTI models.
<code>isproper</code>	Test true for proper LTI models.
<code>issiso</code>	Test true for SISO models.
<code>ndims</code>	Display the number of model/array dimensions.
<code>reshape</code>	Change the shape of an LTI array.
<code>size</code>	Output/input/array dimensions. Used with special syntax, <code>size</code> also returns the number of state dimensions for state-space models, and the number of frequencies in an FRD model.

This example illustrates the use of some of these commands. See the related reference pages for more details.

```
H = tf({1 [1 -1]},{[1 0.1] [1 2 10]})
```

```
Transfer function from input 1 to output:
```

```
      1
-----
```



```
s + 0.1

Transfer function from input 2 to output:
      s - 1
-----
s^2 + 2 s + 10

class(H)

ans =
tf

size(H)
Transfer function with 2 input(s) and 1 output(s).

[ny,nu] = size(H) % Note: ny = number of outputs

ny =
    1

nu =
    2

isct(H) % Is this system continuous?

ans =
    1

isdt(H) % Is this system discrete?

ans =
    0
```

Model Dynamics

You can use functions to determine the system poles, zeros, DC gain, norms, etc. You can apply these functions to single LTI models or LTI arrays. The following table gives an overview of these commands.

Model Dynamics	
covar	Covariance of response to white noise.
damp	Natural frequency and damping of system poles.
dcgain	Low-frequency (DC) gain.
dsort	Sort discrete-time poles by magnitude.
esort	Sort continuous-time poles by real part.
norm	Norms of LTI systems (H_2 and L_∞).
pole, eig	System poles.
pzmap	Pole/zero map.
zero	System transmission zeros.

With the exception of L_∞ norm, these commands are not supported for FRD models.

Here is an example of model analysis using some of these commands.

```
h = tf([4 8.4 30.8 60],[1 4.12 17.4 30.8 60])
```

Transfer function:

```
      4 s^3 + 8.4 s^2 + 30.8 s + 60
-----
s^4 + 4.12 s^3 + 17.4 s^2 + 30.8 s + 60
```

```
pole(h)
```

```
ans =
    -1.7971 + 2.2137i
    -1.7971 - 2.2137i
```

```

    -0.2629 + 2.7039i
    -0.2629 - 2.7039i
zero(h)
ans =
    -0.0500 + 2.7382i
    -0.0500 - 2.7382i
    -2.0000
dcgain(h)

ans =
    1

[ninf,fpeak] = norm(h,inf) % peak gain of freq. response

ninf =
1.3402 % peak gain
fpeak =
1.8537 % frequency where gain peaks

```

These functions also operate on LTI arrays and return arrays. For example, the poles of a three dimensional LTI array `sysarray` are obtained as follows.

```

sysarray = tf(rss(2,1,1,3))
Model sysarray(:,:,1,1)
=====
Transfer function:
    -0.6201 s - 1.905
    -----
    s^2 + 5.672 s + 7.405

Model sysarray(:,:,2,1)
=====
Transfer function:
    0.4282 s^2 + 0.3706 s + 0.04264
    -----
    s^2 + 1.056 s + 0.1719

Model sysarray(:,:,3,1)
=====
Transfer function:

```

$$\frac{0.621 s + 0.7567}{s^2 + 2.942 s + 2.113}$$

3x1 array of continuous-time transfer functions.

pole(sysarray)

ans(:,:,1) =

-3.6337

-2.0379

ans(:,:,2) =

-0.8549

-0.2011

ans(:,:,3) =

-1.6968

-1.2452

State-Space Realizations

You can use the following functions to analyze, perform state coordinate transformations on, and derive canonical state-space realizations for single state-space LTI models or LTI arrays of state-space models.

State-Space Realizations	
canon	Canonical state-space realizations.
ctrb	Controllability matrix.
ctrbf	Controllability staircase form.
gram	Controllability and observability gramians.
obsv	Observability matrix.
obsvf	Observability staircase form.
ss2ss	State coordinate transformation.

Arrays of LTI Models

- “Concept of an LTI Array” on page 4-2
- “Dimensions, Size, and Shape of an LTI Array” on page 4-8
- “Building LTI Arrays” on page 4-13
- “Indexing into LTI Arrays” on page 4-22
- “Operations on LTI Arrays” on page 4-27

Concept of an LTI Array

In this section...

“What is an LTI Array?” on page 4-2

“When to Use an LTI Array” on page 4-2

“When to Collect a Set of Models in an LTI Array” on page 4-3

“Restrictions for LTI Models Collected in an Array” on page 4-3

“Where to Find Information on LTI Arrays” on page 4-4

“Visualizing LTI Arrays” on page 4-4

“Higher Dimensional Arrays of LTI Models” on page 4-6

What is an LTI Array?

LTI arrays are arrays that store an LTI models as one element in the array. Since an array in MATLAB technical computing software can be treated as a single variable, so can an LTI array. This means that you can operate on, say, 100 LTI models by one operations on a single variable—making LTI arrays a powerful tool if you have large numbers of LTI models to consider in your analysis and design process.

Because LTI arrays are multidimensional in nature, there is a large set of topics that relate to them. This section discusses these topics:

When to Use an LTI Array

In many applications, it is useful to consider collections of linear, time invariant (LTI) models. For example, you may want to consider a model with a single parameter that varies, such as

```
sys1 = tf(1, [1 1 1]);
```

```
sys2 = tf(1, [1 1 2]);
```

```
sys3 = tf(1, [1 1 3]);
```

and so on. A convenient way to store and analyze a collection like this is to use LTI arrays. Continuing this example, you can create this LTI array and store all three transfer functions in one variable.

```
sys_ltia = (sys1, sys2, sys3);
```

You can use the LTI array `sys_ltia` just like you would use, for example, `sys1`.

You can use LTI arrays to collect a set of LTI models into a single MATLAB variable. You then use this variable to manipulate or analyze the entire collection of models in a vectorized fashion. You access the individual models in the collection through indexing rather than by individual model names.

LTI arrays extend the concept of single LTI models in a similar way to how multidimensional arrays extend two-dimensional matrices in the MATLAB technical computing environment (see Multidimensional Arrays in the MATLAB documentation).

When to Collect a Set of Models in an LTI Array

You can use LTI arrays to represent

- A set of LTI models arising from the linearization of a nonlinear system at several operating points
- A collection of transfer functions that depend on one or more parameters
- A set of LTI models arising from several system identification experiments applied to one plant
- A set of gain-scheduled LTI controllers
- A list of LTI models you want to collect together under the same name

Restrictions for LTI Models Collected in an Array

For each model in an LTI array, the following properties must be the same:

- The number of inputs and outputs
- The sample time, for discrete-time models
- The I/O names and I/O groups

Note You cannot specify Simulink LTI blocks with LTI arrays.

Where to Find Information on LTI Arrays

The next two sections give examples that illustrate how to visualize an LTI array, its dimensions, and size. To read about how to build an LTI array, go to “Building LTI Arrays” on page 4-13. The remainder of the chapter is devoted to indexing and operations on LTI arrays. You can also apply the Control System Toolbox analysis functions to LTI arrays. See Chapter 3, “Model Analysis Tools” for more information on these functions. You can also view response plots of LTI arrays with the LTI Viewer.

Visualizing LTI Arrays

To visualize the concept of an LTI array, consider the set of five transfer function models shown below. In this example, each model has two inputs and two outputs. They differ by parameter variations in the individual model components.

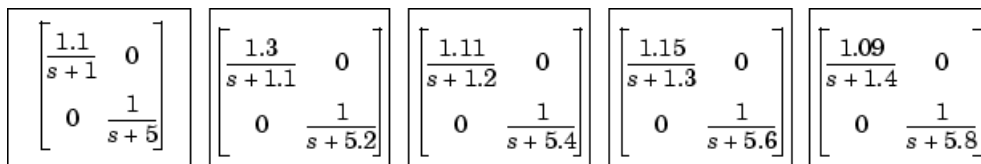
$$\begin{bmatrix} \frac{1.1}{s+1} & 0 \\ 0 & \frac{1}{s+5} \end{bmatrix} \quad \begin{bmatrix} \frac{1.3}{s+1.1} & 0 \\ 0 & \frac{1}{s+5.2} \end{bmatrix} \quad \begin{bmatrix} \frac{1.11}{s+1.2} & 0 \\ 0 & \frac{1}{s+5.4} \end{bmatrix} \quad \begin{bmatrix} \frac{1.15}{s+1.3} & 0 \\ 0 & \frac{1}{s+5.6} \end{bmatrix} \quad \begin{bmatrix} \frac{1.09}{s+1.4} & 0 \\ 0 & \frac{1}{s+5.8} \end{bmatrix}$$

Five LTI Models to be Collected in an LTI Array

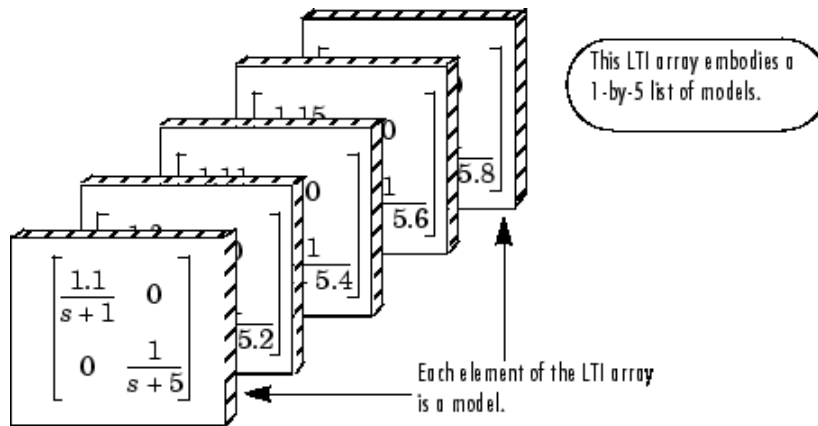

An LTI Array Containing These Five Models

Just as you might collect a set of two-by-two matrices in a multidimensional array, you can collect this set of five transfer function models as a list in an LTI array under one variable name, say, `sys`. Each element of the LTI array is an LTI model.

Individual models in the LTI array `sys` are accessed via indexing. The general form for the syntax you use to access data in an LTI array is

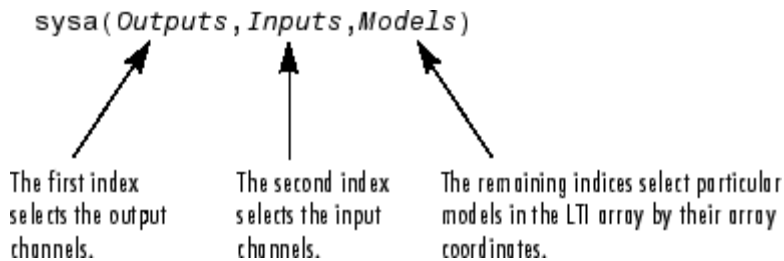

For example, you can access the third model in `sys` with `sys(:, :, 3)`. The following illustrates how you can use indexing to select models or their components from `sys`.

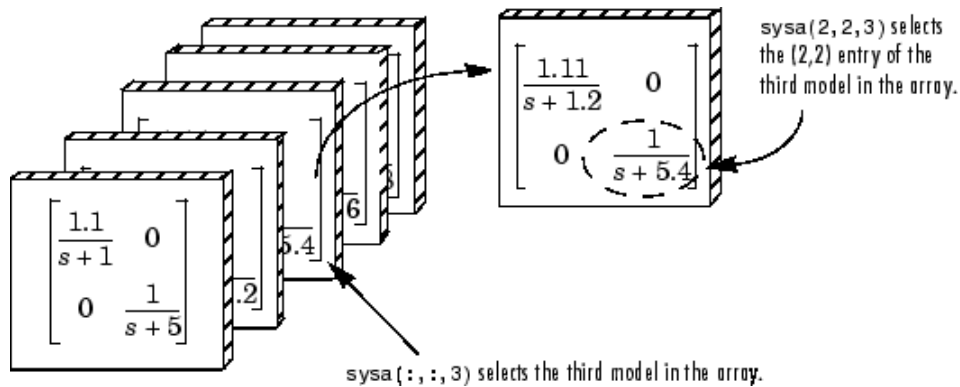

Using Indices to Select Models and Their Components

See “Concept of an LTI Array” on page 4-2 for more information on indexing.

Higher Dimensional Arrays of LTI Models

You can also collect a set of models in a two-dimensional array. The following diagram illustrates a 2-by-3 array of six, two-output, one-input models called `m2d`.

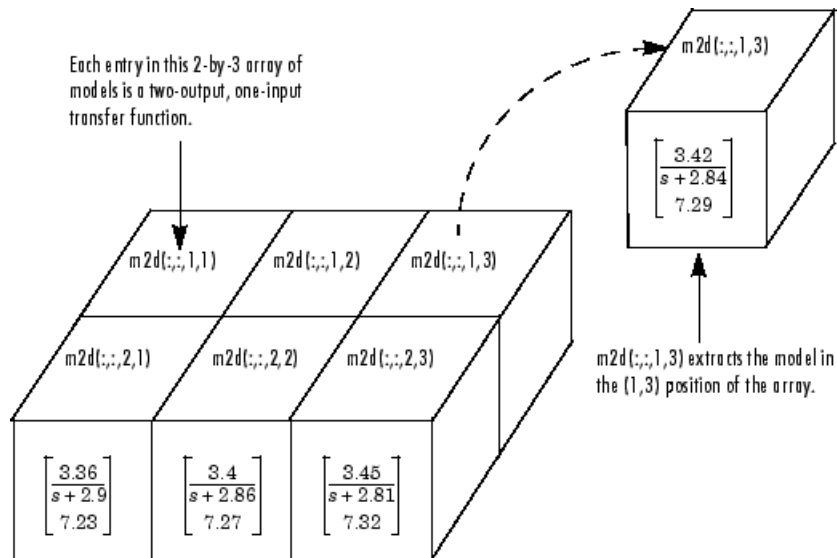

m2d: A 2-by-3 Array of Two-Output, One-Input Models

More generally, you can organize models into a 3-D or higher-dimensional array, in much the same way you arrange numerical data into multidimensional arrays (see Multidimensional Arrays in the MATLAB documentation).

Dimensions, Size, and Shape of an LTI Array

In this section...
“I/O and Array Dimensions of LTI Arrays” on page 4-8
“Accessing the Dimensions of an LTI Array Using size and ndims” on page 4-10
“Using reshape to Rearrange an LTI Array” on page 4-12

I/O and Array Dimensions of LTI Arrays

The dimensions and size of a single LTI model are determined by the output and input channels. An array of LTI models has additional quantities that determine its dimensions, size, and shape.

There are two sets of dimensions associated with LTI arrays:

- The *I/O dimensions*—the output dimension and input dimension common to all models in the LTI array
- The *array dimensions*—the dimensions of the array of models itself

The size of the LTI array is determined by:

- The lengths of the *I/O dimensions*—the number of outputs (or inputs) common to all models in the LTI array
- The length of each array dimension—the number of models along that array dimension

The next figure illustrates the concepts of dimension and size for the LTI array `m2d`, a 2-by-3 array of one-input, two-output transfer function models.

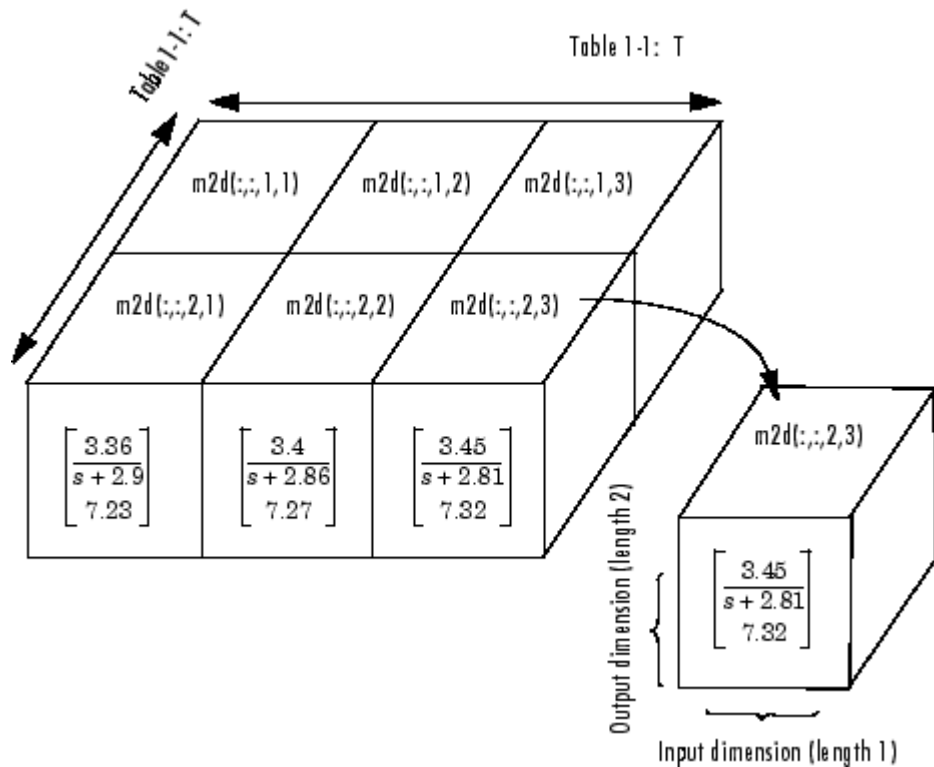

Dimensions and Size of $m2d$, an LTI Array

You can load this sample LTI array into your workspace by typing

```
load LTIexamples
size(m2d)
2x3 array of continuous-time transfer functions
Each transfer function has 2 outputs and 1 input.
```

The I/O dimensions correspond to the row and column dimensions of the transfer matrix. The two I/O dimensions are both of length 1 for SISO models. For MIMO models the lengths of these dimensions are given by the number of outputs and inputs of the model.

Five related quantities are pertinent to understanding the array dimensions:

- N , the number of models in the LTI array
- K , the number of array dimensions
- $S_1 S_2 \dots S_K$, the list of lengths of the array dimensions
 - S_i is the number of models along the i^{th} dimension.
- S_1 -by- S_2 -by- \dots -by- S_K , the configuration of the models in the array
 - The configuration determines the shape of the array.
 - The product of these integers $S_1 \times S_2 \times \dots \times S_K$ is N .

In the example model `m2d`,:

- The length of the output dimension, the first I/O dimension, is 2, since there are two output channels in each model.
- The length of the input dimension, the second I/O dimension, is 1, since there is only one input channel in each model.
- N , the number of models in the LTI array, is 6.
- K , the number of array dimensions, is 2.
- The array dimension lengths are [2 3].
- The array configuration is 2-by-3.

Accessing the Dimensions of an LTI Array Using `size` and `ndims`

You can access the dimensions and shape of an LTI array using

- `size` to determine the lengths of each of the dimensions associated with an LTI array
- `ndims` to determine the total number of dimensions in an LTI array

When applied to an LTI array, `size` returns

```
[Ny Nu S1 S2 ... Sk]
```

where

- N_y is the number of outputs common to all models in the LTI array.
- N_u is the number of inputs common to all models in the LTI array.
- $S_1 S_2 \dots S_k$ are the lengths of the array dimensions of a k -dimensional array of models. S_i is the number of models along the i th array dimension.

Note the following when using the `size` function:

- By convention, a single LTI model is treated as a 1-by-1 array of models. For single LTI models, `size` returns only the I/O dimensions `[Ny Nu]`.
- For LTI arrays, `size` always returns at least two array dimensions. For example, the size of a 2-by-1 LTI array is `[Ny Nu 2 1]`
- `size` ignores trailing singleton dimensions beyond the second array dimension. For example, `size` returns `[Ny Nu 2 3]` for a 2-by-3-by-1-by-1 LTI array of models with N_y outputs and N_u inputs.

The function `ndims` returns the total number of dimensions in an LTI array:

- 2, for single LTI models
- $2 + p$, for LTI arrays, where p (greater than 2) is the number of array dimensions

Note that

```
ndims (sys) = length(size(sys))
```

To see how these work on the sample 2-by-3 LTI array `m2d` of two-output, one-input models, type

```
load LTIexamples
s = size(m2d)
s =
     2     1     2     3
```

Notice that `size` returns a vector whose entries correspond to the length of each of the four dimensions of `m2d`: two outputs and one input in a 2-by-3 array of models. Type

```
ndims(m2d)
```

```
ans =  
    4
```

to see that there are indeed four dimensions attributed to this LTI array.

Using reshape to Rearrange an LTI Array

Use `reshape` to reorganize the arrangement (array configuration) of the models of an existing LTI array.

For example, to arrange the models in an LTI array `sys` as a $w_1 \times \dots \times w_p$ array, type

```
reshape(sys,w1,...,wp)
```

where w_1, \dots, w_p are any set of integers whose product is N , the number of models in `sys`.

You can reshape the LTI array `m2d` into a 3-by-2, a 6-by-1, or a 1-by-6 array using `reshape`. For example, type

```
load LTIexamples  
sys = reshape(m2d,6,1);  
size(sys)
```

```
6x1 array of continuous-time transfer functions  
Each transfer function has 2 outputs and 1 inputs.
```

```
s = size(sys)
```

```
s =  
    2    1    6 1
```

Building LTI Arrays

In this section...

“Ways to Build LTI Arrays” on page 4-13

“Building LTI Arrays Using for Loops” on page 4-13

“Building LTI Arrays Using the stack Function” on page 4-16

“Building LTI Arrays Using tf, zpk, ss, and frd” on page 4-18

“Generating Random LTI Arrays Using rss” on page 4-21

Ways to Build LTI Arrays

There are several ways to build LTI arrays:

- Using a for loop to assign each model in the array
- Using stack to concatenate LTI models into an LTI array
- Using tf, zpk, ss, or frd

In addition, you can use the command rss to generate LTI arrays of random state-space models.

Building LTI Arrays Using for Loops

Consider the following second-order SISO transfer function that depends on two parameters, ζ and ω

$$H(s) = \frac{\omega^2}{s^2 + 2\zeta\omega s + \omega^2}$$

Suppose, based on measured input and output data, you estimate confidence intervals $[\omega_1, \omega_2]$ and $[\zeta_1, \zeta_2]$ for each of the parameters, ω and ζ . All of the possible combinations of the confidence limits for these model parameter values give rise to a set of four SISO models.

	ω_1	ω_2
ζ_1	$H_{11}(s) = \frac{\omega_1^2}{s^2 + 2\zeta_1\omega_1s + \omega_1^2}$	$H_{12}(s) = \frac{\omega_1^2}{s^2 + 2\zeta_2\omega_1s + \omega_1^2}$
ζ_2	$H_{21}(s) = \frac{\omega_2^2}{s^2 + 2\zeta_1\omega_2s + \omega_2^2}$	$H_{22}(s) = \frac{\omega_2^2}{s^2 + 2\zeta_2\omega_2s + \omega_2^2}$

Four LTI Models Depending on Two Parameters

You can arrange these four models in a 2-by-2 array of SISO transfer functions called H .

	ω_1	ω_2
ζ_1	$H(:, :, 1, 1)$	$H(:, :, 1, 2)$ ← Each entry of this 2-by-2 array is a SISO transfer function model.
ζ_2	$H(:, :, 2, 1)$	$H(:, :, 2, 2)$

The LTI Array H

Here, for $i, j \in \{1, 2\}$, $H(:, :, i, j)$ represents the transfer function

$$\frac{\omega_j^2}{s^2 + 2\zeta_i\omega_js + \omega_j^2}$$

corresponding to the parameter values $\zeta = \zeta_i$ and $\omega = \omega_j$.

The first two colon indices (ζ) select all I/O channels from the I/O dimensions of H . The third index of H refers to the first array dimension (ζ), while the fourth index is for the second array dimension (ω).

Suppose the limits of the ranges of values for ζ and ω are [0.66,0.76] and [1.2,1.5], respectively. Enter these at the command line.

```
zeta = [0.66,0.75];
w = [1.2,1.5];
```

Since the four models have the same parametric structure, it's convenient to use two nested for loops to construct the LTI array.

```
for i = 1:2
    for j = 1:2
        H(:, :, i, j) = tf(w(j)^2, [1 2*zeta(i)*w(j) w(j)^2]);
    end
end
```

H now contains the four models in a 2-by-2 array. For example, to display the transfer function in the (1,2) position of the array, type

```
H(:, :, 1, 2)

Transfer function:
      2.25
-----
s^2 + 1.98 s + 2.25
```

For the purposes of efficient computation, you can initialize an LTI array to zero, and then reassign the entire array to the values you want to specify. The general syntax for zero assignment of LTI arrays is

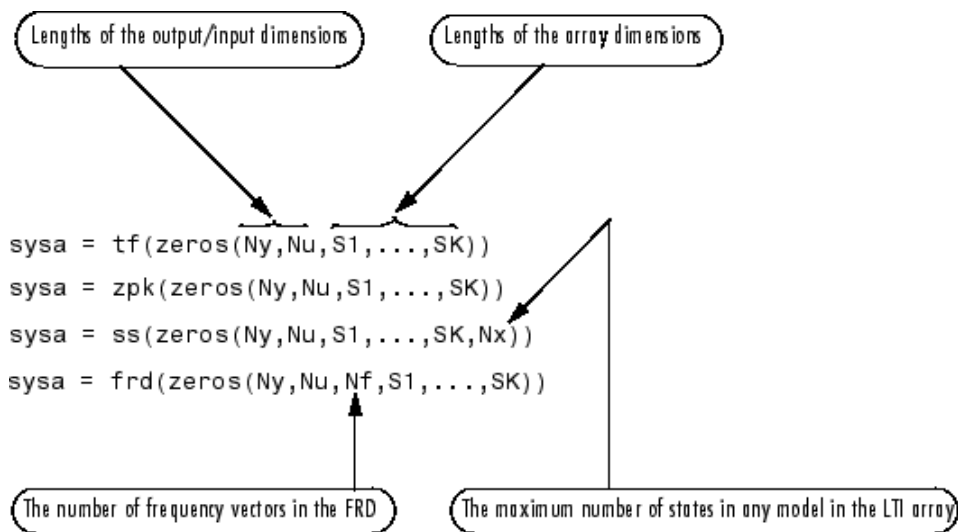

To initialize H in the above example to zero, type

```
H = tf(zeros(1,1,2,2));
```

before you implement the nested for loops.

Building LTI Arrays Using the stack Function

Another way to build LTI arrays is using the function `stack`. This function operates on single LTI models as well as LTI arrays. It concatenates a list of LTI arrays or single LTI models only along the array dimension. The general syntax for `stack` is

```
stack(Arraydim, sys1, sys2...)
```

where

- `Arraydim` is the array dimension along which to concatenate the LTI models or arrays.
- `sys1, sys2, ...` are the LTI models or LTI arrays to be concatenated.

When you concatenate several models or LTI arrays along the j th array dimension, such as in

```
stack(j,sys1,sys2,...,sysn)
```

- The lengths of the I/O dimensions of `sys1, ..., sysn` must all match.
- The lengths of all but the j th array dimension of `sys1, ..., sysn` must match.

For example, if two TF models `sys1` and `sys2` have the same number of inputs and outputs,

```
sys = stack(1,sys1,sys2)
```

concatenates them into a 2-by-1 array of models.

There are two principles that you should keep in mind:

- `stack` only concatenates along an array dimension, not an I/O dimension.
- To concatenate LTI models or LTI arrays along an input or output dimension, use the bracket notation (`[,] ;]`). See “Model Interconnection Functions” on page 2-17 for more information on the use of bracket notation to concatenate models. See also “Special Cases for Operations on LTI Arrays” on page 4-30 for some examples of this type of concatenation of LTI arrays.

Here’s an example of how to build the LTI array `H` using the function `stack`.

```
% Set up the parameter vectors.

zeta = [0.66,0.75];
w = [1.2,1.5];

% Specify the four individual models with those parameters.
%
H11 = tf(w(1)^2,[1 2*zeta(1)*w(1) w(1)^2]);
H12 = tf(w(2)^2,[1 2*zeta(1)*w(2) w(2)^2]);
H21 = tf(w(1)^2,[1 2*zeta(2)*w(1) w(1)^2]);
H22 = tf(w(2)^2,[1 2*zeta(2)*w(2) w(2)^2]);
```

```
% Set up the LTI array using stack.  
  
COL1 = stack(1,H11,H21); % The first column of the 2-by-2 array  
COL2 = stack(1,H12,H22); % The second column of the 2-by-2 array  
H = stack(2, COL1, COL2); % Concatenate the two columns of models.
```

Notice that this result is very different from the single MIMO LTI model returned by

```
H = [H11,H12;H21,H22];
```

Accessing LTI Arrays of Variable Order

For arrays of state-space models with variable order, you cannot use the dot operator (e.g., `sys.a`) to access arrays. Use the syntax

```
[a,b,c,d] = ssdata(sys,'cell')
```

to extract the state-space matrices of each model as separate cells in the cell arrays `a`, `b`, `c`, and `d`.

Building LTI Arrays Using `tf`, `zpk`, `ss`, and `frd`

You can also build LTI arrays using the `tf`, `zpk`, `ss`, and `frd` constructors. You do this by using multidimensional arrays in the input arguments for these functions.

Specifying Arrays of TF models Using `tf`

For TF models, use

```
sys = tf(num,den)
```

where

- Both `num` and `den` are multidimensional cell arrays the same size as `sys` (see “Accessing the Dimensions of an LTI Array Using `size` and `ndims`” on page 4-10).

- $\text{sys}(i,j,n_1,\dots,n_K)$ is the (i, j) entry of the transfer matrix for the model located in the (n_1, \dots, n_K) position of the array.
- $\text{num}(i,j,n_1,\dots,n_K)$ is a row vector representing the numerator polynomial of $\text{sys}(i,j,n_1,\dots,n_K)$.
- $\text{den}(i,j,n_1,\dots,n_K)$ is a row vector representing denominator polynomial of $\text{sys}(i,j,n_1,\dots,n_K)$.

See “MIMO Transfer Function Models” on page 1-14 for related information on the specification of single TF models.

Specifying Arrays of ZPK Models Using `zpk`

For ZPK models, use

```
sys = zpk(zeros,poles,gains)
```

where

- Both `zeros` and `poles` are multidimensional cell arrays whose cell entries contain the vectors of zeros and poles for each I/O pair of each model in the LTI array.
- `gains` is a multidimensional array containing the scalar gains for each I/O pair of each model in the array.
- The dimensions (and their lengths) of `zeros`, `poles`, and `gains`, determine those of the LTI array, `sys`.

Specifying Arrays of SS Models Using `ss`

To specify arrays of SS models, use

```
sys = ss(a,b,c,d)
```

where `a`, `b`, `c`, and `d` are real- or complex-valued multidimensional arrays of appropriate dimensions. All models in the resulting array of SS models have the same number of states, outputs, and inputs.

Note You cannot use the `ss` constructor to build an array of state-space models with different numbers of states. Use `stack` to build such LTI arrays.

The Size of LTI Array Data for SS Models

The size of the model data for arrays of state-space models is summarized in the following table.

Data	Size (Data)
a	$[N_s N_s S_1 S_2 \dots S_K]$
b	$[N_s N_u S_1 S_2 \dots S_K]$
c	$[N_y N_s S_1 S_2 \dots S_K]$
d	$[N_y N_u S_1 S_2 \dots S_K]$

where

- N_s is the maximum of the number of states in each model in the array.
- N_u is the number of inputs in each model.
- N_y is the number of outputs in each model.
- S_1, S_2, \dots, S_K are the lengths of the array dimensions.

Specifying Arrays of FRD Models Using `frd`

To specify a K -dimensional array of p -output, m -input FRD models for which S_1, S_2, \dots, S_K are the lengths of the array dimensions, use

```
sys = frd(response, frequency, units)
```

where

- frequency is a real vector of n frequency data points common to all FRD models in the LTI array.
- response is a p -by- m -by- n -by- S_1 -by-...-by- S_K complex-valued multidimensional array.
- units is the optional string specifying 'rad/s' or 'Hz'.

Note that for specifying an LTI array of SISO FRD models, response can also be a multidimensional array of 1-by- n matrices whose remaining dimensions determine the array dimensions of the FRD.

Generating Random LTI Arrays Using `rss`

A convenient way to generate arrays of state-space models with the same number of states in each model is to use `rss`. The syntax is

```
rss(N,P,M,sdim1,...,sdimk)
```

where

- N is the number of states of each model in the LTI array.
- P is the number of outputs of each model in the LTI array.
- M is the number of inputs of each model in the LTI array.
- sdim1,...,sdimk are the lengths of the array dimensions.

For example, to create a 4-by-2 array of random state-space models with three states, one output, and one input, type

```
sys = rss(3,2,1,4,2);
size(sys)
```

```
4x2 array of continuous-time state-space models
Each model has 2 outputs, 1 input, and 3 states.
```

Indexing into LTI Arrays

In this section...

“When to Index into LTI Arrays” on page 4-22

“Organization of Indices” on page 4-22

“Note on Indexing into LTI Arrays of FRD Models” on page 4-23

“Accessing Particular Models in an LTI Array” on page 4-23

“Extracting LTI Arrays of Subsystems” on page 4-24

“Reassigning Parts of an LTI Array” on page 4-25

“Deleting Parts of an LTI Array” on page 4-26

When to Index into LTI Arrays

You can index into LTI arrays in much the same way as you would for multidimensional arrays to

- Access models
- Extract subsystems
- Reassign parts of an LTI array
- Delete parts of an LTI array

Organization of Indices

When you index into an LTI array `sys`, the indices should be organized according to the following format

```
sys(Outputs, Inputs,  $n_1, \dots, n_K$ )
```

where

- `Outputs` are indices that select output channels.
- `Inputs` are indices that select input channels.
- n_1, \dots, n_K are indices into the array dimensions that select one model or a subset of models in the LTI array.

Note on Indexing into LTI Arrays of FRD Models

For FRD models, the array indices can be followed by the keyword 'frequency' and some expression selecting a subset of the frequency points as in

```
sys (outputs, inputs, n1,...,nk, 'frequency', SelectedFreqs)
```

See “Referencing FRD Models Through Frequencies” on page 2-8 for details on frequency point selection in FRD models.

Accessing Particular Models in an LTI Array

To access any given model in an LTI array:

- Use colon arguments (:, :) for the first two indices to select all I/O channels.
- The remaining indices specify the model coordinates within the array.

For example, if `sys` is a 5-by-2 array of state-space models defined by

```
sys = rss(4,3,2,5,2);
```

you can access (and display) the model located in the (3,2) position of the array `sys` by typing

```
sys(:, :, 3, 2)
```

If `sys` is a 5-by-2 array of 3-output, 2-input FRD models, with frequency vector [1,2,3,4,5], then you can access the response data corresponding to the middle frequency (3 rad/s), of the model in the (3,1) position by typing

```
sys(:, :, 3, 1, 'frequency', 3.0)
```

To access all frequencies of this model in the array, you can simply type

```
sys(:, :, 3, 1)
```

Single Index Referencing of Array Dimensions

You can also access models using single index referencing of the array dimensions.

For example, in the 5-by-2 LTI array `sys` above, you can also access the model located in the (3,2) position by typing

```
sys(:, :, 8)
```

since this model is in the eighth position if you were to list the 10 models in the array by successively scanning through its entries along each of its columns.

For more information on single index referencing, see [Linear Indexing](#) in the MATLAB online documentation.

Extracting LTI Arrays of Subsystems

To select a particular subset of I/O channels from all the models in an LTI array, use the syntax described in “[Extracting and Modifying Subsystems](#)” on page 2-5. For example,

```
sys = rss(4,3,2,5,2);  
A = sys(1, [1 2])
```

or equivalently,

```
A = sys(1, [1 2], :, :)
```

selects the first two input channels, and the first output channel in each model of the LTI array `A`, and returns the resulting 5-by-2 array of one-output, two-input subsystems.

You can also combine model selection with I/O selection within an LTI array. For example, to access both:

- The state-space model in the (3,2) array position
- Only the portion of that model relating the second input to the first output

type

```
sys(1,2,3,2)
```

To access the subsystem from all inputs to the first two output channels of this same array entry, type

```
sys(1:2,:,3,2)
```

Reassigning Parts of an LTI Array

You can reassign entire models or portions of models in an LTI array. For example,

```
sys = rss(4,3,2,5,2); % 5X2 array of state-space models
H = rss(4,1,1,5,2); % 5X2 array of SISO models
sys(1,2) = H
```

reassigns the subsystem from input two to output one, for all models in the LTI array `sys`. This SISO subsystem of each model in the LTI array is replaced with the LTI array `H` of SISO models. This one-line assignment command is equivalent to the following 10-step nested for loop.

```
for k = 1:5
    for j = 1:2
        sys(1,2,k,j) = H(:, :, k, j);
    end
end
```

Notice that you don't have to use the array dimensions with this assignment. This is because I/O selection applies to all models in the array when the array indices are omitted.

Similarly, the commands

```
sys(:, :, 3, 2) = sys(:, :, 4, 1);
sys(1, 2, 3, 2) = 0;
```

reassign the entire model in the (3,2) position of the LTI array `sys` and the (1,2) subsystem of this model, respectively.

Deleting Parts of an LTI Array

You can use indexing to delete any part of an LTI array by reassigning it to be empty (`[]`). For instance,

```
sys = rss(4,3,2,5,2);  
sys(1,:) = [];  
size(sys)
```

```
5x2 array of continuous-time state-space models  
Each model has 2 outputs, 2 inputs, and 4 states.
```

deletes the first output channel from every model of this LTI array.

Similarly,

```
sys(:,:[3 4],:) = []
```

deletes the third and fourth rows of this two-dimensional array of models.

Operations on LTI Arrays

In this section...

- “Supported Operations on LTI Arrays” on page 4-27
- “Example: Addition of Two LTI Arrays” on page 4-28
- “Dimension Requirements” on page 4-29
- “Special Cases for Operations on LTI Arrays” on page 4-30
- “Other Operations on LTI Arrays” on page 4-32

Supported Operations on LTI Arrays

Using LTI arrays, you can apply almost all of the basic model operations that work on single LTI models to entire sets of models at once. These basic operations include

- The arithmetic operations: +, -, *, /, \, ', .'
- The functions: concatenation along I/O dimensions ([,], [;]), `feedback`, `append`, `series`, `parallel`, and `lft`

When you apply any of these operations to two (or more) LTI arrays (for example, `sys1` and `sys2`), the operation is implemented on a model-by-model basis. Therefore, the k th model of the resulting LTI array is derived from the application of the given operation to the k th model of `sys1` and the k th model of `sys2`.

For example, if `sys1` and `sys2` are two LTI arrays and

$$\text{sysa} = \text{op}(\text{sys1}, \text{sys2})$$

then the k th model in the resulting LTI array `sys` is obtained by adding the k th models in `sys1` to the k th model in `sys2`

$$\text{sysa}(:, :, k) = \text{sys1}(:, :, k) + \text{sys2}(:, :, k)$$

You can also apply any of the response plotting functions such as `step`, `bode`, and `nyquist` to LTI arrays. These plotting functions are also applied on a model by model basis.

Example: Addition of Two LTI Arrays

The following diagram illustrates the addition of two 3-by-1 LTI arrays `sys1+sys2`.

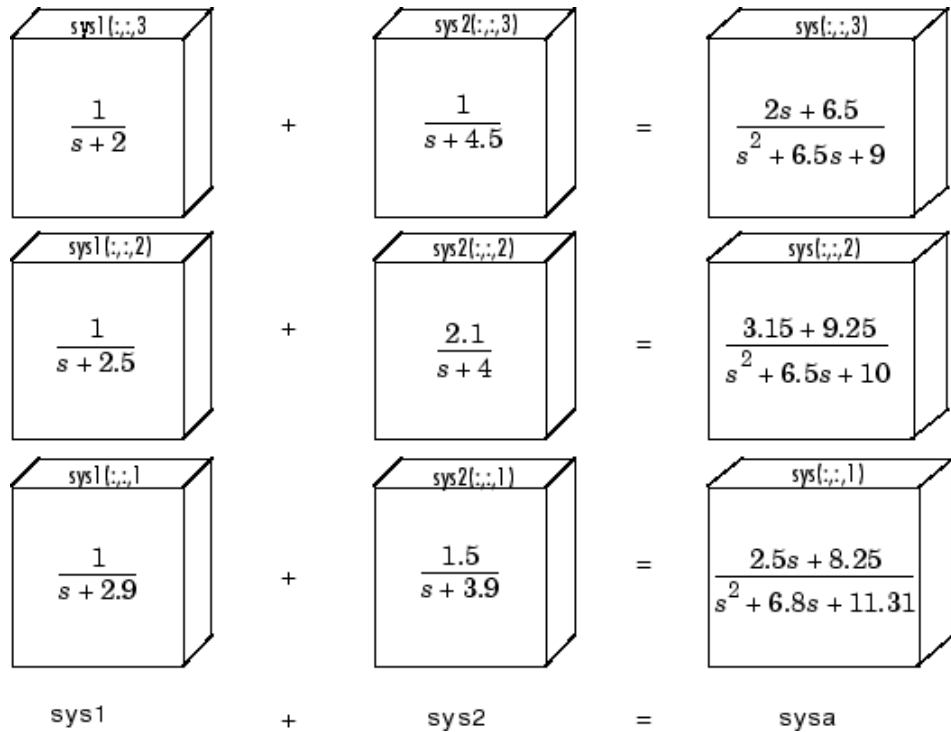

Addition of Two LTI Arrays

The summation of these LTI arrays

$$\text{sysa} = \text{sys1} + \text{sys2}$$

is equivalent to the following model-by-model summation:

```
for k = 1:3
    sysa(:, :, k) = sys1(:, :, k) + sys2(:, :, k)
end
```

Note that:

- Each model in `sys1` and `sys2` must have the same number of inputs and outputs. This is required for the addition of two LTI arrays.
- The lengths of the array dimensions of `sys1` and `sys2` must match.

The following sections describe these topics:

- “Dimension Requirements” on page 4-29
- “Special Cases for Operations on LTI Arrays” on page 4-30
- “Other Operations on LTI Arrays” on page 4-32

Dimension Requirements

In general, when you apply any of these basic operations to two or more LTI arrays:

- The I/O dimensions of each of the LTI arrays must be compatible with the requirements of the operation.
- The lengths of array dimensions must match.

The I/O dimensions of each model in the resulting LTI array are determined by the operation being performed. See Chapter 2, “Operations on LTI Models” for requirements on the I/O dimensions for the various operations.

For example, if `sys1` and `sys2` are both 1-by-3 arrays of LTI models with two inputs and two outputs, and `sys3` is a 1-by-3 array of LTI models with two outputs and 1 input, then

$$\text{sys1} + \text{sys2}$$

is an LTI array with the same dimensions as `sys1` and `sys2`.

$$\text{sys1} * \text{sys3}$$

is a 1-by-3 array of LTI models with two outputs and one input, and

$$[\text{sys1}, \text{sys3}]$$

is a 1-by-3 array of LTI models with two outputs and three inputs.

Special Cases for Operations on LTI Arrays

There are some special cases in coding operations on LTI arrays.

Consider

$$\text{sysa} = \text{op}(\text{sys1}, \text{sys2})$$

where `op` is a symbol for the operation being applied. `sys1` is an LTI array, and `sysa` (the result of the operation) is an LTI array with the same array dimensions as `sys1`. You can use shortcuts for coding `sysa = op(sys1, sys2)` in the following cases:

- For operations that apply to LTI arrays, `sys2` does not have to be an array. It can be a single LTI model (or a gain matrix) whose I/O dimensions satisfy the compatibility requirements for `op` (with those of each of the models in `sys1`). In this case, `op` applies `sys2` to each model in `sys1`, and the k th model in `sys` satisfies

$$\text{sysa}(:, :, k) = \text{op}(\text{sys1}(:, :, k), \text{sys2})$$

- For arithmetic operations, such as `+`, `*`, `/`, and `\`, `sys2` can be either a single SISO model, or an LTI array of SISO models, even when `sys1` is an LTI array of MIMO models. This special case relies on scalar expansion capabilities for arithmetic operations in the MATLAB technical computing environment.
 - When `sys2` is a single SISO LTI model (or a scalar gain), `op` applies `sys2` to `sys1` on an entry-by-entry basis. The ij th entry in the k th model in `sysa` satisfies

$$\text{sysa}(i, j, k) = \text{op}(\text{sys1}(i, j, k), \text{sys2})$$

- When `sys2` is an LTI array of SISO models (or a multidimensional array of scalar gains), `op` applies `sys2` to `sys1` on an entry-by-entry basis for each model in `sysa`.

$$\text{sysa}(i, j, k) = \text{op}(\text{sys1}(i, j, k), \text{sys2}(:, :, k))$$

Examples of Operations on LTI Arrays with Single LTI Models

Suppose you want to create an LTI array containing three models, where, for τ in the set $\{1.1, 1.2, 1.3\}$, each model $H_\tau(s)$ has the form

$$H_\tau(s) = \begin{bmatrix} \frac{1}{s + \tau} & \mathbf{0} \\ -1 & \frac{1}{s} \end{bmatrix}$$

You can do this efficiently by first setting up an LTI array h containing the SISO models $1/(s + \tau)$ and then using concatenation to form the LTI array H of MIMO LTI models $H_\tau(s)$, $\tau \in \{1.1, 1.2, 1.3\}$. To do this, type

```
tau = [1.1 1.2 1.3];
for i=1:3                               % Form LTI array h of SISO models.
    h(:, :, i) = tf(1, [1 tau]);
end
H = [h 0; -1 tf(1, [1 0])]; %Concatenation: array h & single models
size(H)
```

3x1 array of continuous-time transfer functions
Each transfer function has 2 output(s) and 2 input(s).

Similarly, you can use `append` to perform the diagonal appending of each model in the SISO LTI array h with a fixed single (SISO or MIMO) LTI model.

```
S = append(h, tf(1, [1 3])); % Append a single model to h.
```

specifies an LTI array S in which each model has the form

$$S_\tau(s) = \begin{bmatrix} \frac{1}{s + \tau} & \mathbf{0} \\ \mathbf{0} & \frac{1}{s + 3} \end{bmatrix}$$

You can also combine an LTI array of MIMO models and a single MIMO LTI model using arithmetic operations. For example, if `h` is the LTI array of three SISO models defined above,

```
[h,h] + [tf(1,[1 0]);tf(1,[1 5])]
```

adds the single one-output, two-input LTI model $[1/s \ 1/(s + 5)]$ to every model in the 3-by-1 LTI array of one-output, two-input models `[h,h]`. The result is a new 3-by-2 array of models.

Examples: Arithmetic Operations on LTI Arrays and SISO Models

Using the LTI array of one-output, two-input state-space models `[h,h]`, defined in the previous example,

```
tf(1,[1 3]) + [h,h]
```

adds a single SISO transfer function model to each entry in each model of the LTI array of MIMO models `[h,h]`.

Finally,

```
G = rand(1,1,3,1);  
sysa = G + [h,h]
```

adds the array of scalars to each entry of each MIMO model in the LTI array `[h,h]` on a model-by-model basis. This last command is equivalent to the following `for` loop.

```
hh = [h,h];  
for k = 1:3  
    sysa(:, :, k) = G(1,1,k) + hh(:, :, k);  
end
```

Other Operations on LTI Arrays

You can also apply the analysis functions, such as `bode`, `nyquist`, and `step`, to LTI arrays.

Customization Preliminaries

- “Terminology” on page 5-2
- “The Property and Preferences Hierarchy” on page 5-3

Terminology

The Control System Toolbox software provides editors that allow you to set properties and preferences in the SISO Design Tool, the LTI Viewer, and in any response plots that you create from the MATLAB prompt.

Properties refer to settings that are specific to an individual response plot. This includes the following:

- Axes labels, and limits
- Data units and scales
- Plot styles, such as grids, fonts, and axes foreground colors
- Plot characteristics, such as rise time, peak response, and gain and phase margins

Preferences refers to properties that persist either

- Within a single session for a specific instance of an LTI Viewer or a SISO Design Tool
- Across Control System Toolbox sessions

The former are called *tool preferences*, the latter *toolbox preferences*.

The Property and Preferences Hierarchy

This diagram explains the hierarchy from properties, which are local, to toolbox preferences, which are global and persist from session to session.

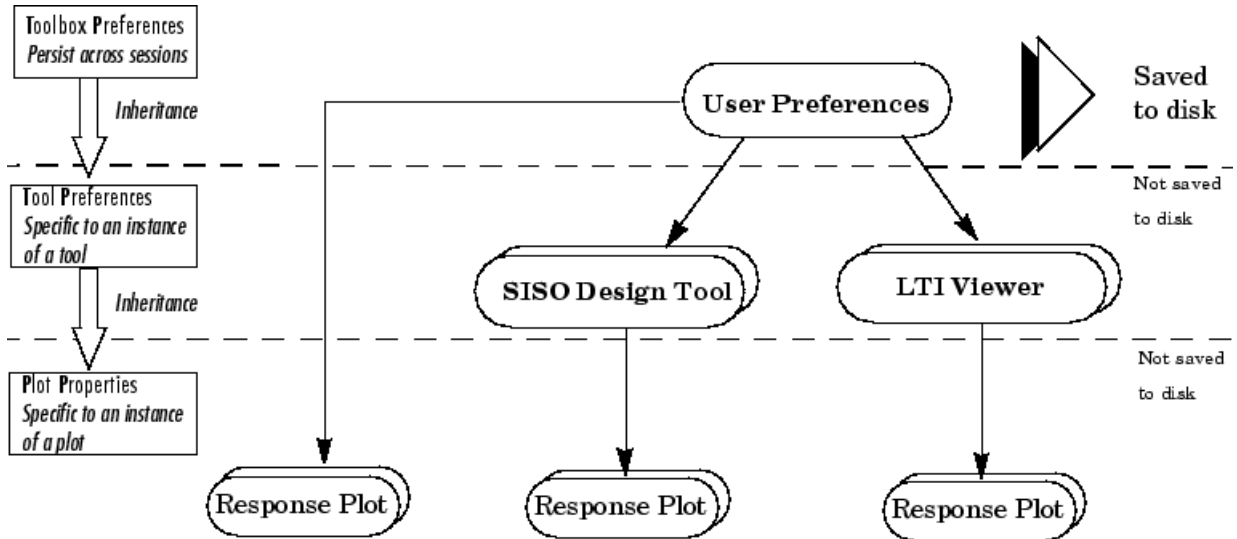

Setting Toolbox Preferences

- “Toolbox Preferences Editor” on page 6-2
- “Units Pane” on page 6-4
- “Style Pane” on page 6-5
- “Options Pane” on page 6-6
- “SISO Tool Pane” on page 6-7

Toolbox Preferences Editor

In this section...

“Overview of the Toolbox Preferences Editor” on page 6-2

“Opening the Toolbox Preferences Editor” on page 6-2

Overview of the Toolbox Preferences Editor

The Toolbox Preferences editor allows you to set plot preferences that will persist from session to session. This is the highest level shown in “Property and Preferences Hierarchy”.

Opening the Toolbox Preferences Editor

To open the Toolbox Preferences editor, select **Toolbox Preferences** from the **File** menu of the LTI Viewer or the SISO Design Tool. Alternatively, you can type

```
ctrlpref
```

at the MATLAB prompt.

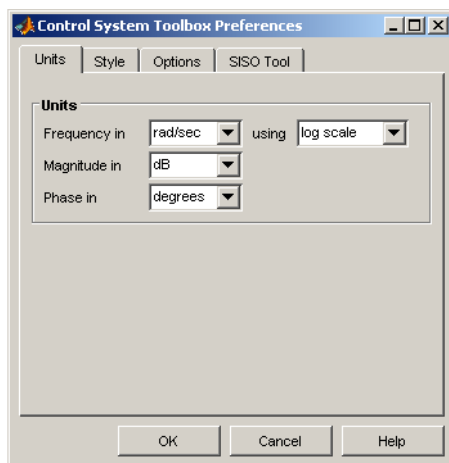

Control System Toolbox Preferences Editor

- “Units Pane” on page 6-4
- “Style Pane” on page 6-5
- “Options Pane” on page 6-6
- “SISO Tool Pane” on page 6-7

Units Pane

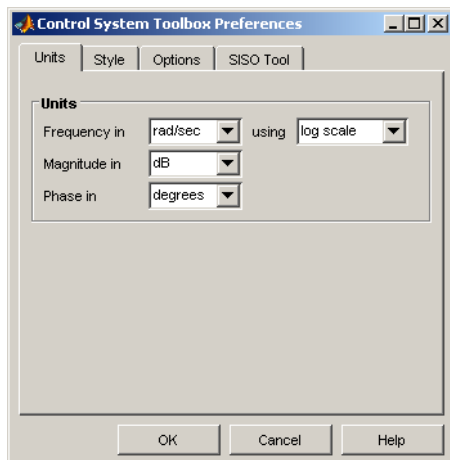

Use the Units pane to set preferences for the following:

- Frequency — Radians per second (rad/s) or Hertz (Hz)
- Magnitude — Decibels (dB) or absolute value (abs)
- Phase — Degrees or radians

For the frequency axis, you can select logarithmic or linear scales.

Style Pane

Use the Style pane to toggle grid visibility and set font preferences and axes foreground colors for all plots you create. This figure shows the Style pane.

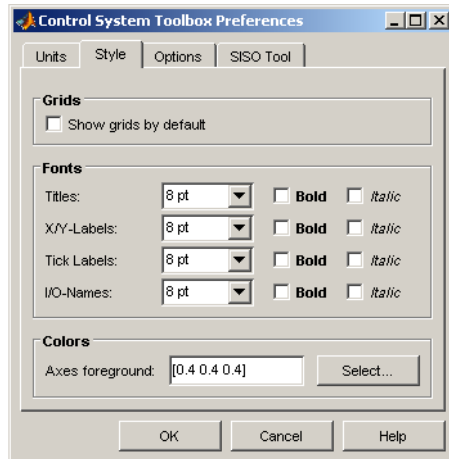

You have the following choices:

- **Grid** — Activate grids by default in new plots.
- **Fonts** — Set the font size, weight (bold), and angle (italic).
- **Colors** — Specify the color vector to use for the axes foreground, which includes the X-Y axes, grid lines, and tick labels. Use a three-element vector to represent red, green, and blue (RGB) values. Vector element values can range from 0 to 1.

If you do not want to specify RGB values numerically, click the **Select** button to open the **Select Colors** dialog box. See “Select colors” on page 7-10 for more information.

Options Pane

The Options pane has selections for time responses and frequency responses. This figure shows the Options pane with default settings.

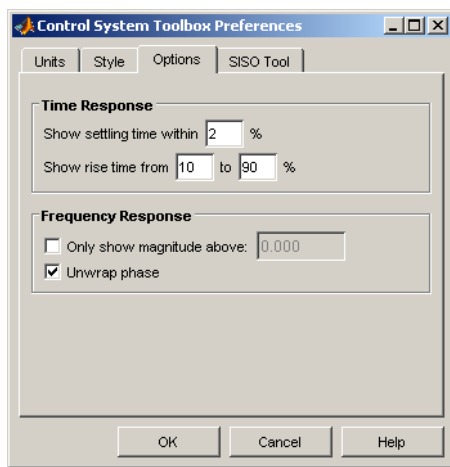

The following are the available options for the Options pane:

- **Time Response:**
 - Show settling time within $xx\%$ — You can set the threshold of the settling time calculation to any percentage from 0 to 100%. The default is 2%.
 - Specify rise time from $xx\%$ to $yy\%$ — The standard definition of rise time is the time it takes the signal to go from 10% to 90% of the final value. You can choose any percentages you like (from 0% to 100%), provided that the first value is smaller than the second.
- **Frequency Response:**
 - Only show magnitude above xx —Specify a lower limit for magnitude values in response plots so that you can focus on a region of interest.
 - Unwrap phase—By default, the phase is unwrapped. Wrap the phase by clearing this box. If the phase is wrapped, all phase values are shifted such that their equivalent value displays in the range $[-180^\circ, 180^\circ)$.

SISO Tool Pane

The SISO Tool pane has settings for the SISO Design Tool. This figure shows the SISO Tool pane with default settings.

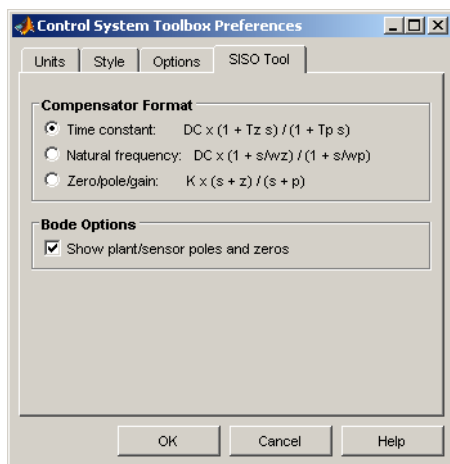

You can make the following selections:

- **Compensator Format** — You can select either the time-constant format, natural frequency format, or the zero/pole/gain format. The time-constant format is

$$dcgain \times \frac{(1 + Tz_1 s)}{(1 + Tp_1 s)} \dots$$

where Tz_1, Tz_2, \dots , are the zero time constants, and Tp_1, Tp_2, \dots , are the pole time constants.

The natural frequency format is

$$dcgain \times \frac{\left(1 + \frac{s}{wz_1}\right)}{\left(1 + \frac{s}{wp_1}\right)} \dots$$

where $\omega_{z1}, \omega_{z2}, \dots$ and $\omega_{p1}, \omega_{p2}, \dots$, are the natural frequencies of the zeros and poles, respectively.

The zero/pole/gain format is a variation on the time-constant format.

$$K \times \frac{(s + z_1)}{(s + p_1)}$$

In this case, the gain is compensator gain; z_1, z_2, \dots and p_1, p_2, \dots , are the zero and pole locations, respectively.

- **Bode Options** — By default, the SISO Design Tool shows the plant and sensor poles and zeros as blue x's and o's, respectively. Clear this box to eliminate the plant's poles and zeros from the Bode plot. Note that the compensator poles and zeros (in red) will still appear.

Setting Tool Preferences

- “Introduction” on page 7-2
- “LTI Viewer Preferences Editor” on page 7-3
- “Graphical Tuning Window Preferences Editor” on page 7-8

Introduction

Both the LTI Viewer and the Graphical Tuning Window have Tool Preferences Editors. These editors comprise the middle layer of “Property and Preferences Hierarchy”.

Both editors allow you to set default characteristics for specific instances of LTI Viewers and Graphical Tuning windows. If you open a new instance of either, each defaults to the characteristics specified in the Toolbox Preferences editor.

LTI Viewer Preferences Editor

In this section...

“Opening the LTI Viewer Preference Editor” on page 7-3

“Units Pane” on page 7-4

“Style Pane” on page 7-4

“Options Pane” on page 7-5

“Parameters Pane” on page 7-6

Opening the LTI Viewer Preference Editor

Select **LTI Viewer Preferences** under the **Edit** menu of the LTI Viewer to open the **LTI Viewer Preferences** editor, which is a tool for customizing various LTI Viewer properties, including units, fonts, and various other viewer characteristics. This figure shows the editor open to its first pane.

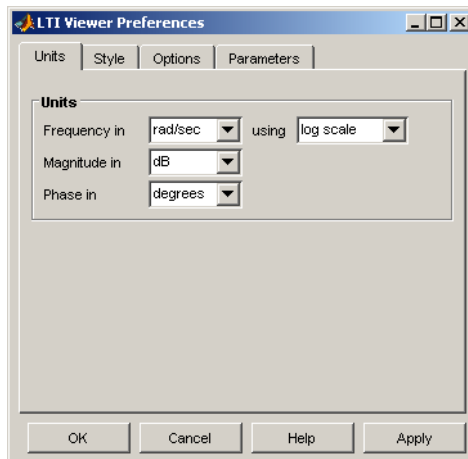

Units Pane

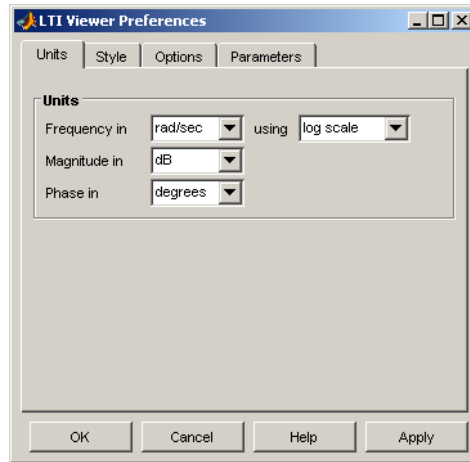

You can select the following on the Units pane:

- Frequency — Radians per second (rad/sec) or Hertz (Hz)
- Magnitude — Decibels (dB) or absolute value (abs)
- Phase — Degrees or radians

For frequency axis, you can select logarithmic or linear scales.

Style Pane

Use the Style pane to toggle grid visibility and set font preferences and axes foreground colors for all plots in the LTI Viewer. This figure shows the Style pane.

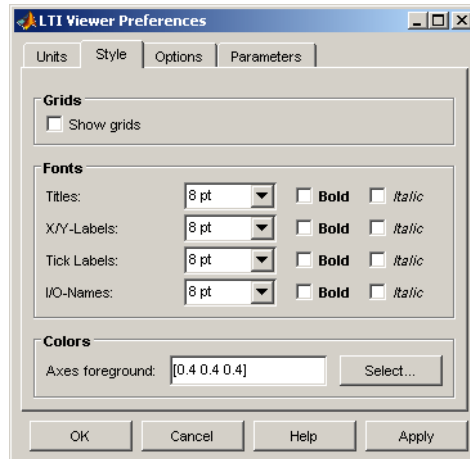

You have the following choices:

- **Grid** — Activate grids for all plots in the LTI Viewer
- **Fonts** — Set the font size, weight (bold), and angle (italic)
- **Colors** — Specify the color vector to use for the axes foreground, which includes the X-Y axes, grid lines, and tick labels. Use a three-element vector to represent red, green, and blue (RGB) values. Vector element values can range from 0 to 1.
- If you do not want to specify the RGB values numerically, press the **Select** button to open the **Select Colors** window. See “Select colors” on page 7-10 for more information.

Options Pane

The Options pane has selections for time responses and frequency responses.

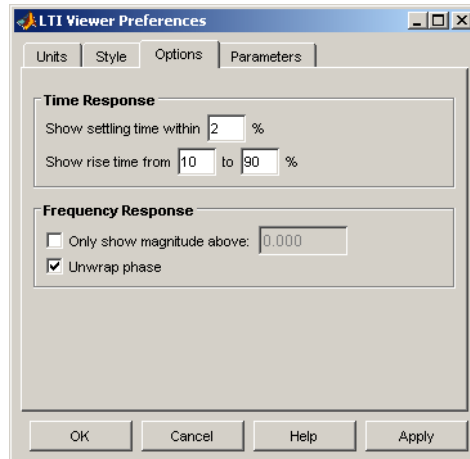

The following choices are available:

- **Time Response:**
 - Show settling time within $xx\%$ — You can set the threshold of the settling time calculation to any percentage from 0 to 100%. The default is 2%.
 - Specify rise time from $xx\%$ to $yy\%$ — The standard definition of rise time is the time it takes the signal to go from 10% to 90% of the final value. You can choose any percentages you like (from 0% to 100%), provided that the first value is smaller than the second.
- **Frequency Response:**
 - Only show magnitude above xx —Specify a lower limit for magnitude values in response plots so that you can focus on a region of interest.
 - Unwrap phase—By default, the phase is unwrapped. Wrap the phrase by clearing this box. If the phase is wrapped, all phase values are shifted such that their equivalent value displays in the range $[-180^\circ, 180^\circ)$.

Parameters Pane

Use the Parameters pane, shown below, to specify input vectors for time and frequency simulation.

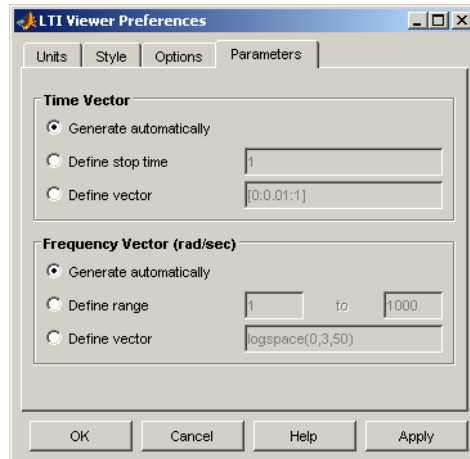

The defaults are to generate time and frequency vectors for your plots automatically. You can, however, override the defaults as follows:

- **Time Vector:**
 - Define stop time — Specify the final time value for your simulation
 - Define vector — Specify the time vector manually using equal-sized time steps
- **Frequency Vector:**
 - Define range — Specify the bandwidth of your response. Whether it's in rad/sec or Hz depends on the selection you made in the Units pane.
 - Define vector — Specify the vector for your frequency values. Any real, positive, strictly monotonically increasing vector is valid.

Graphical Tuning Window Preferences Editor

In this section...

“Opening the Graphical Tuning Window Preferences Editor” on page 7-8

“Units Pane” on page 7-9

“Style Pane” on page 7-9

“Options Pane” on page 7-12

“Line Colors Pane” on page 7-13

Opening the Graphical Tuning Window Preferences Editor

To open the **SISO Tool Preferences** editor, select **SISO Tool Preferences** from the **Edit** menu of the Graphical Tuning window. This window opens.

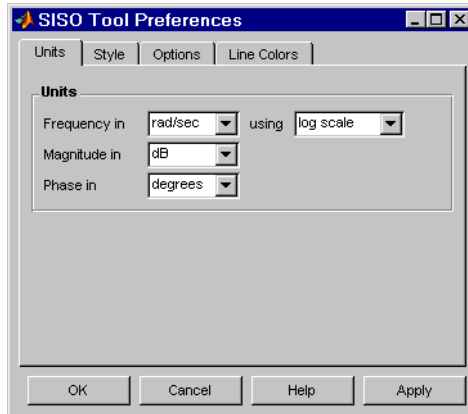

Units Pane

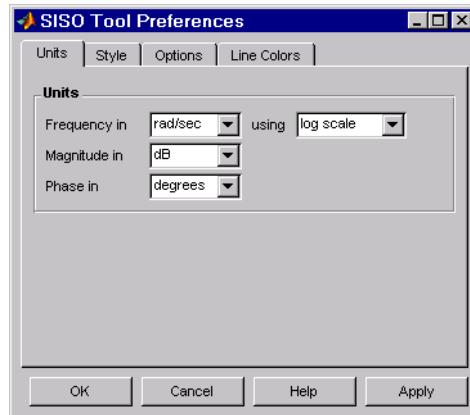

The Units pane has settings for the following units:

- Frequency — Radians per second (rad/sec) or Hertz (Hz)
- Magnitude — Decibels (dB) or absolute value (abs)
- Phase — Degrees or radians

For frequency and magnitude axes, you can select logarithmic or linear scales.

Style Pane

Use the Style pane to toggle grid visibility and set font preferences and axes foreground colors for all plots in the Graphical Tuning Window. This figure shows the Style pane.

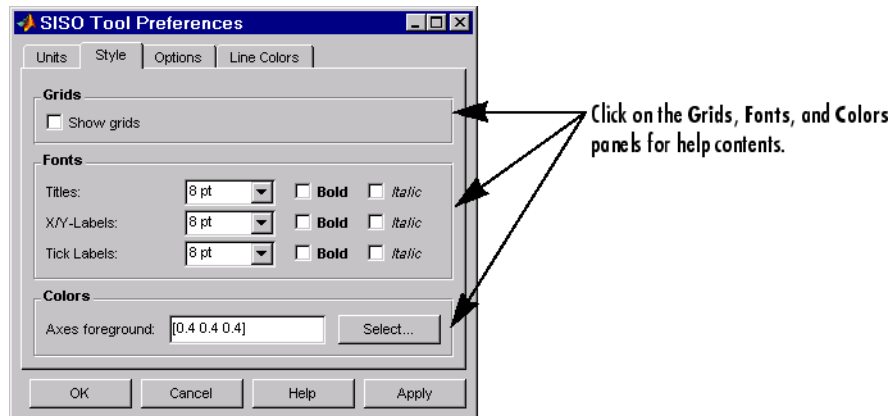

Grids Panel

Select the box to activate grids for all plots in the GRAPHICAL Tuning Window

Fonts Panel

Set the font size, weight (bold), and angle (italic) by using the menus and check boxes.

Colors Panel

Specify the color vector to use for the axes foreground, which includes the X-Y axes, grid lines, and tick labels. Use a three-element vector to represent red, green, and blue (RGB) values. Vector element values can range from 0 to 1.

Select colors. Click the **Select** button to open the Select Color window for the axes foreground.



You can use this window to choose axes foreground colors without having to set RGB (red-green-blue) values numerically. To make your selections, click on the colored rectangles and press OK. If you want a broader range of colors, click the **Define Custom Colors** button. This extends the Select Color window, as shown in this figure.

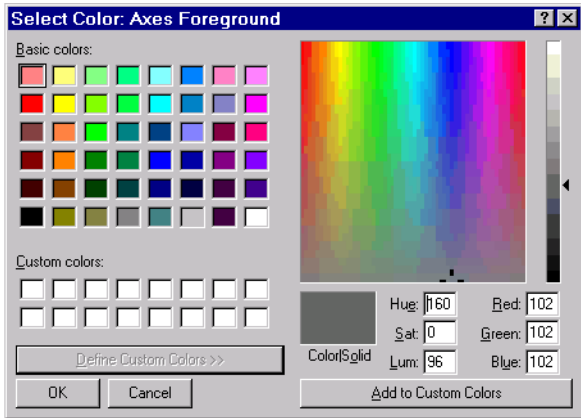

You can pick colors from the color spectrum located in the upper right corner of the window. To select a custom color, follow these steps:

- 1 Place your cursor at a point in the color spectrum that has a color you want to define.

- 2 Left-click. Notice that the hue, saturation, luminescence (lum.), red, green, and blue fields specify the numerical values for the selected color.
- 3 Press **Add to Custom Colors**. This adds the selected color to the row of boxes labeled **Custom Color**. You can now use this color just like the basic colors.

Options Pane

The Options pane, shown below, has selections for compensator format and Bode diagrams.

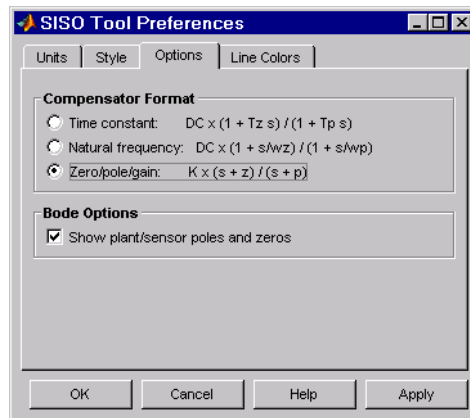

You can make the following selections:

- **Compensator Format** — Select the time constant, natural frequency, or zero/pole/gain format. The time constant format is a factorization of the compensator transfer function of the form

$$dcgain \times \frac{(1 + Tz_1 s)}{(1 + Tp_1 s)} \dots$$

where Tz_1, Tz_2, \dots , are the zero time constants, and Tp_1, Tp_2, \dots , are the pole time constants.

The natural frequency format is

$$dcgain \times \frac{(1 + s/\omega_{z1})}{(1 + s/(\omega_{p1}))} \dots$$

where $\omega_{z1}, \omega_{z2}, \dots$ and $\omega_{p1}, \omega_{p2}, \dots$, are the natural frequencies of the zeros and poles, respectively.

The zero/pole/gain format is

$$K \times \frac{(s + z_1)}{(s + p_1)}$$

where z_1, z_2, \dots and p_1, p_2, \dots , are the zero and pole locations, respectively.

- **Bode Options** — By default, the GRAPHICAL Tuning Window shows the plant and sensor poles and zeros as blue x's and o's, respectively. Clear this check box to eliminate the plant's poles and zeros from the Bode plot. Note that the compensator poles and zeros (in red) will still appear.

Line Colors Pane

The Line Colors pane, shown below, has selections for specify the colors of the lines in the response plots of the Graphical Tuning Window.

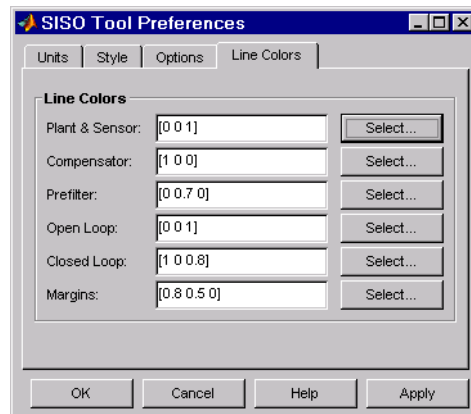

To change the colors of plot lines associated with parts of your model, specify a three-element vector to represent red, green, and blue (RGB) values. Vector element values can range from 0 to 1.

If you do not want to specify the RGB values numerically, click the **Select** button to open the Select Color window. See “Select colors” on page 7-10 for more information.

Customizing Response Plot Properties

- “Introduction” on page 8-2
- “Customizing Response Plots Using the Response Plots Property Editor” on page 8-3
- “Customizing Response Plots Using Plot Tools” on page 8-12
- “Customizing Response Plots from the Command Line” on page 8-16
- “Customizing Plots Inside the SISO Design Tool” on page 8-37

Introduction

The lowest level of the “Property and Preferences Hierarchy” is setting response plot properties. This means that any property you set for a given plot will only affect that plot.

Customizing Response Plots Using the Response Plots Property Editor

In this section...

“Opening the Property Editor” on page 8-3

“Overview of Response Plots Property Editor” on page 8-4

“Labels Pane” on page 8-6

“Limits Pane” on page 8-6

“Units Pane” on page 8-7

“Style Pane” on page 8-8

“Options Pane” on page 8-9

“Editing Subplots Using the Property Editor” on page 8-11

Opening the Property Editor

After you create a response plot, there are two ways to open the Property Editor:

- Double-click in the plot region
- Select **Properties** from the right-click menu

Before looking at the Property Editor, open a step response plot using these commands.

```
load ltiexamples
step(sys_dc)
```

This creates a step plot. Select **Properties** from the right-click menu. Note that when you open the **Property Editor**, a set of black squares appear around the step response, as this figure shows:

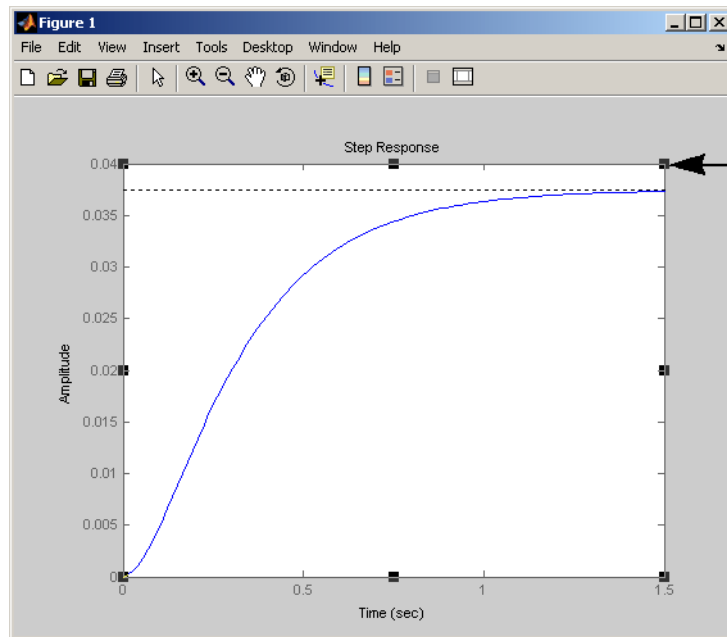

The black squares surrounding the plot indicate that the Property Editor is active for this plot.

SISO System Step Response

Overview of Response Plots Property Editor

This figure shows the **Property Editor** dialog box for a step response.

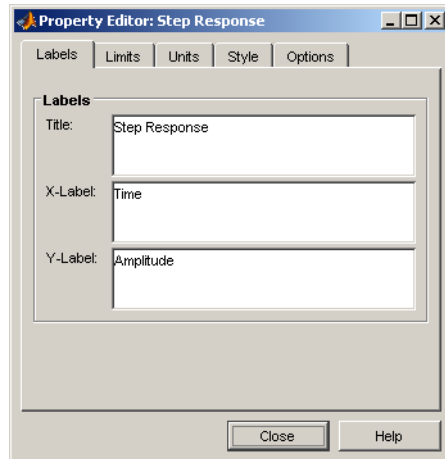

The Property Editor for Step Response

In general, you can change the following properties of response plots. Note that only the **Labels** and **Limits** panes are available when using the **Property Editor** with Simulink® Response Optimization™ software.

- Titles and X- and Y-labels in the **Labels** pane.
- Numerical ranges of the X and Y axes in the **Limits** pane.
- Units where applicable (e.g., rad/s to Hertz) in the **Units** pane.

If you cannot customize units, as is the case with step responses, the Property Editor will display that no units are available for the selected plot.

- Styles in the **Styles** pane.

You can show a grid, adjust font properties, such as font size, bold and italics, and change the axes foreground color

- Change options where applicable in the **Options** pane.

These include peak response, settling time, phase and gain margins, etc. Plot options change with each plot response type. The Property Editor displays only the options that make sense for the selected response plot.

For example, phase and gain margins are not available for step responses.

As you make changes in the Property Editor, they display immediately in the response plot. Conversely, if you make changes in a plot using right-click

menus, the Property Editor for that plot automatically updates. The Property Editor and its associated plot are dynamically linked.

Labels Pane

To specify new text for plot titles and axis labels, type the new string in the field next to the label you want to change. Note that the label changes immediately as you type, so you can see how the new text looks as you are typing.

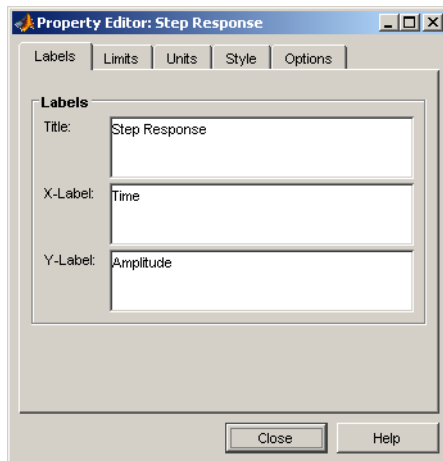

Limits Pane

Default values for the axes limits make sure that the maximum and minimum x and y values are displayed. If you want to override the default settings, change the values in the Limits fields. The **Auto-Scale** box automatically clears if you click a different field. The new limits appear immediately in the response plot.

To reestablish the default values, select the **Auto-Scale** box again.

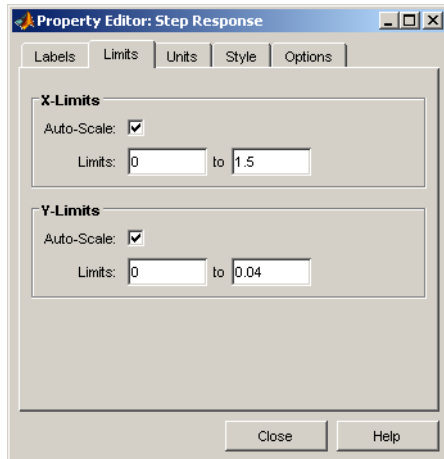

Units Pane

You can use the Units pane to change units in your response plot. The contents of this pane depend on the response plot associated with the editor.

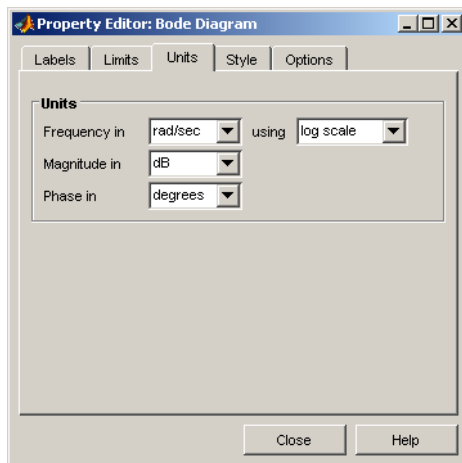

Note that for step and impulse responses, there are no alternate units available (only time and amplitude are possible in the toolbox). This table lists the options available for the other response objects. Use the menus to toggle between units.

Optional Unit Conversions for Response Plots

Response Plot	Unit Conversions
Bode and Bode Magnitude	Frequency in rad/s or Hertz (Hz) using logarithmic or linear scale Magnitude in decibels (dB) or the absolute value Phase in degrees or radians
Impulse	None
Nichols Chart	Frequency in rad/s or Hertz Phase in degrees or radians
Nyquist Diagram	Frequency in rad/s or Hertz
Pole/Zero Map	Frequency in rad/s or Hertz
Singular Values	Frequency in rad/s or Hertz using logarithmic or linear scale Magnitude in decibels or the absolute value using logarithmic or linear scale
Step	None

Style Pane

Use the Style pane to toggle grid visibility and set font preferences and axes foreground colors for response plots.

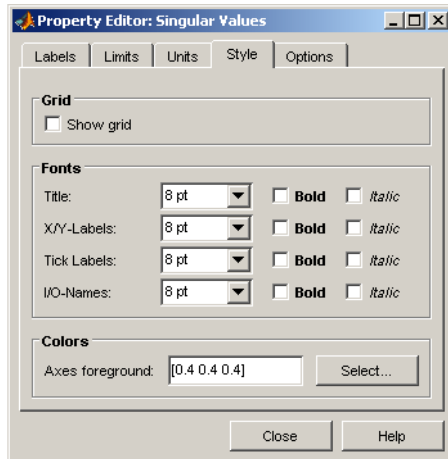

You have the following choices:

- **Grid** — Activate grids by default in new plots.
- **Fonts** — Set the font size, weight (bold), and angle (italic) for fonts used in response plot titles, X/Y-labels, tick labels, and I/O-names.
- **Colors** — Specify the color vector to use for the axes foreground, which includes the X-Y axes, grid lines, and tick labels. Use a three-element vector to represent red, green, and blue (RGB) values. Vector element values can range from 0 to 1.

If you do not want to specify RGB values numerically, click the **Select** button to open the **Select Color** dialog box. See “Select colors” on page 7-10 for more information.

Options Pane

The **Options** pane allows you to customize response characteristics for plots. Each response plot has its own set of characteristics and optional settings; the table below lists them. Use the check boxes to activate the feature and the fields to specify rise or settling time percentages.

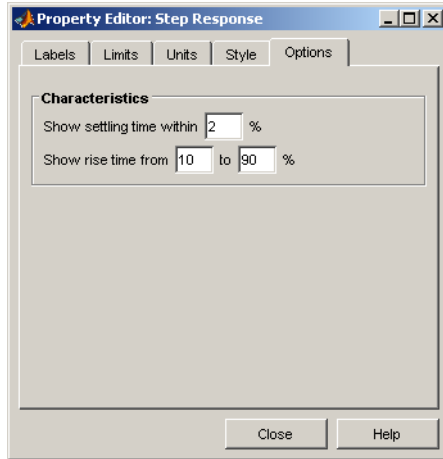

Response Characteristic Options for Response Plots

Plot	Customizable Feature
Bode Diagram and Bode Magnitude	Select lower magnitude limit Adjust phase offsets to keep phase close to a particular value, within a range of $\pm 180^\circ$, at a given frequency. Unwrap phase (default is unwrapped)
Impulse	Show settling time within $xx\%$ (specify the percentage)
Nichols Chart	Select lower magnitude limit Adjust phase offsets to keep phase close to a particular value, within a range of $\pm 180^\circ$, at a given frequency. Unwrap phase (default is unwrapped)
Nyquist Diagram	None
Pole/Zero Map	None

Response Characteristic Options for Response Plots (Continued)

Plot	Customizable Feature
Sigma	None
Step	Show settling time within $xx\%$ (specify the percentage) Show rise time from xx to $yy\%$ (specify the percentages)

Editing Subplots Using the Property Editor

If you create more than one plot in a single figure window, you can edit each plot individually. For example, the following code creates a figure with two plots, a step and an impulse response with two randomly selected systems:

```
subplot(2,1,1)
step(rss(2,1))
subplot(2,1,2)
impulse(rss(1,1))
```

After the figure window appears, double-click in the upper (step response) plot to activate the **Property Editor**. You will see a set of small black squares appear around the step response, indicating that it is the active plot for the editor. To switch to the lower (impulse response) plot, just click once in the impulse response plot region. The set of black squares switches to the impulse response, and the **Property Editor** updates as well.

Customizing Response Plots Using Plot Tools

In this section...
“Properties You Can Customize Using Plot Tools” on page 8-12
“Opening and Working with Plot Tools” on page 8-13
“Example of Changing Line Color Using Plot Tools” on page 8-13

Properties You Can Customize Using Plot Tools

The following table shows the plot properties you can customize using plot tools.

For...	You can customize the following properties:
Responses	<ul style="list-style-type: none"> • System name • Line color • Line style • Line width • Marker type <p>For SISO systems, these changes apply to a single plot line or an array of plot lines representing the system on one axis. For MIMO systems, these changes apply to all of the plotted lines representing the system on multiple axis.</p>
Plot axes	<ul style="list-style-type: none"> • Title • X-label • Y-label
Figures	<ul style="list-style-type: none"> • Figure name • Colormap • Figure color

Note To make other changes to response plots, see “Customizing Response Plots Using the Response Plots Property Editor” on page 8-3 and “Customizing Response Plots from the Command Line” on page 8-16.

Opening and Working with Plot Tools

See the following documentation for information about how to open and work with Plot Tools and the Plot Tools Property Editor:

- “Working in Plot Edit Mode” in the MATLAB documentation.
- “The Property Editor” in the MATLAB documentation.

Example of Changing Line Color Using Plot Tools

To change the line color of a MIMO system plot:

- 1** Create a step response plot of a MIMO system by typing

```
sys_mimo=rss(3,3,3);  
stepplot(sys_mimo)
```

- 2** In the figure window, select **View > Property Editor**.

This action opens the Plot Tools Property Editor.

- 3** Click the plot line in any of the nine axis.

This action selects the response for the `sys_mimo` system and updates the Plot Tools Property Editor to show the available editable properties for the response.

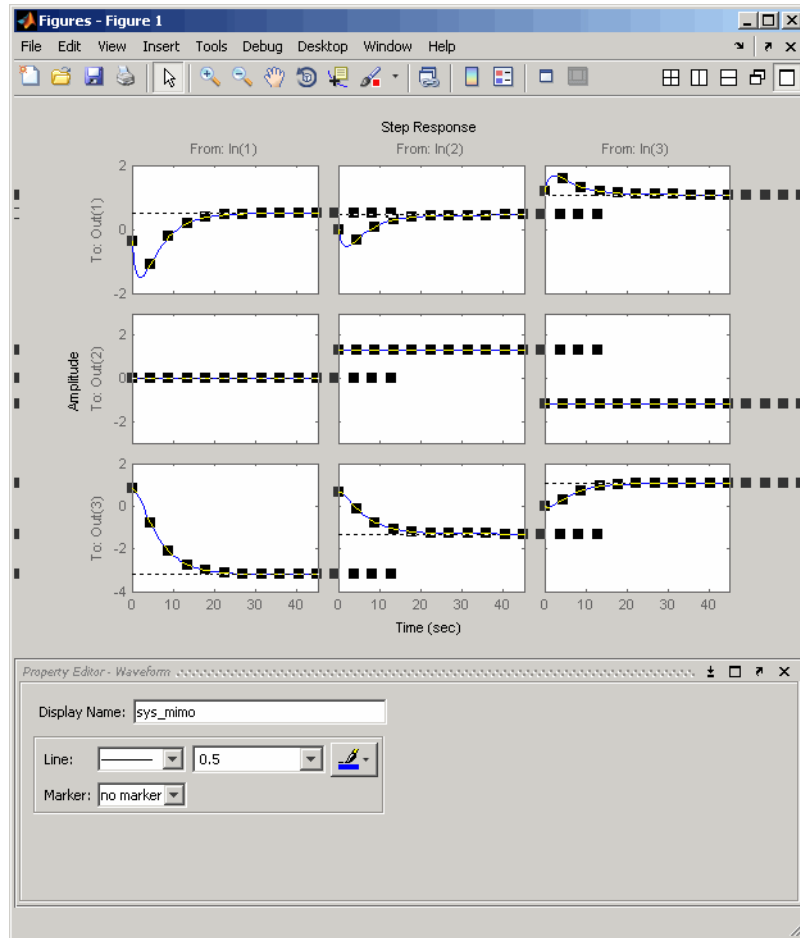

Note The Plot Tools Property Editor applies changes to the response of the MIMO system. Any change you make applies to all of the plotted lines in the figure.

Tip You can also change the properties of the response using the right-click menu while in plot edit mode.

4 In the **Property Editor – Waveform** pane, select the color red.

This action changes the color of the response that represents the MIMO system to red.

Customizing Response Plots from the Command Line

In this section...
“Overview of Customizing Plots from the Command Line” on page 8-16
“Obtaining Plot Handles” on page 8-19
“Obtaining Plot Options Handles” on page 8-20
“Examples of Customizing Plots from the Command Line” on page 8-23
“Properties and Values Reference” on page 8-27
“Property Organization Reference” on page 8-36

Overview of Customizing Plots from the Command Line

- “When to Customize Plots from the Command Line” on page 8-16
- “How to Customize Plots from the Command Line” on page 8-16
- “Example of Changing Bode Plot Units from the Command Line” on page 8-18

When to Customize Plots from the Command Line

You can customize any response plot from the command line. The command line is the most efficient way to customize a large number of plots. For example, if you have a batch job that produces many plots, you can change the x -axis units automatically for all the plot with just a few lines of code.

How to Customize Plots from the Command Line

You can use the Control System Toolbox application program interface (API) to customize plotting options for response plots from the command line.

Note This section assumes some very basic familiarity with Handle Graphics® and object-oriented concepts, namely, classes, objects, and Handle Graphics handles. See “Defining Your Own Classes” and Handle Graphics Objects in the MATLAB online documentation for more information.

To customize plots from the command line:

- 1 Obtain the *plot handle*, which is an identifier for the plot, using the API's plotting syntax.

For example,

```
h=stepplot(sys)
```

returns the plot handle *h* for the step plot.

For more information on obtaining plot handles, see “Obtaining Plot Handles” on page 8-19.

- 2 Obtain the *plot options handle*, which is an identifier for all settable plot options. To get a plot options handle for a given plot, type

```
p=getoptions(h);
```

p is the plot options handle for plot handle *h*.

For more information on obtaining plot options handles, see “Obtaining Plot Options Handles” on page 8-20.

- 3 Use `setoptions`, along with the plot handle and the plot options handle, to access and modify many plot options.

Note You can also use `setoptions` to customize plots using property/value pairs instead of the plot options handle. Using property/value pairs shortens the procedure to one line of code.

Example of Changing Bode Plot Units from the Command Line

You can change of the following plot from rad/s to Hz.

```
s = tf('s');  
sys= 1/(s+1);  
h= bodeplot(sys);
```

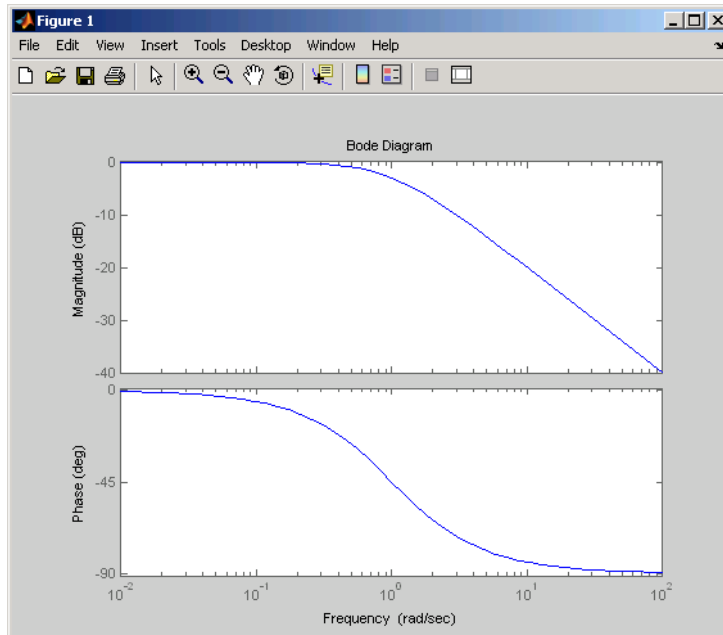

To change the units to Hz, type the following:

```
p = getoptions(h);  
p.FreqUnits = 'Hz';  
setoptions(h,p)
```

The units for the x -axis are now in Hz.

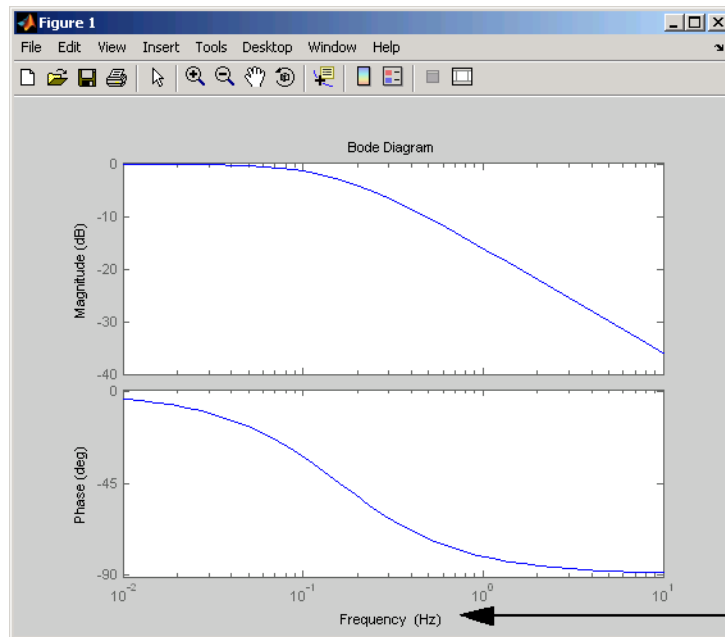

Frequency units are
now in Hz.

Note You can also change the plot units to Hz using property/value pairs by typing

```
setoptions(h, 'FreqUnits', 'Hz');
```

For more examples of customizing plots from the command line, see “Examples of Customizing Plots from the Command Line” on page 8-23.

Obtaining Plot Handles

To programmatically interact with response plot, you need the *plot handle*. This handle is an identifier to the response plot object. Because the Control System Toolbox plotting commands, `bode`, `rlocus`, etc., all use the plot handle internally, this API provides a set of commands that explicitly return the handle to your response plot. These functions all end with “plot,” which makes them easy to identify. This table lists the functions.

Functions That Return the Plot Handle

Function	Plot
bodeplot	Bode magnitude and phase
hsvplot	Hankel singular values
impzplot	Impulse response
initialplot	Initial condition
iozplot	Pole/zero maps for input/output pairs
lsimplot	Time response to arbitrary inputs
nicholsplot	Nichols chart
nyquistplot	Nyquist
pzplot	Pole/zero
rlocusplot	Root locus
sigmaplot	Singular values of the frequency response
stepplot	Step response

To get a plot handle for any response plot, use the functions from the table. For example,

```
h = bodeplot(sys)
```

returns plot handle `h` (it also renders the Bode plot). Once you have this handle, you can modify the plot properties using the `setoptions` and `getoptions` methods of the plot object, in this case, a Bode plot handle.

Obtaining Plot Options Handles

- “Overview of Plot Options Handles” on page 8-21
- “Retrieving a Handle” on page 8-21
- “Creating a Handle” on page 8-21
- “Which Properties Can You Modify?” on page 8-22

Overview of Plot Options Handles

Once you have the plot handle, you need the *plot options handle*, which is an identifier for all the settable plot properties for a given response plot. There are two ways to create a plot options handle:

- Retrieving a Handle — Use `getoptions` to get the handle.
- Creating a Handle — Use `<responseplot>options` to instantiate a handle. See *Functions for Creating Plot Options Handles* on page 8-22 for a complete list.

Retrieving a Handle

The `getoptions` function retrieves a plot options handle from a plot handle.

```
p=getoptions(h) % Returns plot options handle p for plot handle h.
```

If you specify a property name as an input argument, `getoptions` returns the property value associated with the property name.

```
property_value=getoptions(h,PropertyName) % Returns a property  
% value.
```

Creating a Handle

You can create a default plot options handle by using functions in the form of

```
<responseplot>options
```

For example,

```
p=bodeoptions;
```

instantiates a handle for Bode plots. See “Properties and Values Reference” on page 8-27 for a list of default values.

If you want to set the default values to the Control System Toolbox default values, pass `cstprefs` to the function. For example,

```
p = bodeoptions('cstprefs');
```

set the Bode plot property/value pairs to the Control System Toolbox default values.

This table lists the functions that create a plot options handle.

Functions for Creating Plot Options Handles

Function	Type of Plot Options Handle Created
bodeoptions	Bode phase and magnitude
hsvoptions	Hankel singular values
nicholsoptions	Nichols plot
nyquistoptions	Nyquist plot
pzoptions	Pole/zero plot
sigmaoptions	Sigma (singular values) plot
timeoptions	Time response (impulse, step, etc.)

Which Properties Can You Modify?

Use

```
help <responseplot>options
```

to see a list of available property value pairs that you can modify. For example,

```
help bodeoptions
```

```
BODEOPTIONS Create a BodePlotOptions object
```

```
P = BODEOPTIONS returns the default BodePlotOptions object.
```

```
P = BODEOPTIONS('cstprefs') initializes the BodePlotOptions object
```

```
with the Control System Toolbox preferences.
```

```
Available options include:
```

```
Title, XLabel, YLabel          Label text and style
```

TickLabel	Tick label style
Grid [off on]	Show or hide the grid
XlimMode, YlimMode	Limit modes
Xlim, Ylim	Axes limits
IOWGrouping	Grouping of input-output pairs
[none inputs output all]	
InputLabels, OutputLabels	Input and output label styles
InputVisible, OutputVisible	Visibility of input and output channels
FreqUnits [Hz rad/s]	Frequency Units
FreqScale [linear log]	Frequency Scale
MagUnits [dB abs]	Magnitude Units
MagScale [linear log]	Magnitude Scale
MagVisible [on off]	Magnitude plot visibility
MagLowerLimMode [auto manual]	Enables a lower magnitude limit
MagLowerLim	Specifies the lower magnitude limit
PhaseUnits [deg rad]	Phase units
PhaseVisible [on off]	Phase plot visibility
PhaseWrapping [on off]	Enables phase wrapping
PhaseMatching [on off]	Enables phase matching
PhaseMatchingFreq	Frequency for matching phase
PhaseMatchingValue	The value to make the phase responses close to

You can modify any of these parameters using `setoptions`. The next section provides examples of modifying various response plots.

See “Properties and Values Reference” on page 8-27 for a complete list of property/value pairs for response plots.

Examples of Customizing Plots from the Command Line

- “Manipulating Plot Options Handles” on page 8-24

- “Changing Plot Units” on page 8-24
- “Create Plots Using Existing Plot Options Handle” on page 8-25
- “Creating a Default Plot Options Handle” on page 8-26
- “Using Dot Notation Like a Structure” on page 8-26
- “Setting Property Pairs in setoptions” on page 8-27

Manipulating Plot Options Handles

There are two fundamental ways to manipulate plot option handles:

- Dot notation — Treat the handle like a MATLAB structure.
- Property value pairs — Specify property/value pairs explicitly as input arguments to `setoptions`.

For some examples, both dot notation and property/value pairs approaches are shown. For all examples, use

```
sys=tf(1,[1 1])
```

for the system.

Changing Plot Units

Change the frequency units of a Bode plot from rad/s to Hz.

```
h = bodeplot(sys);  
p = getoptions(h);  
p.FreqUnits = 'Hz'  
setoptions(h,p)
```

or, for the last three lines, substitute

```
setoptions(h, 'FreqUnits', 'Hz')
```

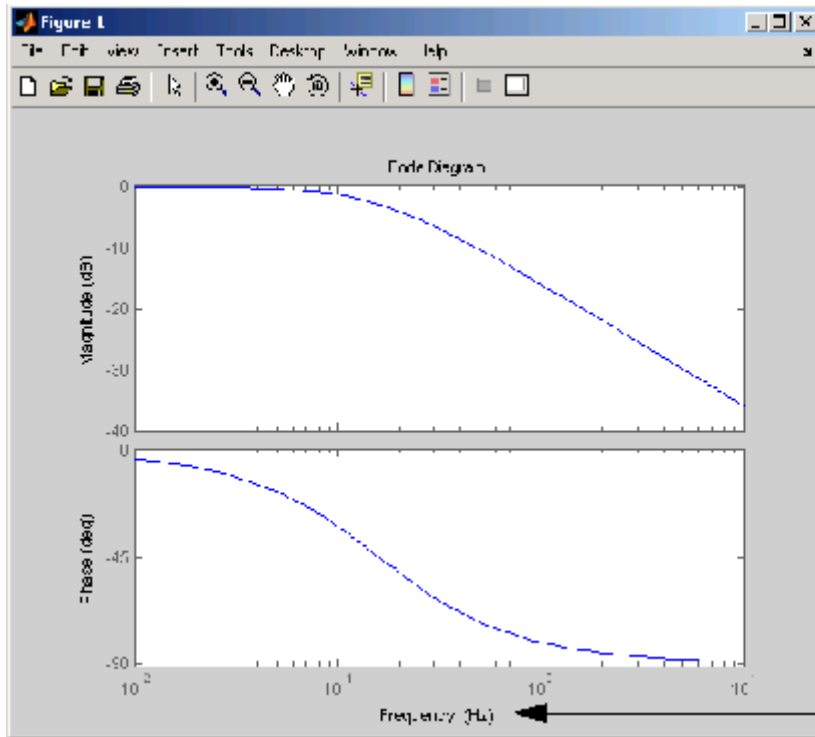
Frequency units are
now in Hz.

Create Plots Using Existing Plot Options Handle

You can use an existing plot options handle to customize a second plot:

```
h1 = bodeplot(sys);
p1 = getoptions(h1);
h2 = bodeplot(sys,p1);
```

or

```
h1 = bodeplot(sys);
h2 = bodeplot(sys2);
setoptions(h2,getoptions(h1))
```

Creating a Default Plot Options Handle

Instantiate a plot options handle with this code.

```
p = bodeoptions;
```

Change the frequency units and apply the changes to sys.

```
p.FreqUnits = 'Hz';  
h = bodeplot(sys,p);
```

Using Dot Notation Like a Structure

You can always use dot notation to assign values to properties.

```
h1 = bodeplot(sys)  
p1 = getoptions(h1)  
p1.FreqUnits = 'Hz'  
p1.Title.String = 'My Title';  
setoptions(h1,p1)
```

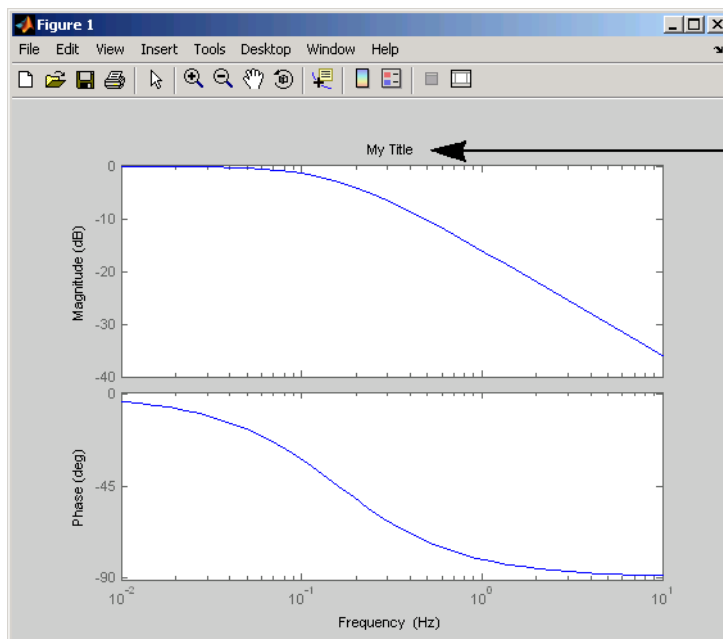

Setting Property Pairs in setoptions

Instead of using dot notation, specify frequency units as property/value pairs in setoptions.

```
h1 = bodeplot(sys)
setoptions(h1, 'FreqUnits', 'Hz')
```

Verify that the units have changed from rad/s to Hz.

```
getoptions(h1, 'FreqUnits') % Returns frequency units for h1.

ans =

Hz
```

Properties and Values Reference

- “Property/Value Pairs Common to All Response Plots” on page 8-27
- “Bode Plots” on page 8-32
- “Hankel Singular Values” on page 8-33
- “Nichols Plots” on page 8-33
- “Nyquist Charts” on page 8-34
- “Pole/Zero Maps” on page 8-34
- “Sigma Plots” on page 8-34
- “Time Response Plots” on page 8-35

Property/Value Pairs Common to All Response Plots

The following tables discuss property/value pairs common to all response plots.

Title

Property	Default Value	Description
Title.String	none	String

Title (Continued)

Property	Default Value	Description
Title.FontSize	8	Double
Title.FontWeight	normal	[light normal demi bode]
Title.FontAngle	normal	[normal italic oblique]
Title.Color	[0 0 0]	1-by-3 RGB vector

X Label

Property	Default Value	Description
XLabel.String	none	String
XLabel.FontSize	8	Double
XLabel.FontWeight	normal	[light normal demi bode]
XLabel.FontAngle	normal	[normal italic oblique]
XLabel.Color	[0 0 0]	1-by-3 RGB vector

Y Label

Property	Default Value	Description
YLabel.String	none	String
YLabel.FontSize	8	Double
YLabel.FontWeight	normal	[light normal demi bode]

Y Label (Continued)

Property	Default Value	Description
YLabel.FontAngle	normal	[normal italic oblique]
YLabel.Color	[0 0 0]	1-by-3 RGB vector

Tick Label

Property	Default Value	Description
TickLabel.FontSize	8	Double
TickLabel.FontWeight	normal	[light normal demo bode]
TickLabel.FontAngle	normal	[normal italic oblique]
Ticklabel.Color	[0 0 0]	1-by-3 RGB vector

Grid and Axis Limits

Property	Default Value	Description
grid	off	[on off]
Xlim	{[]}	A cell array of 1-by-2 doubles that specifies the <i>x</i> -axis limits when XLimMode is set to manual. When XLim is scalar, scalar expansion is applied; otherwise the length of the cell array must equal the number of columns (i.e., number of system inputs) for the plot. The 1-by-2 doubles must be a strictly increasing pair [xmin, xmax].

Grid and Axis Limits (Continued)

Property	Default Value	Description
XLimMode	{auto}	A cell array of strings [auto manual] that specifies the <i>x</i> -axis limits mode. When XLimMode is set to manual the limits are set to the values specified in XLim. When XLimMode is scalar, scalar expansion is applied; otherwise the length of the cell array must equal the number of columns (i.e., number of system inputs) for the plot.
YLim	{[]}	A cell array of 1-by-2 doubles specifies the <i>y</i> -axis limits when YLimMode is set to manual. When YLim is scalar, scalar expansion is applied; otherwise the length of the cell array must equal the number of rows (i.e., number of system outputs) for the plot. The 1-by-2 doubles must be a strictly increasing pair [ymin, ymax].
YLimMode	{auto}	A cell array of strings [auto manual] that specifies the <i>y</i> -axis limits mode. When YLimMode is set to manual the limits are set to the values specified in YLim. When YLimMode is scalar, scalar expansion is applied; otherwise the length of the cell array must equal the number of columns (i.e., number of system inputs) for the plot.

I/O Grouping

Property	Default Value	Description
IOWGrouping	none	[none inputs outputs all] Specifies input/output groupings for responses.

Input Labels

Property	Default Value	Description
InputLabels.FontSize	8	Double
InputLabels.FontWeight	normal	[light normal demi bode]
InputLabels.FontAngle	normal	[normal italic oblique]
InputLabels.Color	[0 0 0]	1-by-3 RGB vector

Output Labels

Property	Default Value	Description
OutputLabel.FontSize	8	Double
OutputLabels.FontWeight	normal	[light normal demi bode]
OutputLabels.FontAngle	normal	[normal italic oblique]
OutputLabels.Color	[0 0 0]	1-by-3 RGB vector

Input/Output Visible

Property	Default Value	Description
InputVisible	{on}	[on off] A cell array that specifies the visibility of each input channel. If the value is a scalar, scalar expansion is applied.
OutputVisible	{on}	[on off] A cell array that specifies the visibility of each output channel. If the value is a scalar, scalar expansion is applied.

Bode Plots

Property	Default Value	Description
FreqUnits	rad/sec	[rad/sec Hz]
FreqScale	log	[linear log]
MagUnits	dB	[db abs]
MagScale	linear	[linear log]
PhaseUnits	deg	[rad deg]
PhaseWrapping	off	[on off]
MagVisible	on	[on off]
PhaseVisible	on	[on off]
MagLowerLimMode	auto	[auto manual] Enables a manual lower magnitude limit specification by MagLowerLim.

Property	Default Value	Description
MagLowerLim	0	Double Specifies the lower magnitude limit when MagLowerLimMode is set to manual.
PhaseMatching	off	[on off] Enables adjusting phase effects for phase response.
PhaseMatchingFreq	0	Double
PhaseMatchingValue	0	Double

Hankel Singular Values

Property	Default Value	Description
Yscale	linear	[linear log]
AbsTol	0	Double See hsvd and stabsep for details.
RelTol	1*e-08	Double See hsvd and stabsep for details.
Offset	1*e-08	Double See hsvd and stabsep for details.

Nichols Plots

Property	Default Value	Description
FreqUnits	rad/sec	[rad/sec Hz]
MagUnits	dB	[dB abs]
PhaseUnits	deg	[rad deg]
MagLowerLimMode	auto	[auto manual]
MagLowerLim	0	double

Property	Default Value	Description
PhaseMatching	off	[on off]
PhaseMatchingFreq	0	Double
PhaseMatchingValue	0	Double

Nyquist Charts

Property	Default Value	Description
FreqUnits	rad/sec	[rad/sec Hz]
MagUnits	dB	[dB abs]
PhaseUnits	deg	[rad deg]
ShowFullContour	on	[on off]

Pole/Zero Maps

Property	Default Value	Description
FreqUnits	rad/sec	[rad/sec Hz]

Sigma Plots

Property	Default Value	Description
FreqUnits	rad/sec	[rad/sec Hz]
FreqScale	log	[linear log]
MagUnits	dB	[dB abs]
MagScale	linear	[linear log]

Time Response Plots

Property	Default Value	Description
Normalize	off	[on off] Normalize the <i>y</i> -scale of all responses in the plot.
SettleTimeThreshold	0.02	Double Specifies the settling time threshold. 0.02 = 2%.
RiseTimeLimits	[0.1, 0.9]	1-by-2 double Specifies the limits used to define the rise time. [0.1, 0.9] is 10% to 90%.

Property Organization Reference

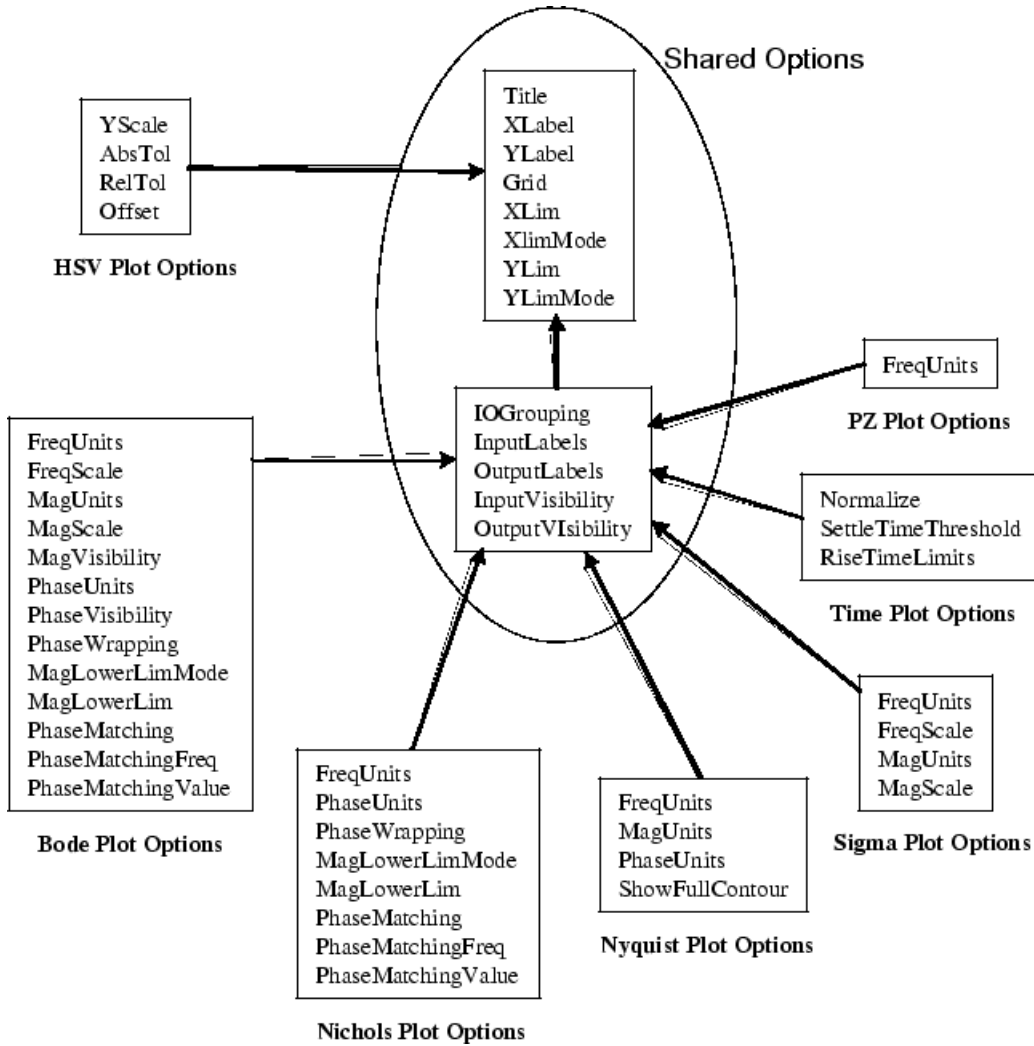

Customizing Plots Inside the SISO Design Tool

In this section...

“Overview of Customizing SISO Design Tool Plots” on page 8-37

“Root Locus Property Editor” on page 8-37

“Open-Loop Bode Property Editor” on page 8-41

“Open-Loop Nichols Property Editor” on page 8-43

“Prefilter Bode Property Editor” on page 8-45

Overview of Customizing SISO Design Tool Plots

Customizing plots inside the SISO Design Tool is similar to how you customize any response plot. The following property editors are specific to the SISO Design Tool:

- Root Locus Property Editor
- Open-Loop Bode Property Editor
- Open-Loop Nichols Property Editor
- Prefilter Bode Property Editor

You can use each of these property editors to create the customized plots within the SISO Design tool.

Root Locus Property Editor

There are three ways to open the Property Editor for root locus plots:

- Double-click in the root locus away from the curve
- Select **Properties** from the right-click menu
- Select **Root Locus** and then **Properties** from Edit in the menu bar

This figure shows the **Property Editor: Root Locus** window.

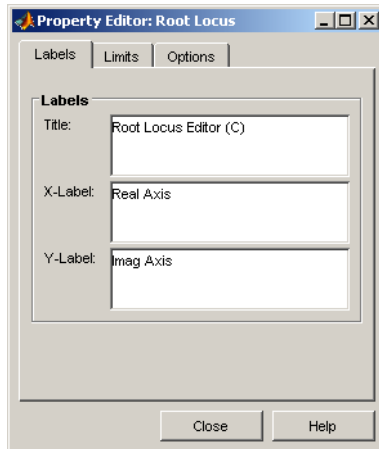

- “Labels Pane” on page 8-38
- “Limits Pane” on page 8-39
- “Options Pane” on page 8-40

Labels Pane

You can use the **Label** pane to specify plot titles and axis labels. To specify a new label, type the string in the appropriate field. The root locus plot automatically updates.

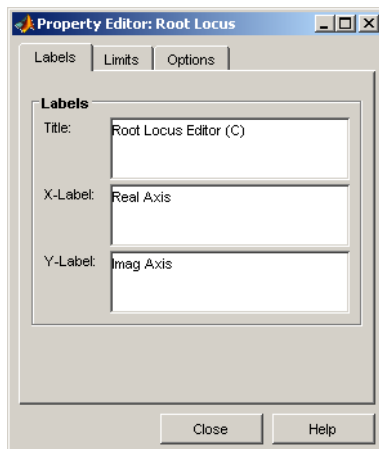

Limits Pane

The SISO Design Tool specifies default values for the real and imaginary axes ranges to make sure that all the poles and zeros in your model appear in the root locus plot. Use the Limits pane, shown below, to override the default settings.

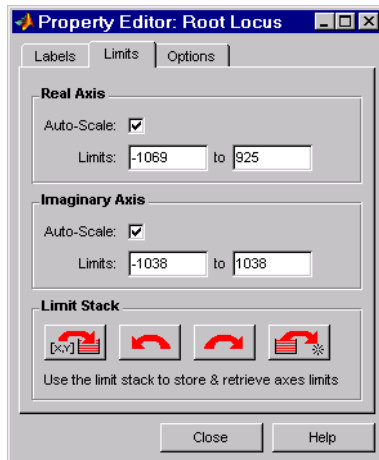

To change the limits, specify the new limits in the real and imaginary axes **Limits** fields. The **Auto-Scale** check box automatically clears once you click in a different field. Your root locus diagram updates immediately. If you want to reapply the default limits, select the **Auto-Scale** check boxes again.

The Limit Stack pane provides support for storing and retrieving custom limit specifications. There are four buttons available:



— Add the current limits to the stack



— Retrieve the previous stack entry



— Retrieve the next stack entry



— Remove the current limits from the stack

Using these buttons, you can store and retrieve any number of saved custom axes limits.

Options Pane

The Options pane contains settings for adding a grid and changing the plot's aspect ratio.

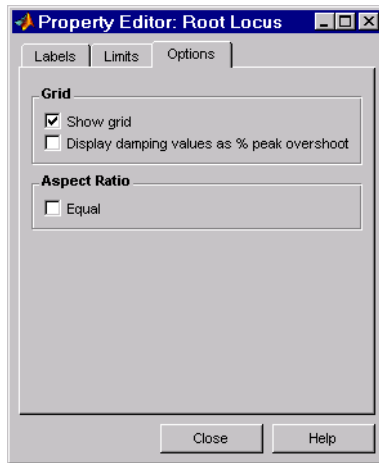

Select **Show grid** to display a grid on the root locus. If you have damping ratio constraints on your root locus, selecting **Display damping ratios as % peak overshoot** displays the damping ratio values along the grid lines. This figure shows both options activated for an imported model, `Gservo`. If you want to verify these settings, type

```
load ltexamples
```

at the MATLAB prompt and import `Gservo` from the workspace into your SISO Design Tool.

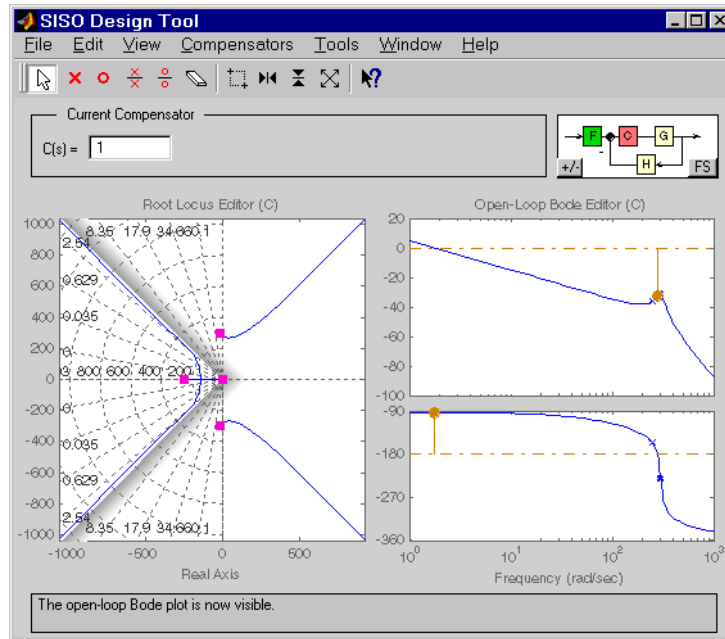

Displaying Damping Ratio Values

The numbers displayed on the root locus gridlines are the damping ratios as a percentage of the overshoot values.

If you select the **Equal** check box in the **Aspect Ratio** pane, the x and y -axes are set to equal limit values.

Open-Loop Bode Property Editor

As is the case with the root locus Property Editor, there are three ways to open the Bode diagram property editor:

- Double-click in the Bode magnitude or phase plot away from the curve.
- Select **Properties** from the right-click menu.
- Select **Open-Loop Bode** and then **Properties** from **Edit** in the menu bar.

This figure shows the **Property Editor: Open-Loop Bode** editor.

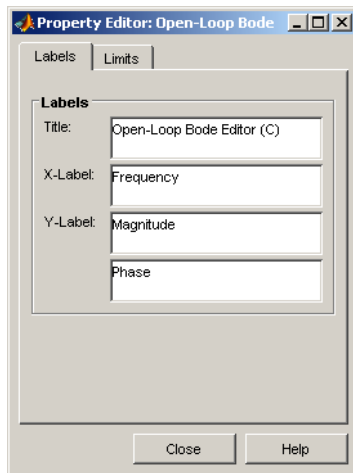

- “Labels Pane” on page 8-42
- “Limits Pane” on page 8-43

Labels Pane

You can use the **Label** pane to specify plot titles and axis labels. To specify a new label, type the string in the appropriate field. The Bode diagram automatically updates.

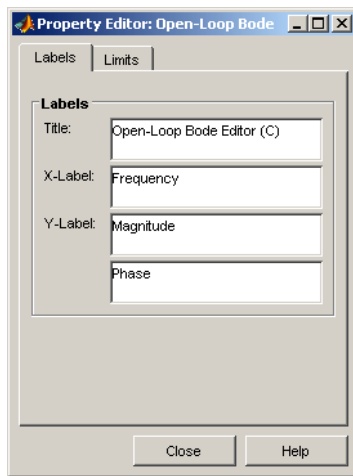

Limits Pane

You can use the Limits pane to override the default limits for the frequency, magnitude, and phase scales for your plots.

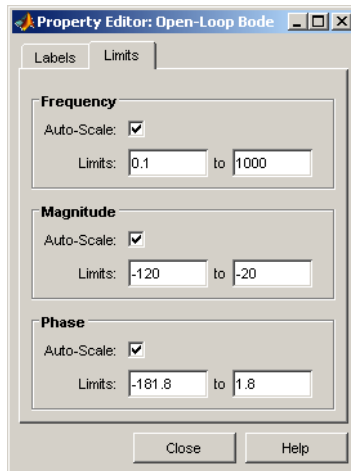

To change the limits, specify the new values in the **Limits** fields for frequency, magnitude, and phase. The **Auto-Scale** check box automatically deactivates once you click in a different field. The Bode diagram updates immediately.

To restore the default settings, select the **Auto-Scale** boxes again.

Open-Loop Nichols Property Editor

As is the case with the root locus Property Editor, there are three ways to open the Nichols plot property editor:

- Double-click in the Nichols plot away from the curve.
- Select **Properties** from the right-click menu.
- Select **Open-Loop Nichols** and then **Properties** from **Edit** in the menu bar.

This figure shows the **Property Editor: Open-Loop Nichols** editor.

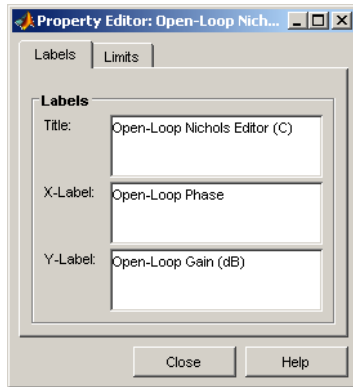

- “Labels Pane” on page 8-44
- “Limits Pane” on page 8-44

Labels Pane

You can use the Label pane to specify plot titles and axis labels. To specify a new label, type the string in the appropriate field. The Nichols plot automatically updates.

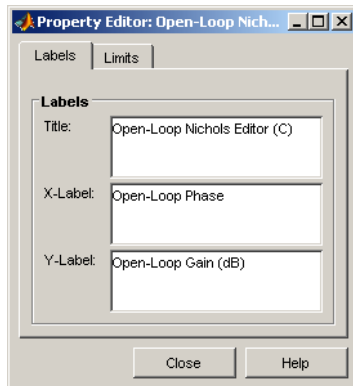

Limits Pane

You can use the Limits pane to override the default limits for the frequency, magnitude, and phase scales for your plots.

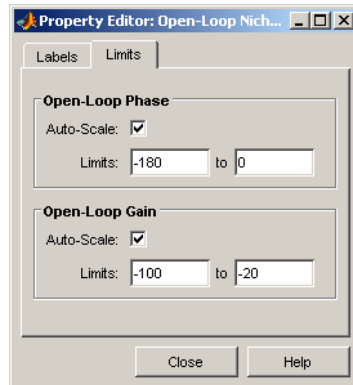

To change the limits, specify the new values in the **Limits** fields for open-loop phase and/or gain. The **Auto-Scale** check box automatically deactivates once you click in a different field. The Nichols plot updates immediately.

To restore the default settings, select the **Auto-Scale** boxes again.

Prefilter Bode Property Editor

The **Prefilter Bode Property** editor is identical to the Open-Loop Bode diagram property editor. There are three ways to open the prefilter editor:

- Double-click in the prefilter Bode magnitude or phase plot away from the curve.
- Select **Properties** from the right-click menu.
- Select **Prefilter Bode** and then **Properties** from **Edit** in the menu bar.

See “Open-Loop Bode Property Editor” on page 8-41 for a description of the features of this editor.

Design Case Studies

- “Yaw Damper for a 747 Jet Transport” on page 9-2
- “Hard-Disk Read/Write Head Controller” on page 9-19
- “LQG Regulation: Rolling Mill Example” on page 9-30
- “Kalman Filtering” on page 9-49

Yaw Damper for a 747 Jet Transport

In this section...

“Overview of this Case Study” on page 9-2

“Creating the Jet Model” on page 9-2

“Computing Open-Loop Eigenvalues” on page 9-4

“Open-Loop Analysis” on page 9-5

“Root Locus Design” on page 9-8

“Washout Filter Design” on page 9-13

Overview of this Case Study

This case study demonstrates the tools for classical control design by stepping through the design of a yaw damper for a 747[®] jet transport aircraft.

Creating the Jet Model

The jet model during cruise flight at MACH = 0.8 and H = 40,000 ft. is

$$A = \begin{bmatrix} -0.0558 & -0.9968 & 0.0802 & 0.0415 \\ 0.5980 & -0.1150 & -0.0318 & 0 \\ -3.0500 & 0.3880 & -0.4650 & 0 \\ 0 & 0.0805 & 1.0000 & 0 \end{bmatrix};$$

$$B = \begin{bmatrix} 0.0729 & 0.0000 \\ -4.7500 & 0.00775 \\ .15300 & 0.1430 \\ 0 & 0 \end{bmatrix};$$

$$C = \begin{bmatrix} 0 & 1 & 0 & 0 \\ 0 & 0 & 0 & 1 \end{bmatrix};$$

$$D = \begin{bmatrix} 0 & 0 \\ 0 & 0 \end{bmatrix};$$

The following commands specify this state-space model as an LTI object and attach names to the states, inputs, and outputs.

```

states = {'beta' 'yaw' 'roll' 'phi'};
inputs = {'rudder' 'aileron'};
outputs = {'yaw' 'bank angle'};

sys = ss(A,B,C,D,'statename',states,...
         'inputname',inputs,...
         'outputname',outputs);

```

You can display the LTI model `sys` by typing `sys`. This command produces the following result.

```

a =
           beta      yaw      roll      phi
beta  -0.0558  -0.9968  0.0802  0.0415
yaw   0.598    -0.115  -0.0318  0
roll  -3.05    0.388   -0.465  0
phi   0         0.0805  1        0

b =
           rudder      aileron
beta  0.0729  0
yaw   -4.75   0.00775
roll  0.153   0.143
phi   0       0

c =
           beta      yaw      roll      phi
yaw      0         1        0        0
bank angle 0         0        0        1

d =
           rudder      aileron
yaw      0         0
bank angle 0         0

```

Continuous-time model.

The model has two inputs and two outputs. The units are radians for beta (sideslip angle) and phi (bank angle) and radians/sec for yaw (yaw rate) and roll (roll rate). The rudder and aileron deflections are in radians as well.

Computing Open-Loop Eigenvalues

Compute the open-loop eigenvalues and plot them in the *s*-plane.

```
damp(sys)
```

Eigenvalue	Damping	Freq. (rad/s)
-7.28e-003	1.00e+000	7.28e-003
-5.63e-001	1.00e+000	5.63e-001
-3.29e-002 + 9.47e-001i	3.48e-002	9.47e-001
-3.29e-002 - 9.47e-001i	3.48e-002	9.47e-001

```
pzmap(sys)
```

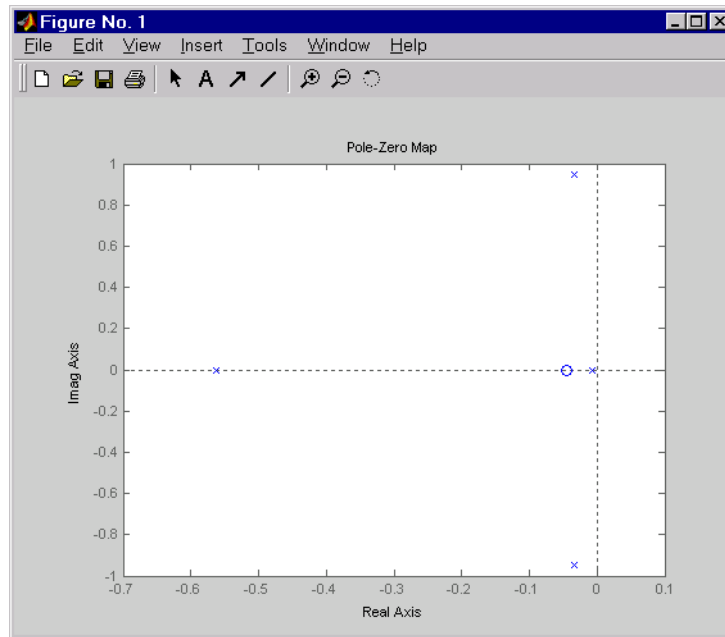

This model has one pair of lightly damped poles. They correspond to what is called the "Dutch roll mode."

Suppose you want to design a compensator that increases the damping of these poles, so that the resulting complex poles have a damping ratio $\zeta > 0.35$ with natural frequency $\omega_n < 1$ rad/sec. You can do this using the Control System Toolbox analysis tools.

Open-Loop Analysis

First, perform some open-loop analysis to determine possible control strategies. Start with the time response (you could use `step` or `impulse` here).

```
impulse(sys)
```

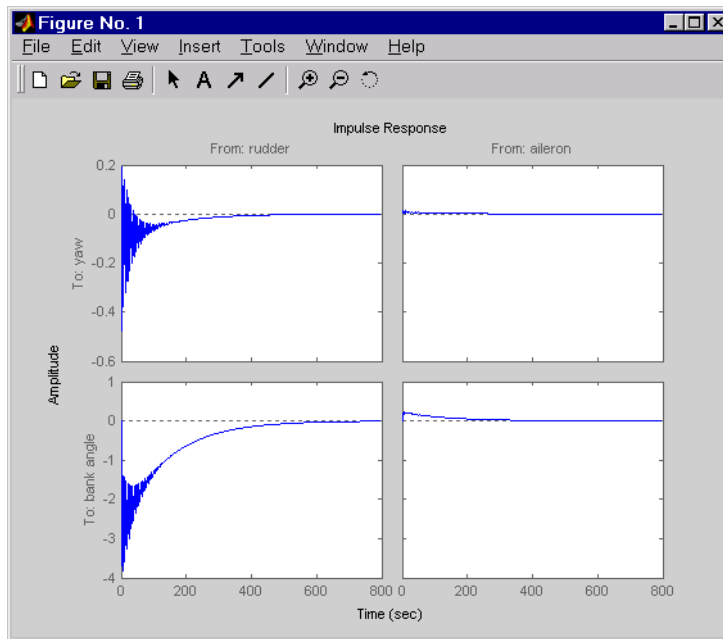

The impulse response confirms that the system is lightly damped. But the time frame is much too long because the passengers and the pilot are more concerned about the behavior during the first few seconds rather than the

first few minutes. Next look at the response over a smaller time frame of 20 seconds.

```
impulse(sys,20)
```

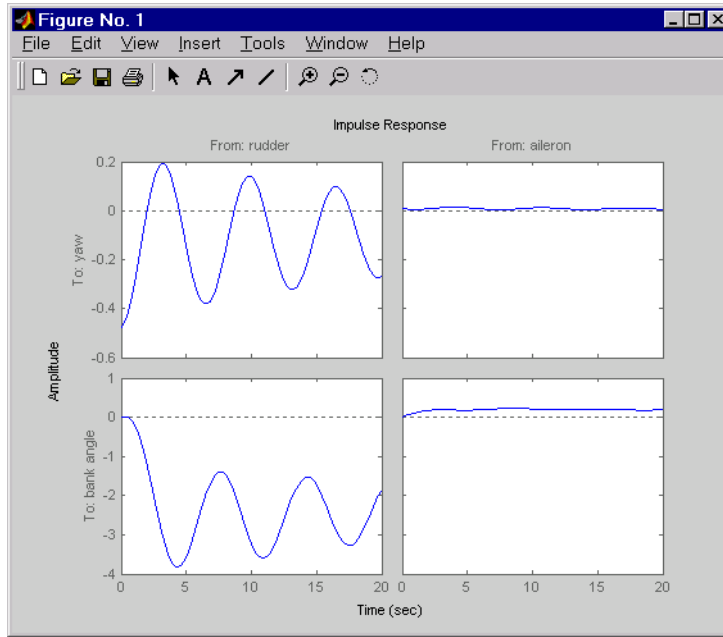

Look at the plot from aileron (input 2) to bank angle (output 2). To show only this plot, right-click and choose **I/O Selector**, then click on the (2,2) entry. The I/O Selector should look like this.



The new figure is shown below.

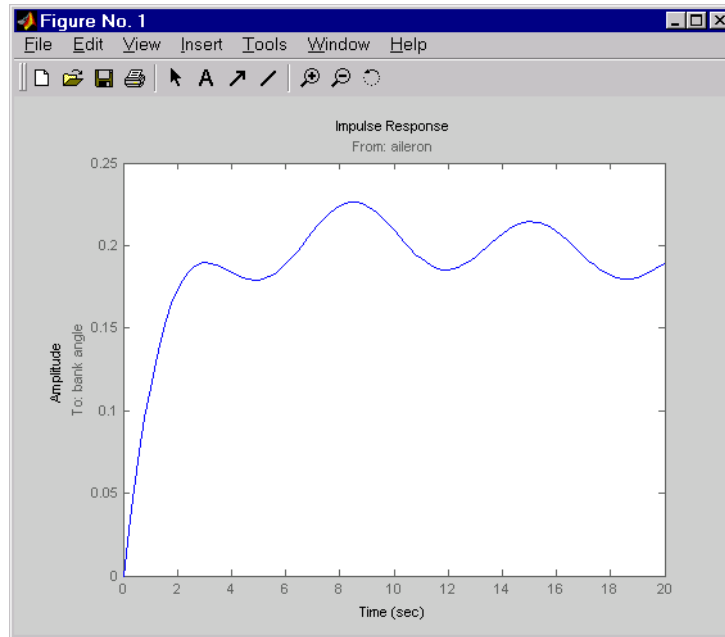

The aircraft is oscillating around a nonzero bank angle. Thus, the aircraft is turning in response to an aileron impulse. This behavior will prove important later in this case study.

Typically, yaw dampers are designed using the yaw rate as sensed output and the rudder as control input. Look at the corresponding frequency response.

```
sys11=sys('yaw','rudder') % Select I/O pair.  
bode(sys11)
```

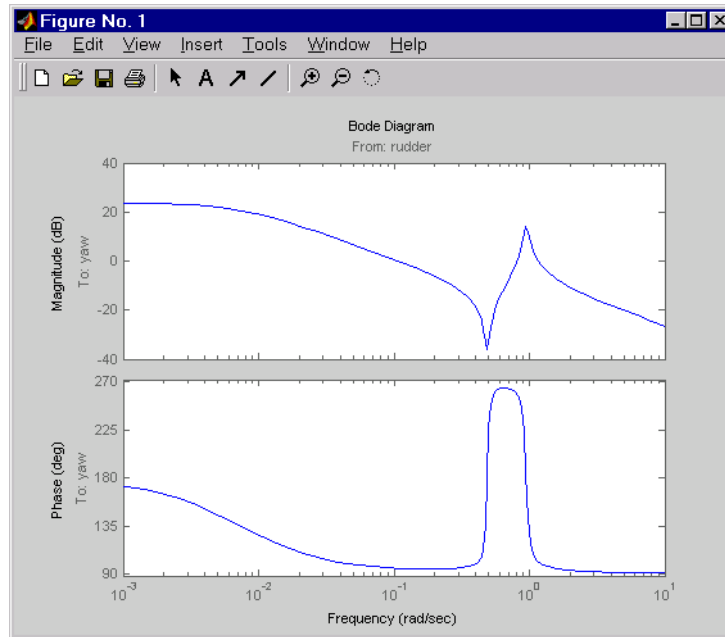

From this Bode diagram, you can see that the rudder has significant effect around the lightly damped Dutch roll mode (that is, near $\omega = 1$ rad/sec).

Root Locus Design

A reasonable design objective is to provide a damping ratio $\zeta > 0.35$ with a natural frequency $\omega_n < 1.0$ rad/sec. Since the simplest compensator is a static gain, first try to determine appropriate gain values using the root locus technique.

```
% Plot the root locus for the rudder to yaw channel
rlocus(sys11)
```

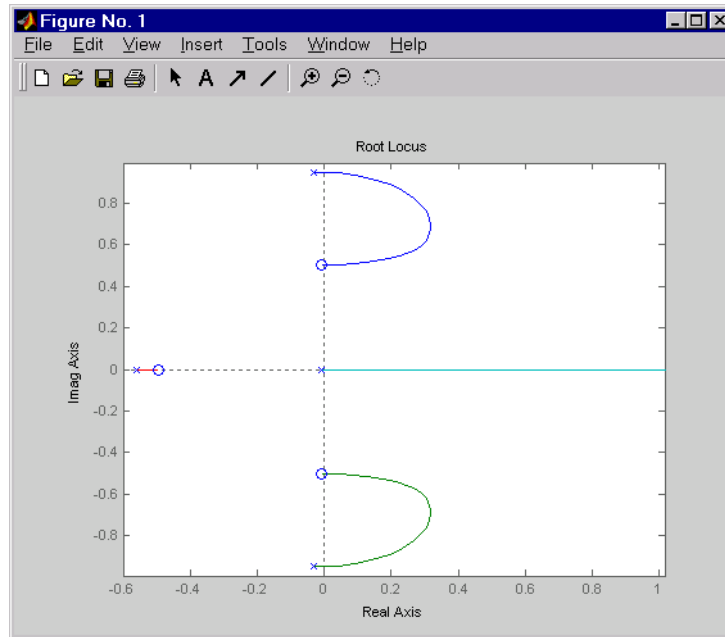

This is the root locus for negative feedback and shows that the system goes unstable almost immediately. If, instead, you use positive feedback, you may be able to keep the system stable.

```
rlocus(-sys11)  
sgrid
```

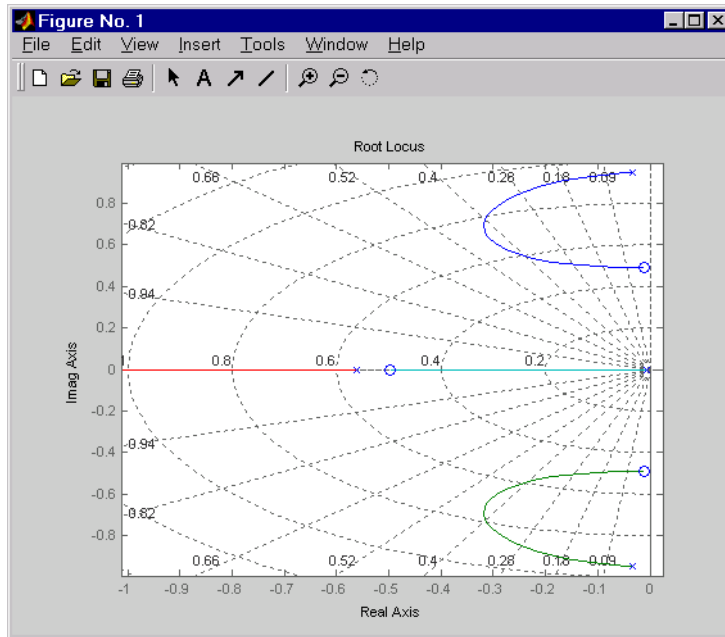

This looks better. By using simple feedback, you can achieve a damping ratio of $\zeta = 0.45$. Click on the blue curve and move the data marker to track the gain and damping values. To achieve a 0.45 damping ratio, the gain should be about 2.85. This figure shows the data marker with similar values.

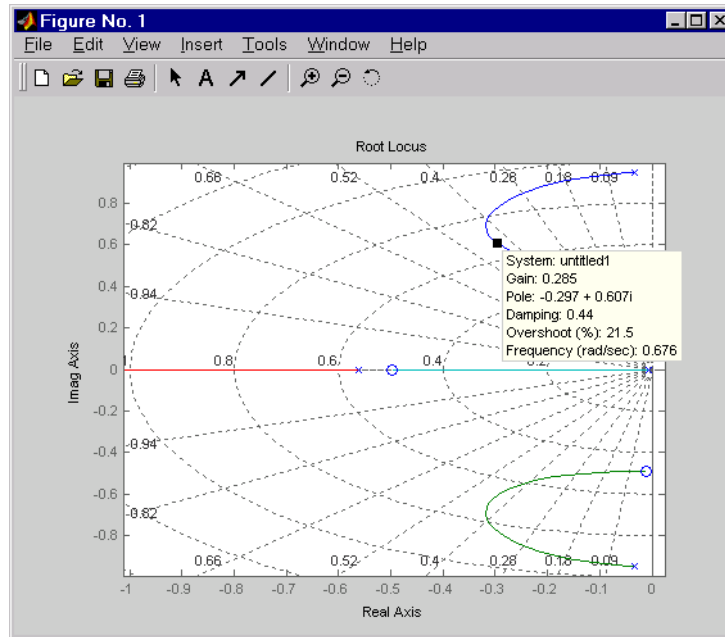

Next, close the SISO feedback loop.

```
K = 2.85;
c111 = feedback(sys11,-K); % Note: feedback assumes negative
                           % feedback by default
```

Plot the closed-loop impulse response for a duration of 20 seconds, and compare it to the open-loop impulse response.

```
impulse(sys11,'b--',c111,'r',20)
```

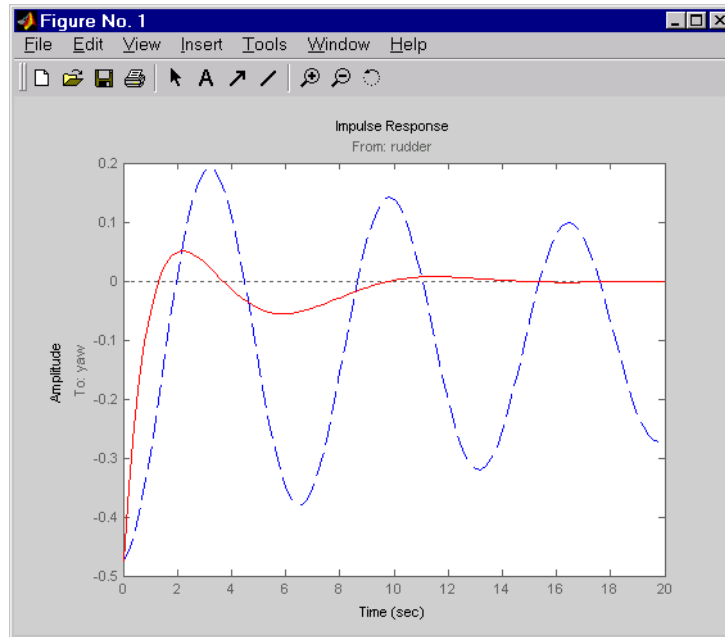

The closed-loop response settles quickly and does not oscillate much, particularly when compared to the open-loop response.

Now close the loop on the full MIMO model and see how the response from the aileron looks. The feedback loop involves input 1 and output 1 of the plant (use feedback with index vectors selecting this input/output pair). At the MATLAB prompt, type

```
cloop = feedback(sys, -K, 1, 1);
damp(cloop) % closed-loop poles
```

Eigenvalue	Damping	Freq. (rad/s)
-3.42e-001	1.00e+000	3.42e-001
-2.97e-001 + 6.06e-001i	4.40e-001	6.75e-001
-2.97e-001 - 6.06e-001i	4.40e-001	6.75e-001
-1.05e+000	1.00e+000	1.05e+000

Plot the MIMO impulse response.

```
impz(sys, 'b--', cloop, 'r', 20)
```

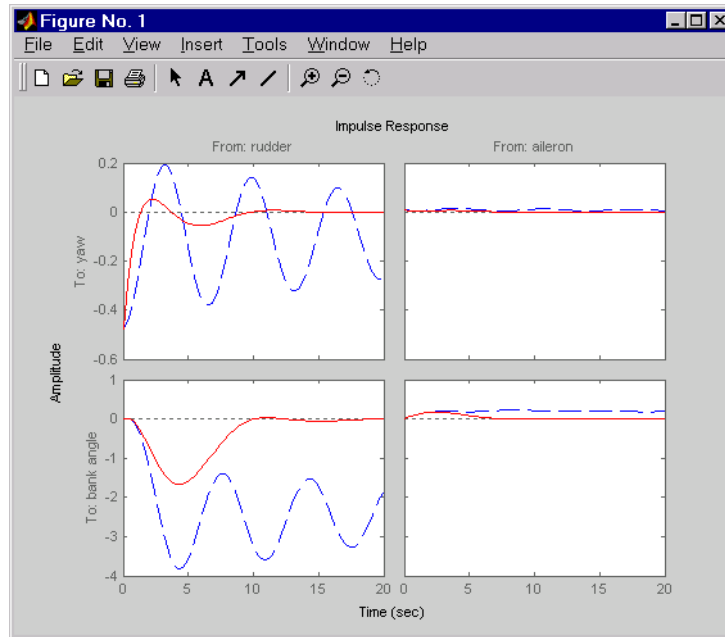

The yaw rate response is now well damped, but look at the plot from aileron (input 2) to bank angle (output 2). When you move the aileron, the system no longer continues to bank like a normal aircraft. You have over-stabilized the spiral mode. The spiral mode is typically a very slow mode and allows the aircraft to bank and turn without constant aileron input. Pilots are used to this behavior and will not like your design if it does not allow them to fly normally. This design has moved the spiral mode so that it has a faster frequency.

Washout Filter Design

What you need to do is make sure the spiral mode does not move further into the left-half plane when you close the loop. One way flight control designers have addressed this problem is to use a washout filter $kH(s)$ where

$$H(s) = \frac{s}{s + a}$$

The washout filter places a zero at the origin, which constrains the spiral mode pole to remain near the origin. We choose $\alpha = 0.2$ for a time constant of five seconds and use the root locus technique to select the filter gain H. First specify the fixed part $s/(s + \alpha)$ of the washout by

```
H = zpk(0, -0.2, 1);
```

Connect the washout in series with the design model sys11 (relation between input 1 and output 1) to obtain the open-loop model

```
olloop = H * sys11;
```

and draw another root locus for this open-loop model.

```
rlocus(-olloop)
sgrid
```

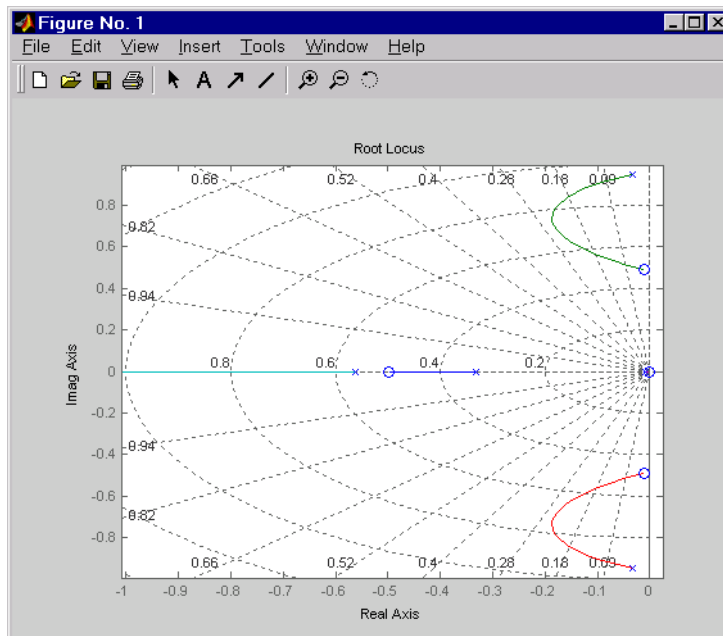

Create and drag a data marker around the upper curve to locate the maximum damping, which is about $\zeta = 0.3$.

This figure shows a data marker at the maximum damping ratio; the gain is approximately 2.07.

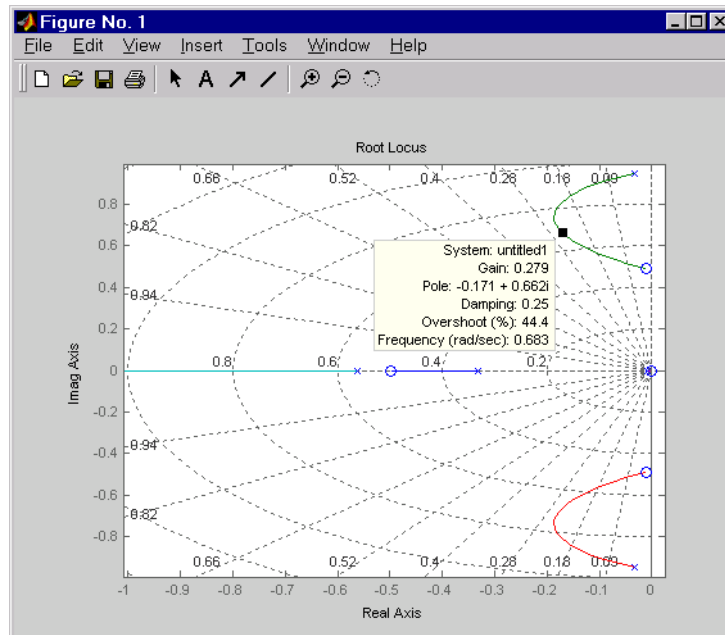

Look at the closed-loop response from rudder to yaw rate.

```
K = 2.07;
c111 = feedback(olloop, -K);
impulse(c111, 20)
```

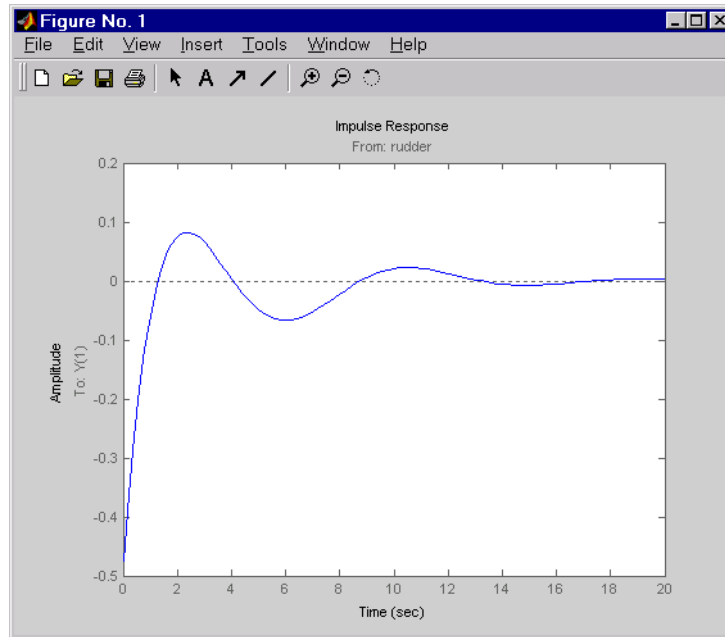

The response settles nicely but has less damping than your previous design. Finally, you can verify that the washout filter has fixed the spiral mode problem. First form the complete washout filter $kH(s)$ (washout + gain).

$$\text{WOF} = -K * H;$$

Then close the loop around the first I/O pair of the MIMO model `sys` and simulate the impulse response.

```
cloop = feedback(sys,WOF,1,1);

% Final closed-loop impulse response
impulse(sys,'b--',cloop,'r',20)
```

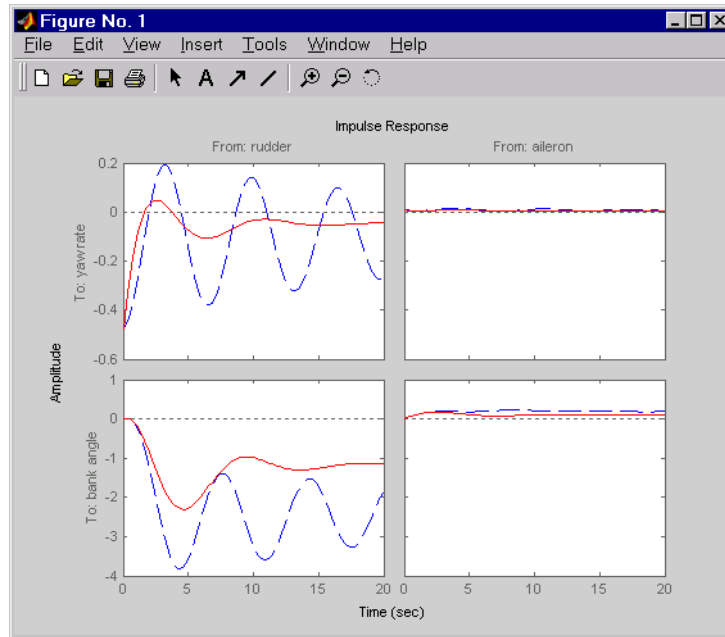

The bank angle response (output 2) due to an aileron impulse (input 2) now has the desired nearly constant behavior over this short time frame. To inspect the response more closely, use the I/O Selector in the right-click menu to select the (2,2) I/O pair.

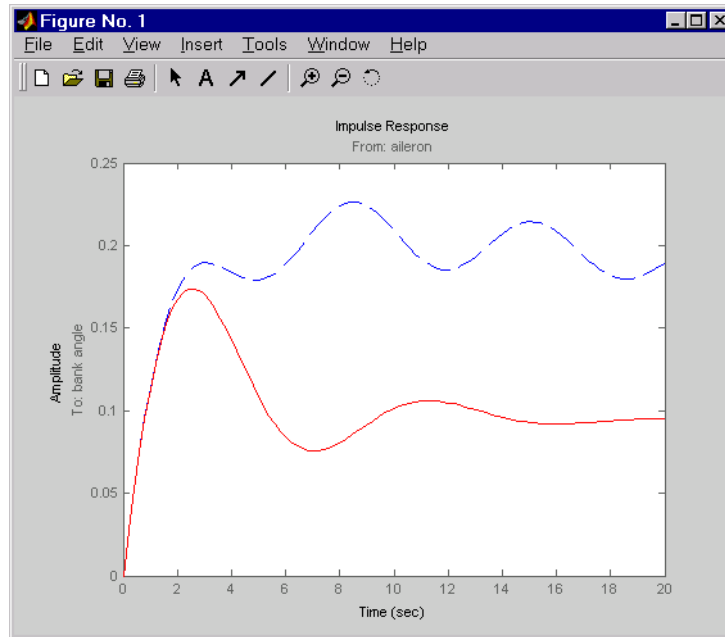

Although you did not quite meet the damping specification, your design has increased the damping of the system substantially and now allows the pilot to fly the aircraft normally.

Hard-Disk Read/Write Head Controller

In this section...

“Overview of this Case Study” on page 9-19

“Creating the Read/Write Head Model” on page 9-19

“Model Discretization” on page 9-20

“Adding a Compensator Gain” on page 9-22

“Adding a Lead Network” on page 9-23

“Design Analysis” on page 9-26

Overview of this Case Study

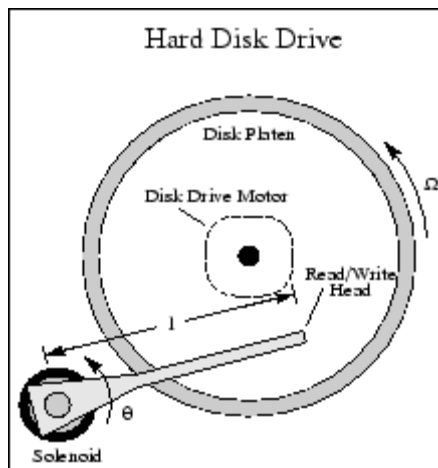

This case study demonstrates the ability to perform classical digital control design by going through the design of a computer hard-disk read/write head position controller.

Creating the Read/Write Head Model

Using Newton's law, a simple model for the read/write head is the differential equation

$$J \frac{d^2 \theta}{dt^2} + C \frac{d\theta}{dt} + K\theta = K_i i$$

where J is the inertia of the head assembly, C is the viscous damping coefficient of the bearings, K is the return spring constant, K_i is the motor torque constant, θ is the angular position of the head, and i is the input current.

Taking the Laplace transform, the transfer function from i to θ is

$$H(s) = \frac{K_i}{Js^2 + Cs + K}$$

Using the values $J = 0.01 \text{ kg m}^2$, $C = 0.004 \text{ Nm/(rad/sec)}$, $K = 10 \text{ Nm/rad}$, and $K_i = 0.05 \text{ Nm/rad}$, form the transfer function description of this system. At the MATLAB prompt, type

```
J = .01; C = 0.004; K = 10; Ki = .05;
num = Ki;
den = [J C K];
H = tf(num,den)
```

These commands produce the following result.

```
Transfer function:
      0.05
-----
0.01 s^2 + 0.004 s + 10
```

Model Discretization

The task here is to design a digital controller that provides accurate positioning of the read/write head. The design is performed in the digital domain. First, discretize the continuous plant. Because our plant will be equipped with a digital-to-analog converter (with a zero-order hold) connected to its input, use `c2d` with the 'zoh' discretization method. Type

```
Ts = 0.005;      % sampling period = 0.005 second
Hd = c2d(H,Ts,'zoh')
Transfer function:
```

$$\frac{6.233e-05 z + 6.229e-05}{z^2 - 1.973 z + 0.998}$$

Sampling time: 0.005

You can compare the Bode plots of the continuous and discretized models with

`bode(H, '-', Hd, '- -')`

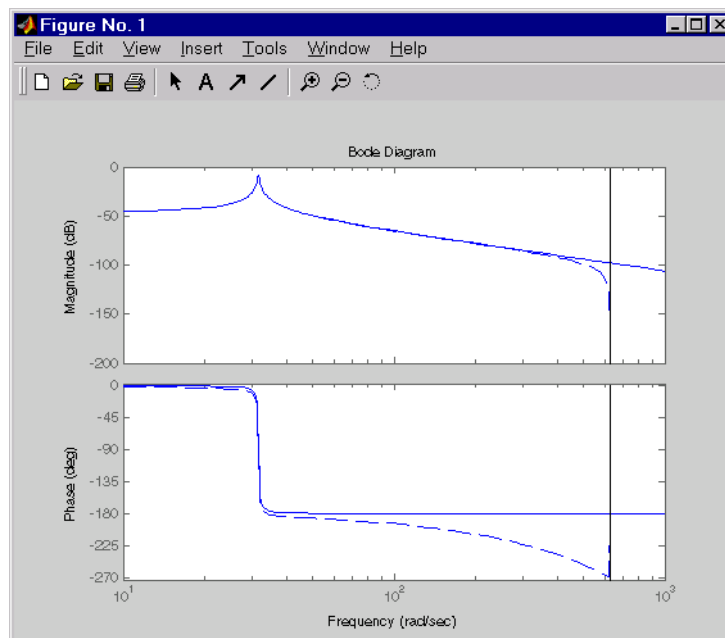

To analyze the discrete system, plot its step response, type

`step(Hd)`

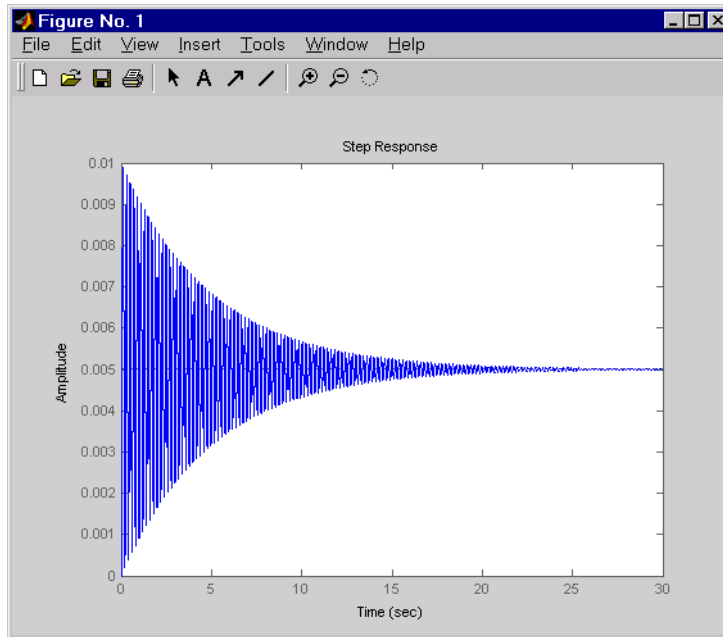

The system oscillates quite a bit. This is probably due to very light damping. You can check this by computing the open-loop poles. Type

```
% Open-loop poles of discrete model
damp(Hd)
      Eigenvalue      Magnitude      Equiv. Damping      Equiv. Freq.
      9.87e-01 + 1.57e-01i      9.99e-01      6.32e-03      3.16e+01
      9.87e-01 - 1.57e-01i      9.99e-01      6.32e-03      3.16e+01
```

The poles have very light equivalent damping and are near the unit circle. You need to design a compensator that increases the damping of these poles.

Adding a Compensator Gain

The simplest compensator is just a gain, so try the root locus technique to select an appropriate feedback gain.

```
rlocus(Hd)
```

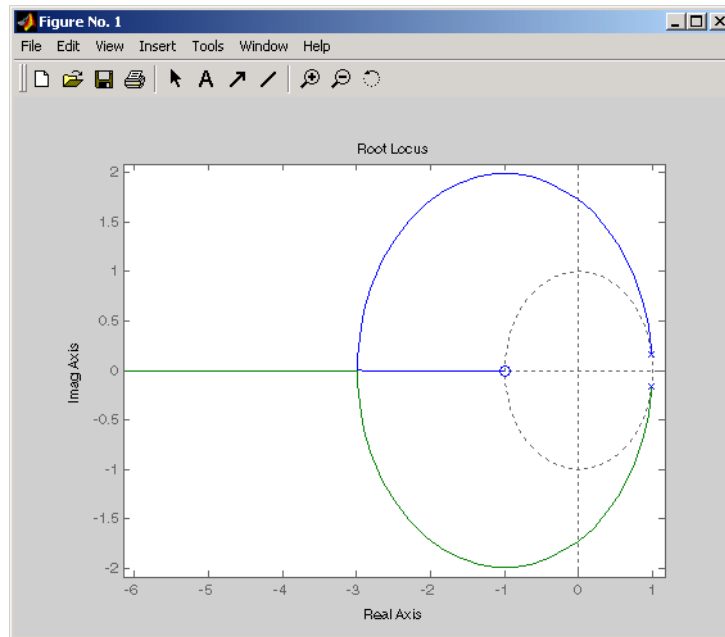

As shown in the root locus, the poles quickly leave the unit circle and go unstable. You need to introduce some lead or a compensator with some zeros.

Adding a Lead Network

Try the compensator

$$D(z) = \frac{z + a}{z + b}$$

with $a = -0.85$ and $b = 0$.

The corresponding open-loop model

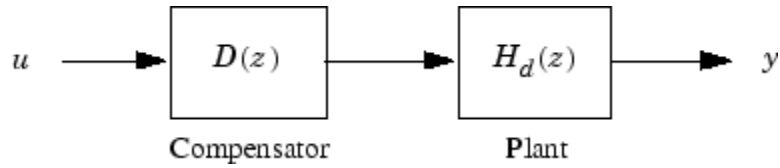

is obtained by the series connection

```

D = zpk(0.85,0,1,Ts)
oloop = Hd * D
  
```

Now see how this compensator modifies the open-loop frequency response.

```

bode(Hd, '-', oloop, '-')
  
```

The plant response is the dashed line and the open-loop response with the compensator is the solid line.

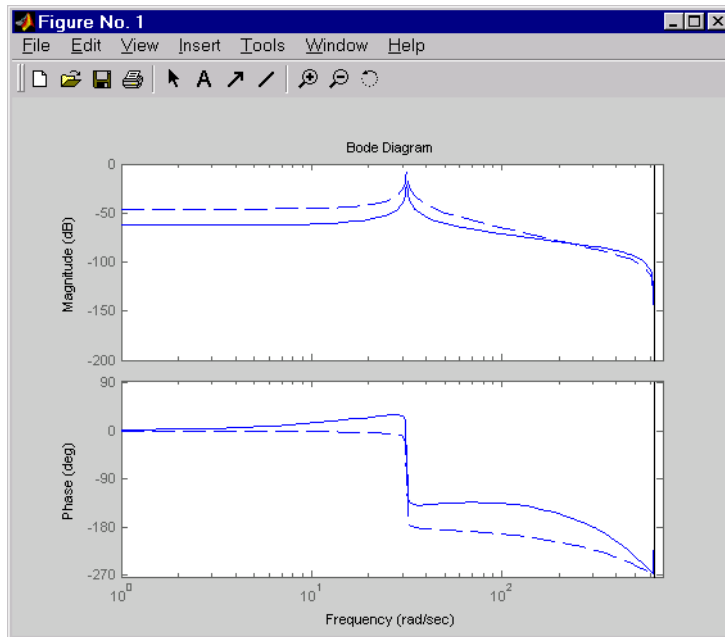

The plot above shows that the compensator has shifted up the phase plot (added lead) in the frequency range $\omega > 10$ rad/sec.

Now try the root locus again with the plant and compensator as open loop.

```
rlocus(olloop)
zgrid
```

Open the **Property Editor** by right-clicking in the plot away from the curve. On the **Limits** page, set the x - and y -axis limits from -1 to 1.01. This figure shows the result.

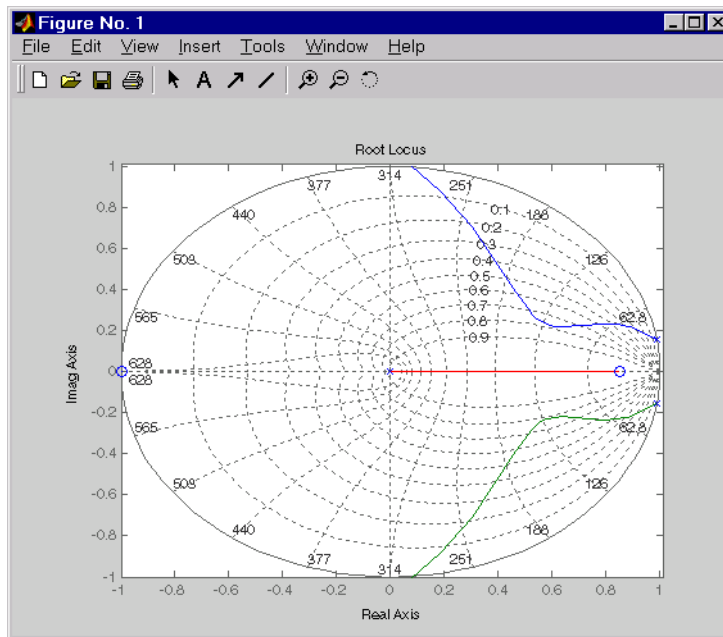

This time, the poles stay within the unit circle for some time (the lines drawn by `zgrid` show the damping ratios from $\zeta = 0$ to 1 in steps of 0.1). Use a data marker to find the point on the curve where the gain equals $4.111e+03$. This figure shows the data marker at the correct location.

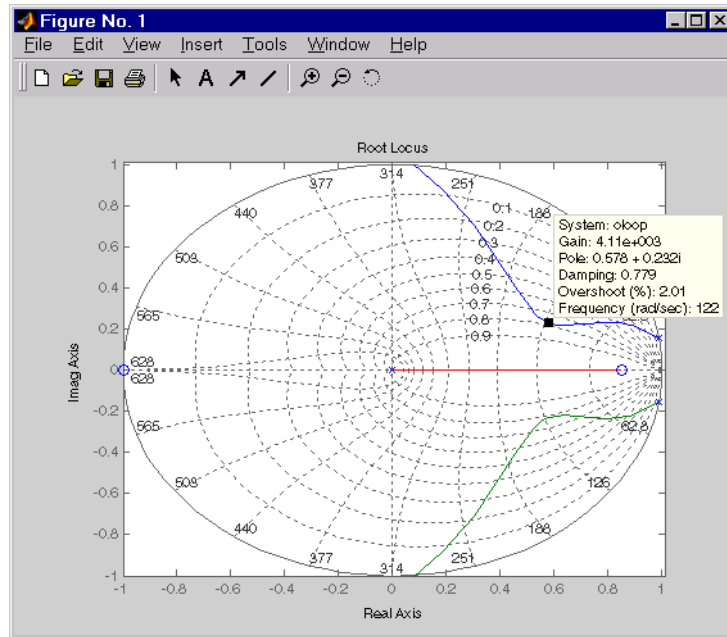

Design Analysis

To analyze this design, form the closed-loop system and plot the closed-loop step response.

```
K = 4.11e+03;
cloop = feedback(olloop,K);
step(cloop)
```

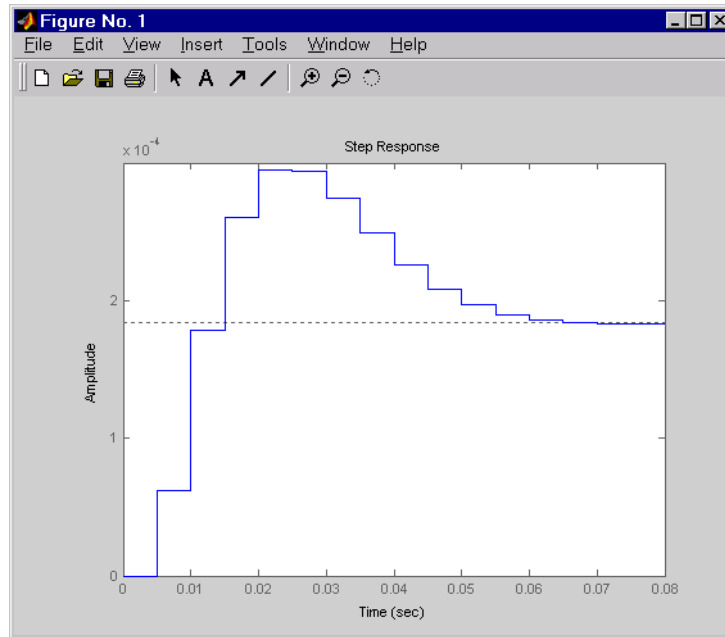



This response depends on your closed loop set point. The one shown here is relatively fast and settles in about 0.07 seconds. Therefore, this closed loop disk drive system has a seek time of about 0.07 seconds. This is slow by today's standards, but you also started with a very lightly damped system.

Now look at the robustness of your design. The most common classical robustness criteria are the gain and phase margins. Use the function `margin` to determine these margins. With output arguments, `margin` returns the gain and phase margins as well as the corresponding crossover frequencies. Without output argument, `margin` plots the Bode response and displays the margins graphically.

To compute the margins, first form the unity-feedback open loop by connecting the compensator $D(z)$, plant model, and feedback gain k in series.

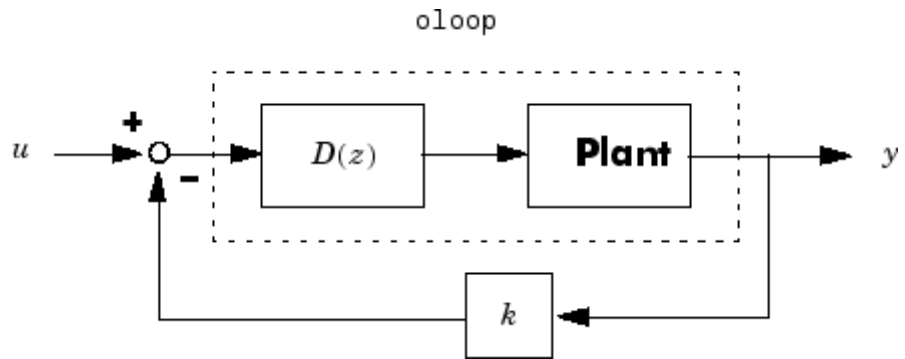
```
olk = K * oloop;
```



Next apply margin to this open-loop model. Type

```
[Gm,Pm,Wcg,Wcp] = margin(olk);
Margins = [Gm Wcg Pm Wcp]
Margins =

    3.7987   296.7978   43.2031   106.2462
```

To obtain the gain margin in dB, type

```
20*log10(Gm)
ans =

    11.5926
```

You can also display the margins graphically by typing

```
margin(olk)
```

The command produces the plot shown below.

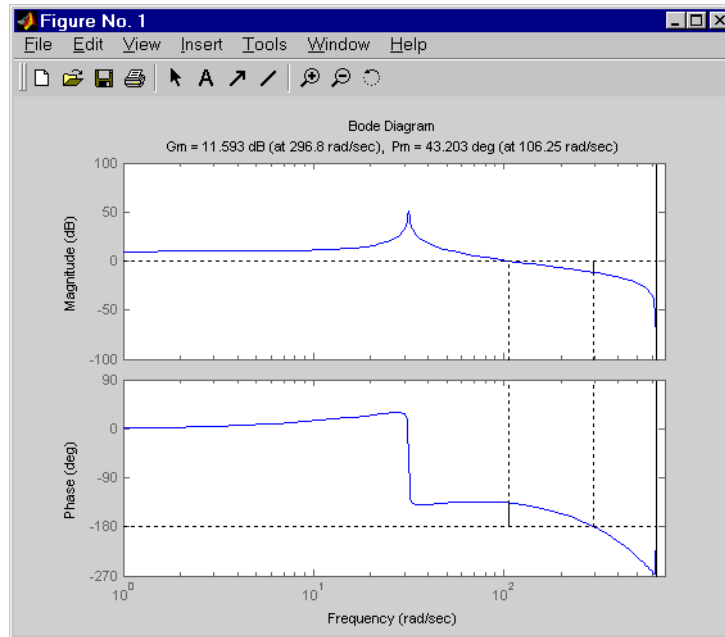

This design is robust and can tolerate a 11 dB gain increase or a 40 degree phase lag in the open-loop system without going unstable. By continuing this design process, you may be able to find a compensator that stabilizes the open-loop system and allows you to reduce the seek time.

LQG Regulation: Rolling Mill Example

In this section...
“Overview of this Case Study” on page 9-30
“Process and Disturbance Models” on page 9-30
“LQG Design for the x-Axis” on page 9-34
“LQG Design for the y-Axis” on page 9-40
“Cross-Coupling Between Axes” on page 9-42
“MIMO LQG Design” on page 9-45

Overview of this Case Study

This case study demonstrates the use of the LQG design tools in a process control application. The goal is to regulate the horizontal and vertical thickness of the beam produced by a hot steel rolling mill. This example is adapted from [1]. The full plant model is MIMO and the example shows the advantage of direct MIMO LQG design over separate SISO designs for each axis. Type

```
milldemo
```

at the command line to run this demonstration interactively.

Process and Disturbance Models

The rolling mill is used to shape rectangular beams of hot metal. The desired outgoing shape is sketched below.

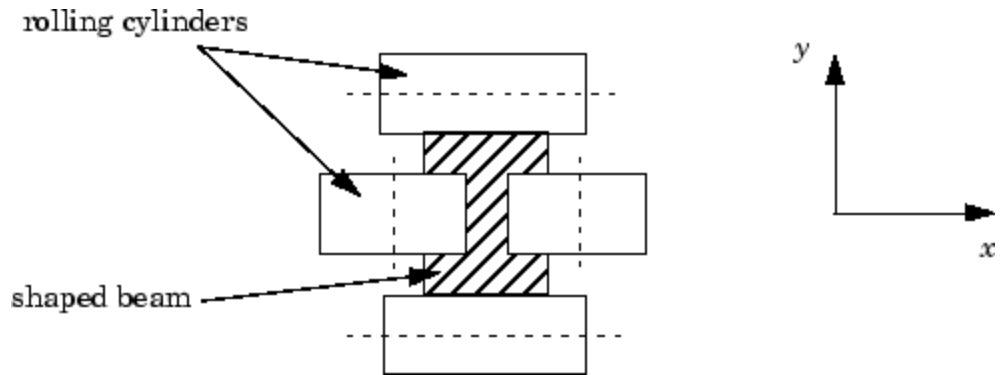

This shape is impressed by two pairs of rolling cylinders (one per axis) positioned by hydraulic actuators. The gap between the two cylinders is called the *roll gap*.

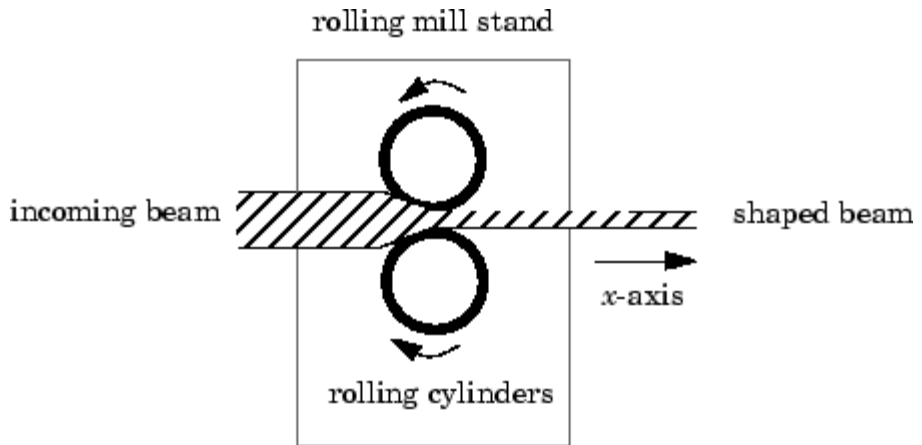

The objective is to maintain the beam thickness along the x - and y -axes within the quality assurance tolerances. Variations in output thickness can arise from the following:

- Variations in the thickness/hardness of the incoming beam
- Eccentricity in the rolling cylinders

Feedback control is necessary to reduce the effect of these disturbances. Because the roll gap cannot be measured close to the mill stand, the rolling force is used instead for feedback.

The input thickness disturbance is modeled as a low pass filter driven by white noise. The eccentricity disturbance is approximately periodic and its frequency is a function of the rolling speed. A reasonable model for this disturbance is a second-order bandpass filter driven by white noise.

This leads to the following generic model for each axis of the rolling process.

Open-loop Model for x- or y-axis

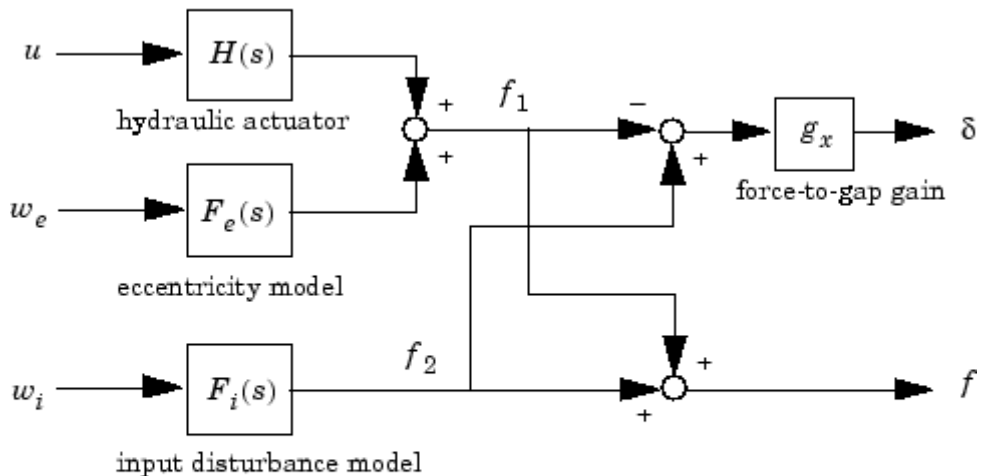

- u **command**
- δ **thickness gap (in mm)**
- f **incremental rolling force**
- w_i, w_e **driving white noise for disturbance models**

The measured rolling force variation f is a combination of the incremental force delivered by the hydraulic actuator and of the disturbance forces due to eccentricity and input thickness variation. Note that:

- The outputs of $H(s)$, $F_e(s)$, and $F_i(s)$ are the incremental forces delivered by each component.
- An increase in hydraulic or eccentricity force *reduces* the output thickness gap δ .
- An increase in input thickness *increases* this gap.

The model data for each axis is summarized below.

Model Data for the x-Axis

$$H_x(s) = \frac{2.4 \times 10^8}{s^2 + 72s + 90^2}$$

$$F_{ix}(s) = \frac{10^4}{s + 0.05}$$

$$F_{ex}(s) = \frac{3 \times 10^4 s}{s^2 + 0.125s + 6^2}$$

$$g_x = 10^{-6}$$

Model Data for the y-Axis

$$H_y(s) = \frac{7.8 \times 10^8}{s^2 + 71s + 88^2}$$

$$F_{iy}(s) = \frac{2 \times 10^4}{s + 0.05}$$

$$F_{ey}(s) = \frac{10^5 s}{s^2 + 0.19s + 9.4^2}$$

$$g_y = 0.5 \times 10^{-6}$$

LQG Design for the x-Axis

As a first approximation, ignore the cross-coupling between the x - and y -axes and treat each axis independently. That is, design one SISO LQG regulator for each axis. The design objective is to reduce the thickness variations δ_x and δ_y due to eccentricity and input thickness disturbances.

Start with the x -axis. First specify the model components as transfer function objects.

```
% Hydraulic actuator (with input "u-x")
Hx = tf(2.4e8,[1 72 90^2],'inputname','u-x')

% Input thickness/hardness disturbance model
Fix = tf(1e4,[1 0.05],'inputn','w-ix')

% Rolling eccentricity model
Fex = tf([3e4 0],[1 0.125 6^2],'inputn','w-ex')

% Gain from force to thickness gap
gx = 1e-6;
```

Next build the open-loop model shown in “Process and Disturbance Models” on page 9-30. You could use the function `connect` for this purpose, but it is easier to build this model by elementary `append` and `series` connections.

```
% I/O map from inputs to forces f1 and f2
Px = append([ss(Hx) Fex],Fix)

% Add static gain from f1,f2 to outputs "x-gap" and "x-force"
Px = [-gx gx;1 1] * Px

% Give names to the outputs:
set(Px,'outputn',{'x-gap' 'x-force'})
```

Note To obtain minimal state-space realizations, always convert transfer function models to state space *before* connecting them. Combining transfer functions and then converting to state space may produce nonminimal state-space models.

The variable Px now contains an open-loop state-space model complete with input and output names.

```
Px.inputname
```

```
ans =
    'u-x'
    'w-ex'
    'w-ix'
```

```
Px.outputname
```

```
ans =
    'x-gap'
    'x-force'
```

The second output 'x-force' is the rolling force measurement. The LQG regulator will use this measurement to drive the hydraulic actuator and reduce disturbance-induced thickness variations δ_x .

The LQG design involves two steps:

- 1 Design a full-state-feedback gain that minimizes an LQ performance measure of the form

$$J(u_x) = \int_0^{\infty} \left\{ q \delta_x^2 + r u_x^2 \right\} dt$$

- 2 Design a Kalman filter that estimates the state vector given the force measurements 'x-force'.

The performance criterion $J(u_x)$ penalizes low and high frequencies equally. Because low-frequency variations are of primary concern, eliminate the high-frequency content of δ_x with the low-pass filter $30/(s + 30)$ and use the filtered value in the LQ performance criterion.

```
lpf = tf(30,[1 30])
```

```
% Connect low-pass filter to first output of Px
Pxdes = append(lpf,1) * Px
```

```
set(Pxdes, 'outputn', {'x-gap*' 'x-force'})  
  
% Design the state-feedback gain using LQRY and q=1, r=1e-4  
kx = lqry(Pxdes(1,1),1,1e-4)
```

Note `lqry` expects all inputs to be commands and all outputs to be measurements. Here the command 'u-x' and the measurement 'x-gap*' (filtered gap) are the first input and first output of `Pxdes`. Hence, use the syntax `Pxdes(1,1)` to specify just the I/O relation between 'u-x' and 'x-gap*'.

Next, design the Kalman estimator with the function `kalman`. The process noise

$$w_x = \begin{bmatrix} w_{ex} \\ w_{ix} \end{bmatrix}$$

has unit covariance by construction. Set the measurement noise covariance to 1000 to limit the high frequency gain, and keep only the measured output 'x-force' for estimator design.

```
estx = kalman(Pxdes(2,:), eye(2), 1000)
```

Finally, connect the state-feedback gain `kx` and state estimator `estx` to form the LQG regulator.

```
Regx = lqgreg(estx, kx)
```

This completes the LQG design for the x -axis.

Let's look at the regulator Bode response between 0.1 and 1000 rad/sec.

```
bode(Regx, {0.1 1000})
```

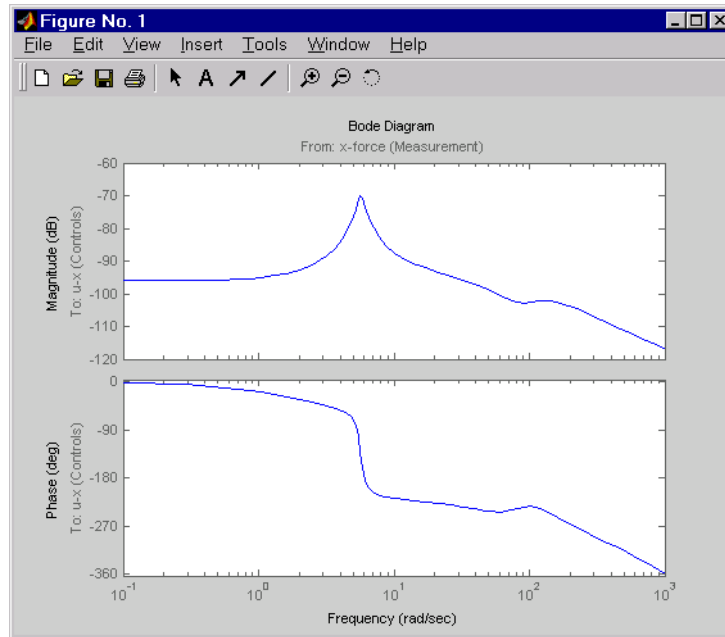

The phase response has an interesting physical interpretation. First, consider an increase in input thickness. This low-frequency disturbance boosts both output thickness and rolling force. Because the regulator phase is approximately 0° at low frequencies, the feedback loop then adequately reacts by increasing the hydraulic force to offset the thickness increase. Now consider the effect of eccentricity. Eccentricity causes fluctuations in the roll gap (gap between the rolling cylinders). When the roll gap is minimal, the rolling force increases and the beam thickness diminishes. The hydraulic force must then be reduced (negative force feedback) to restore the desired thickness. This is exactly what the LQG regulator does as its phase drops to -180° near the natural frequency of the eccentricity disturbance (6 rad/sec).

Next, compare the open- and closed-loop responses from disturbance to thickness gap. Use `feedback` to close the loop. To help specify the feedback connection, look at the I/O names of the plant `Px` and regulator `Regx`.

```
Px.inputname
ans =
    'u-x'
```

```

    'w-ex'
    'w-ix'

    Regx.outputname
    ans =
        'u-x'

    Px.outputname
    ans =
        'x-gap'
        'x-force'

    Regx.inputname
    ans =
        'x-force'

```

This indicates that you must connect the first input and second output of Px to the regulator.

```

    clx = feedback(Px,Regx,1,2,+1)    % Note: +1 for positive feedback

```

You are now ready to compare the open- and closed-loop Bode responses from disturbance to thickness gap.

```

    bode(Px(1,2:3), '--', clx(1,2:3), '- ', {0.1 100})

```

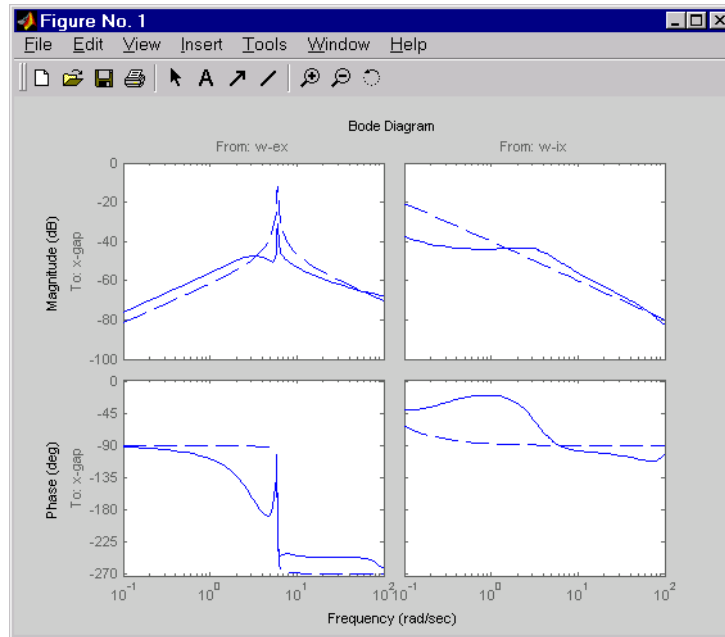

The dashed lines show the open-loop response. Note that the peak gain of the eccentricity-to-gap response and the low-frequency gain of the input-thickness-to-gap response have been reduced by about 20 dB.

Finally, use `lsim` to simulate the open- and closed-loop time responses to the white noise inputs w_{ex} and w_{ix} . Choose $dt=0.01$ as sampling period for the simulation, and derive equivalent discrete white noise inputs for this sampling rate.

```
dt = 0.01
t = 0:dt:50    % time samples

% Generate unit-covariance driving noise wx = [w-ex;w-ix].
% Equivalent discrete covariance is 1/dt
wx = sqrt(1/dt) * randn(2,length(t))

lsim(Px(1,2:3), ':', clx(1,2:3), '-', wx, t)
```

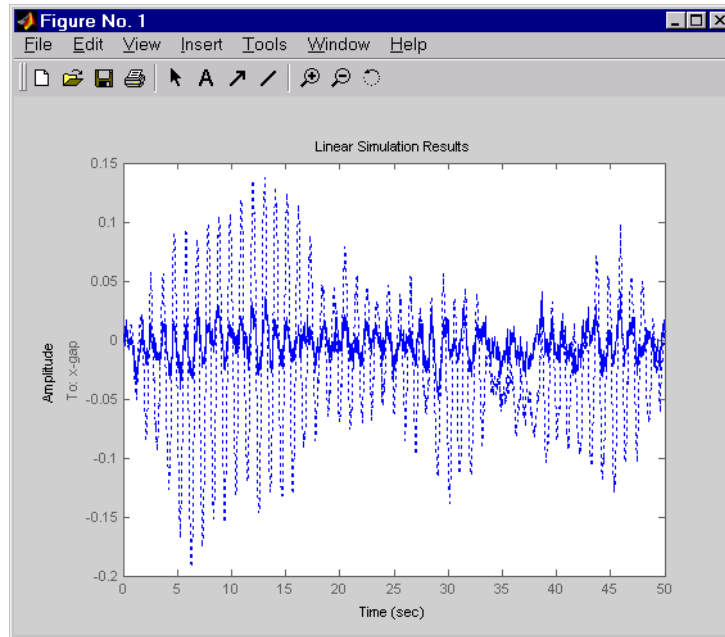

The dotted lines correspond to the open-loop response. In this simulation, the LQG regulation reduces the peak thickness variation by a factor 4.

LQG Design for the y -Axis

The LQG design for the y -axis (regulation of the y thickness) follows the exact same steps as for the x -axis.

```
% Specify model components
Hy = tf(7.8e8,[1 71 88^2],'inputn','u-y')
Fiy = tf(2e4,[1 0.05],'inputn','w-iy')
Fey = tf([1e5 0],[1 0.19 9.4^2],'inputn','w-ey')
gy = 0.5e-6 % force-to-gap gain

% Build open-loop model
Py = append([ss(Hy) Fey],Fiy)
Py = [-gy gy;1 1] * Py
set(Py,'outputn',{'y-gap' 'y-force'})
```

```
% State-feedback gain design
Pydes = append(lpf,1) * Py % Add low-freq. weighing
set(Pydes,'outputn',{ 'y-gap* ' 'y-force'})
ky = lqry(Pydes(1,1),1,1e-4)

% Kalman estimator design
esty = kalman(Pydes(2,:),eye(2),1e3)

% Form SISO LQG regulator for y-axis and close the loop
Regy = lqgreg(esty,ky)
cly = feedback(Py,Regy,1,2,+1)
```

Compare the open- and closed-loop response to the white noise input disturbances.

```
dt = 0.01
t = 0:dt:50
wy = sqrt(1/dt) * randn(2,length(t))

lsim(Py(1,2:3), ':', cly(1,2:3), '- ', wy, t)
```

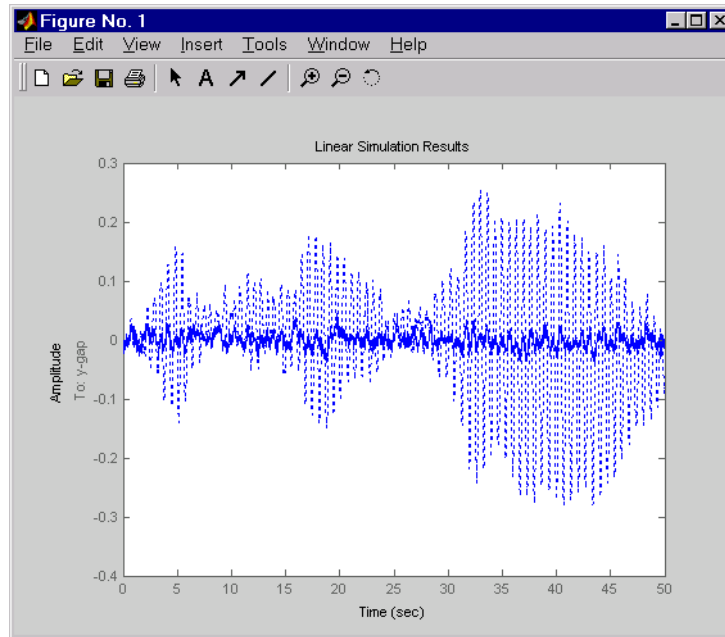

The dotted lines correspond to the open-loop response. The simulation results are comparable to those for the x -axis.

Cross-Coupling Between Axes

The x/y thickness regulation, is a MIMO problem. So far you have treated each axis separately and closed one SISO loop at a time. This design is valid as long as the two axes are fairly decoupled. Unfortunately, this rolling mill process exhibits some degree of cross-coupling between axes. Physically, an increase in hydraulic force along the x -axis compresses the material, which in turn boosts the repelling force on the y -axis cylinders. The result is an increase in y -thickness and an equivalent (relative) decrease in hydraulic force along the y -axis.

The figure below shows the coupling.

Coupling Between the x- and y-axes

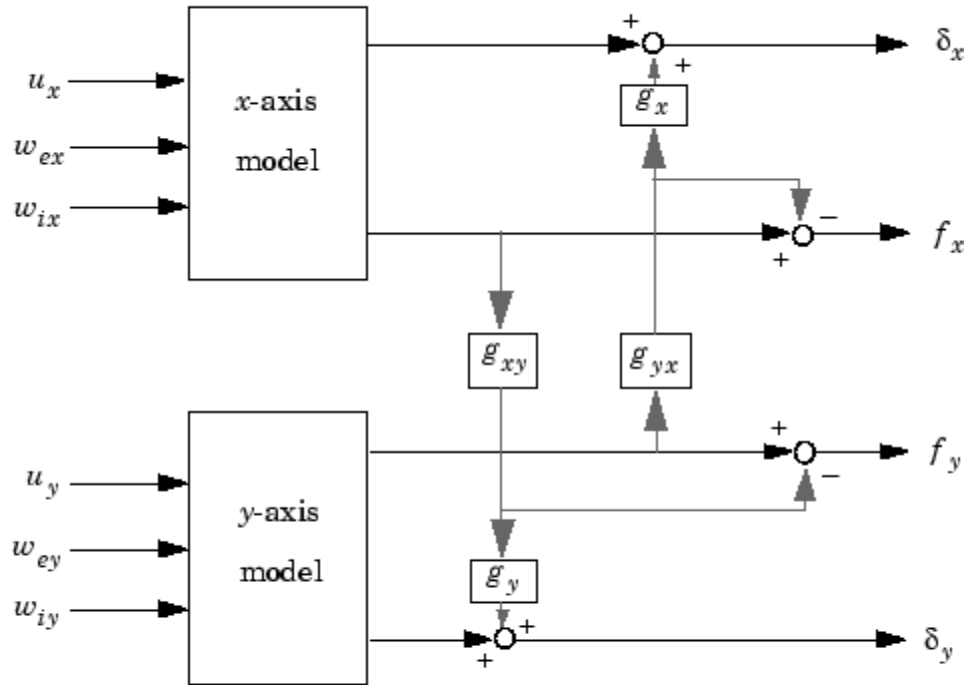

$$g_{xy} = 0.1$$

$$g_{yx} = 0.4$$

Accordingly, the thickness gaps and rolling forces are related to the outputs $\bar{\delta}_x, \bar{f}_x, \dots$ of the x - and y -axis models by

$$\begin{bmatrix} \delta_x \\ \delta_y \\ f_x \\ f_y \end{bmatrix} = \underbrace{\begin{bmatrix} 1 & 0 & 0 & g_{yx}g_x \\ 0 & 1 & g_{xy}g_y & 0 \\ 0 & 0 & 1 & -g_{yx} \\ 0 & 0 & -g_{xy} & 1 \end{bmatrix}}_{\text{cross-coupling matrix}} \begin{bmatrix} \bar{\delta}_x \\ \bar{\delta}_y \\ \bar{f}_x \\ \bar{f}_y \end{bmatrix}$$

Let's see how the previous "decoupled" LQG design fares when cross-coupling is taken into account. To build the two-axes model, shown above, append the models Px and Py for the x - and y -axes.

```
P = append(Px,Py)
```

For convenience, reorder the inputs and outputs so that the commands and thickness gaps appear first.

```
P = P([1 3 2 4],[1 4 2 3 5 6])
P.outputname

ans =
    'x-gap'
    'y-gap'
    'x-force'
    'y-force'
```

Finally, place the cross-coupling matrix in series with the outputs.

```
gxy = 0.1; gyx = 0.4;
CCmat = [eye(2) [0 gyx*gx;gxy*gy 0] ; zeros(2) [1 -gyx;-gxy 1]]
Pc = CCmat * P
Pc.outputname = P.outputname
```

To simulate the closed-loop response, also form the closed-loop model by

```
feedin = 1:2 % first two inputs of Pc are the commands
feedout = 3:4 % last two outputs of Pc are the measurements
cl = feedback(Pc,append(Regx,Regy),feedin,feedout,+1)
```

You are now ready to simulate the open- and closed-loop responses to the driving white noises w_x (for the x -axis) and w_y (for the y -axis).

```
wxy = [wx ; wy]
lsim(Pc(1:2,3:6), ':', cl(1:2,3:6), '- ', wxy, t)
```

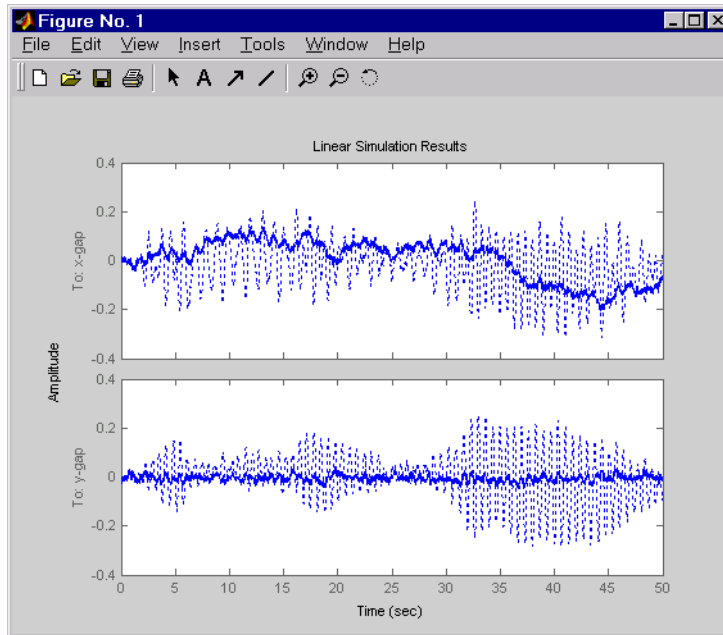

The response reveals a severe deterioration in regulation performance along the x -axis (the peak thickness variation is about four times larger than in the simulation without cross-coupling). Hence, designing for one loop at a time is inadequate for this level of cross-coupling, and you must perform a joint-axis MIMO design to correctly handle coupling effects.

MIMO LQG Design

Start with the complete two-axis state-panespace model P_c derived in “Cross-Coupling Between Axes” on page 9-42. The model inputs and outputs are

```
Pc.inputname
```

```
ans =  
    'u-x'  
    'u-y'  
    'w-ex'  
    'w-ix'  
    'w_ey'  
    'w_iy'
```

```
P.outputname
```

```
ans =  
    'x-gap'  
    'y-gap'  
    'x-force'  
    'y-force'
```

As earlier, add low-pass filters in series with the 'x-gap' and 'y-gap' outputs to penalize only low-frequency thickness variations.

```
Pdes = append(lpf,lpf,eye(2)) * Pc  
Pdes.outputn = Pc.outputn
```

Next, design the LQ gain and state estimator as before (there are now two commands and two measurements).

```
k = lqry(Pdes(1:2,1:2),eye(2),1e-4*eye(2))    % LQ gain  
est = kalman(Pdes(3:4,:),eye(4),1e3*eye(2))  % Kalman estimator  
  
RegMIMO = lqgreg(est,k)    % form MIMO LQG regulator
```

The resulting LQG regulator RegMIMO has two inputs and two outputs.

```
RegMIMO.inputname  
  
ans =  
    'x-force'  
    'y-force'  
  
RegMIMO.outputname
```

```
ans =
    'u-x'
    'u-y'
```

Plot its singular value response (principal gains).

```
sigma(RegMIMO)
```

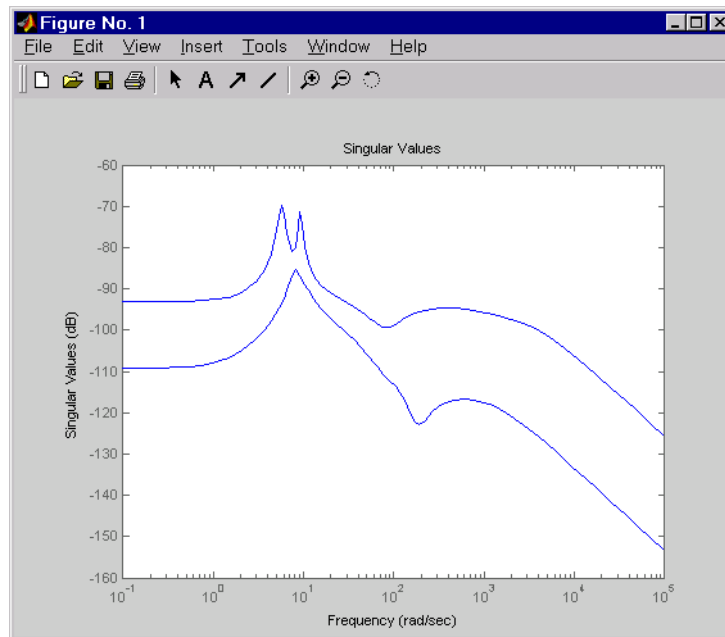

Next, plot the open- and closed-loop time responses to the white noise inputs (using the MIMO LQG regulator for feedback).

```
% Form the closed-loop model
cl = feedback(Pc,RegMIMO,1:2,3:4,+1);

% Simulate with lsim using same noise inputs
lsim(Pc(1:2,3:6),':',cl(1:2,3:6),'-',wxy,t)
```

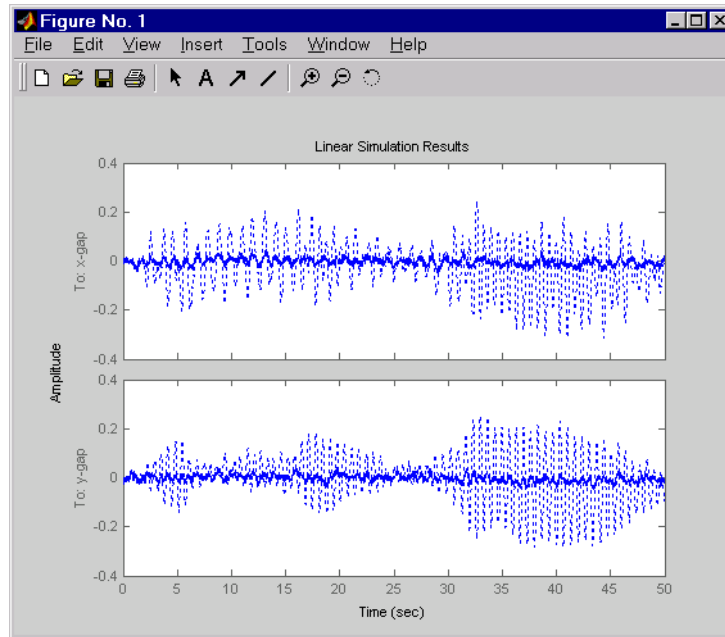

The MIMO design is a clear improvement over the separate SISO designs for each axis. In particular, the level of x/y thickness variation is now comparable to that obtained in the decoupled case. This example illustrates the benefits of direct MIMO design for multivariable systems.

Kalman Filtering

In this section...

“Overview of this Case Study” on page 9-49

“Discrete Kalman Filter” on page 9-50

“Steady-State Design” on page 9-51

“Time-Varying Kalman Filter” on page 9-57

“Time-Varying Design” on page 9-58

“References” on page 9-61

Overview of this Case Study

This final case study illustrates Kalman filter design and simulation. Both steady-state and time-varying Kalman filters are considered.

Consider the discrete plant

$$\begin{aligned}x[n+1] &= Ax[n] + B(u[n] + w[n]) \\ y[n] &= Cx[n]\end{aligned}$$

with additive Gaussian noise $w[n]$ on the input $u[n]$ and data

$$A = \begin{bmatrix} 1.1269 & -0.4940 & 0.1129 \\ 1.0000 & 0 & 0 \\ 0 & 1.0000 & 0 \end{bmatrix};$$

$$B = \begin{bmatrix} -0.3832 \\ 0.5919 \\ 0.5191 \end{bmatrix};$$

$$C = [1 \ 0 \ 0];$$

Our goal is to design a Kalman filter that estimates the output $y[n]$ given the inputs $u[n]$ and the noisy output measurements

$$y_v[n] = Cx[n] + v[n]$$

where $v[n]$ is some Gaussian white noise.

Discrete Kalman Filter

The equations of the steady-state Kalman filter for this problem are given as follows.

Measurement update

$$\hat{x}[n|n] = \hat{x}[n|n-1] + M(y_v[n] - C\hat{x}[n|n-1])$$

Time update

$$\hat{x}[n+1|n] = A\hat{x}[n|n] + Bu[n]$$

In these equations:

- $\hat{x}[n|n-1]$ is the estimate of $x[n]$ given past measurements up to $y_v[n-1]$
- $\hat{x}[n|n]$ is the updated estimate based on the last measurement $y_v[n]$

Given the current estimate $\hat{x}[n|n]$, the time update predicts the state value at the next sample $n+1$ (one-step-ahead predictor). The measurement update then adjusts this prediction based on the new measurement $y_v[n+1]$. The correction term is a function of the *innovation*, that is, the discrepancy.

$$y_v[n+1] - C\hat{x}[n+1|n] = C(x[n+1] - \hat{x}[n+1|n])$$

between the measured and predicted values of $y[n+1]$. The innovation gain M is chosen to minimize the steady-state covariance of the estimation error given the noise covariances

$$E(w[n]w[n]^T) = Q, \quad E(v[n]v[n]^T) = R$$

You can combine the time and measurement update equations into one state-space model (the Kalman filter).

$$\hat{x}[n+1|n] = A(I - MC) \hat{x}[n|n-1] + \begin{bmatrix} B & AM \end{bmatrix} \begin{bmatrix} u[n] \\ y_v[n] \end{bmatrix}$$

$$\hat{y}[n|n] = C(I - MC) \hat{x}[n|n-1] + CM y_v[n]$$

This filter generates an optimal estimate $\hat{y}[n|n]$ of $y[n]$. Note that the filter state is $\hat{x}[n|n-1]$.

Steady-State Design

You can design the steady-state Kalman filter described above with the function `kalman`. First specify the plant model with the process noise.

$$\begin{aligned} x[n+1] &= Ax[n] + Bu[n] + Bw[n] && \text{(state equation)} \\ y[n] &= Cx[n] && \text{(measurement equation)} \end{aligned}$$

This is done by

```
% Note: set sample time to -1 to mark model as discrete
Plant = ss(A,[B B],C,0,-1,'inputname',{'u' 'w'},...
           'outputname','y');
```

Assuming that $Q = R = 1$, you can now design the discrete Kalman filter by

```
Q = 1; R = 1;
[kalmf,L,P,M] = kalman(Plant,Q,R);
```

This returns a state-space model `kalmf` of the filter as well as the innovation gain

```
M
M =
    3.7980e-01
    8.1732e-02
   -2.5704e-01
```

The inputs of `kalmf` are u and y_v , and its outputs are the plant output and state estimates $y_e = \hat{y}[n|n]$ and $\hat{x}[n|n]$.

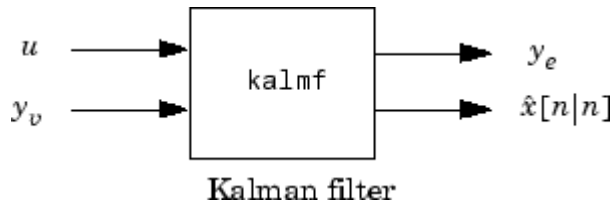

Because you are interested in the output estimate y_e , keep only the first output of kalmf. Type

```
kalmf = kalmf(1,:);
```

```
kalmf
```

```
a =
```

	x1_e	x2_e	x3_e
x1_e	0.7683	-0.494	0.1129
x2_e	0.6202	0	0
x3_e	-0.081732	1	0

```
b =
```

	u	y
x1_e	-0.3832	0.3586
x2_e	0.5919	0.3798
x3_e	0.5191	0.081732

```
c =
```

	x1_e	x2_e	x3_e
y_e	0.6202	0	0

```
d =
```

	u	y
y_e	0	0.3798

```
I/O groups:
```

Group name	I/O	Channel(s)
KnownInput	I	1
Measurement	I	2
OutputEstimate	O	1

Sampling time: unspecified
Discrete-time model.

To see how the filter works, generate some input data and random noise and compare the filtered response y_e with the true response y . You can either generate each response separately, or generate both together. To simulate each response separately, use `lsim` with the plant alone first, and then with the plant and filter hooked up together. The joint simulation alternative is detailed next.

The block diagram below shows how to generate both true and filtered outputs.

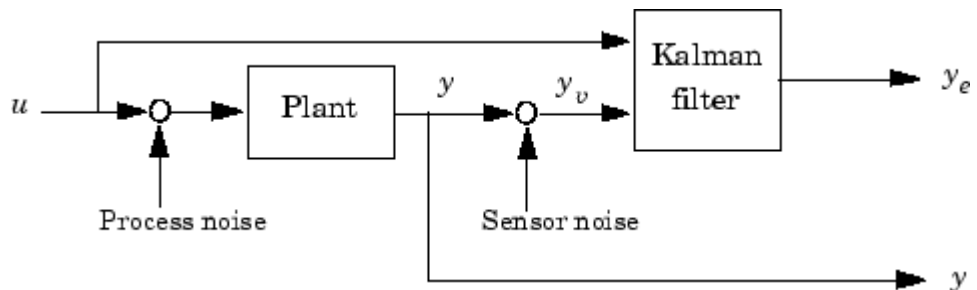

You can construct a state-space model of this block diagram with the functions `parallel` and `feedback`. First build a complete plant model with u, w, v as inputs y and y_v (measurements) as outputs.

```
a = A;
b = [B B 0*B];
c = [C;C];
d = [0 0 0;0 0 1];
P = ss(a,b,c,d,-1,'inputname',{'u' 'w' 'v'},...
      'outputname',{'y' 'yv'});
```

Then use `parallel` to form the following parallel connection.

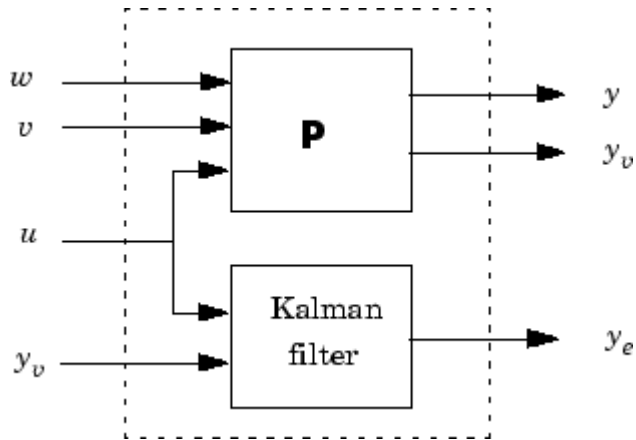

```
sys = parallel(P,kalmf,1,1,[],[])
```

Finally, close the sensor loop by connecting the plant output y_v to the filter input y_v with positive feedback.

```
% Close loop around input #4 and output #2
SimModel = feedback(sys,1,4,2,1)
% Delete yv from I/O list
SimModel = SimModel([1 3],[1 2 3])
```

The resulting simulation model has w , v , u as inputs and y , y_e as outputs.

```
SimModel.inputname
```

```
ans =
    'w'
    'v'
    'u'
```

```
SimModel.outputname
```

```
ans =
    'y'
    'y_e'
```

You are now ready to simulate the filter behavior. Generate a sinusoidal input u and process and measurement noise vectors w and v .

```
t = [0:100]';
u = sin(t/5);

n = length(t)
randn('seed',0)
w = sqrt(Q)*randn(n,1);
v = sqrt(R)*randn(n,1);
```

Now simulate with `lsim`.

```
[out,x] = lsim(SimModel,[w,v,u]);

y = out(:,1); % true response
ye = out(:,2); % filtered response
yv = y + v; % measured response
```

and compare the true and filtered responses graphically.

```
subplot(211), plot(t,y,'--',t,ye,'-'),
xlabel('No. of samples'), ylabel('Output')
title('Kalman filter response')
subplot(212), plot(t,y-yv,'-.',t,y-ye,'-'),
xlabel('No. of samples'), ylabel('Error')
```

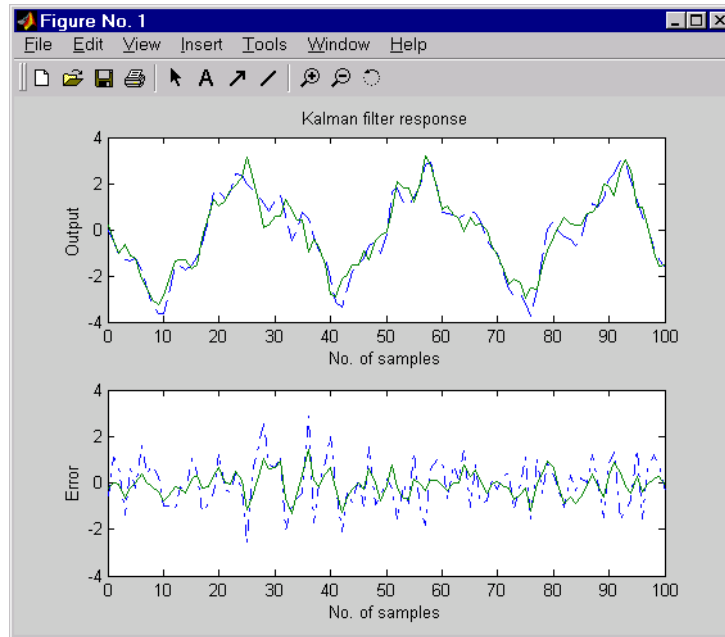

The first plot shows the true response y (dashed line) and the filtered output y_e (solid line). The second plot compares the measurement error (dash-dot) with the estimation error (solid). This plot shows that the noise level has been significantly reduced. This is confirmed by the following error covariance computations.

```

MeasErr = y-yv;
MeasErrCov = sum(MeasErr.*MeasErr)/length(MeasErr);
EstErr = y-ye;
EstErrCov = sum(EstErr.*EstErr)/length(EstErr);
    
```

The error covariance before filtering (measurement error) is

```
MeasErrCov
```

```

MeasErrCov =
    1.1138
    
```

while the error covariance after filtering (estimation error) is only

EstErrCov

EstErrCov =
0.2722

Time-Varying Kalman Filter

The time-varying Kalman filter is a generalization of the steady-state filter for time-varying systems or LTI systems with nonstationary noise covariance. Given the plant state and measurement equations

$$\begin{aligned}x[n+1] &= Ax[n] + Bu[n] + Gw[n] \\y_v[n] &= Cx[n] + v[n]\end{aligned}$$

the time-varying Kalman filter is given by the recursions

Measurement update

$$\begin{aligned}\hat{x}[n|n] &= \hat{x}[n|n-1] + M[n](y_v[n] - C\hat{x}[n|n-1]) \\M[n] &= P[n|n-1]C^T(R[n] + CP[n|n-1]C^T)^{-1} \\P[n|n] &= (I - M[n]C)P[n|n-1]\end{aligned}$$

Time update

$$\begin{aligned}\hat{x}[n+1|n] &= A\hat{x}[n|n] + Bu[n] \\P[n+1|n] &= AP[n|n]A^T + GQ[n]G^T\end{aligned}$$

with $\hat{x}[n|n-1]$ and $\hat{x}[n|n]$ as defined in “Discrete Kalman Filter” on page 9-50, and in the following.

$$\begin{aligned}Q[n] &= E(w[n]w[n]^T) \\R[n] &= E(v[n]v[n]^T) \\P[n|n] &= E(\{x[n] - x[n|n]\}\{x[n] - x[n|n]\}^T) \\P[n|n-1] &= E(\{x[n] - x[n|n-1]\}\{x[n] - x[n|n-1]\}^T)\end{aligned}$$

For simplicity, we have dropped the subscripts indicating the time dependence of the state-space matrices.

Given initial conditions $x[1|0]$ and $P[1|0]$, you can iterate these equations to perform the filtering. Note that you must update both the state estimates $x[n|.]$ and error covariance matrices $P[n|.]$ at each time sample.

Time-Varying Design

Although the Control System Toolbox software does not offer specific commands to perform time-varying Kalman filtering, it is easy to implement the filter recursions in the MATLAB environment. This section shows how to do this for the stationary plant considered above.

First generate noisy output measurements

```
% Use process noise w and measurement noise v generated above
sys = ss(A,B,C,0,-1);
y = lsim(sys,u+w);      % w = process noise
yv = y + v;           % v = measurement noise
```

Given the initial conditions

$$x[1|0] = 0, \quad P[1|0] = BQB^T$$

you can implement the time-varying filter with the following for loop.

```
P = B*Q*B';          % Initial error covariance
x = zeros(3,1);     % Initial condition on the state
ye = zeros(length(t),1);
ycov = zeros(length(t),1);

for i=1:length(t)
    % Measurement update
    Mn = P*C'/(C*P*C'+R);
    x = x + Mn*(yv(i)-C*x); % x[n|n]
    P = (eye(3)-Mn*C)*P;   % P[n|n]

    ye(i) = C*x;
    errcov(i) = C*P*C';
```



```

% Time update
x = A*x + B*u(i);      % x[n+1|n]
P = A*P*A' + B*Q*B';  % P[n+1|n]
end

```

You can now compare the true and estimated output graphically.

```

subplot(211), plot(t,y,'--',t,ye,'-')
title('Time-varying Kalman filter response')
xlabel('No. of samples'), ylabel('Output')
subplot(212), plot(t,y-yv,'-.',t,y-ye,'-')
xlabel('No. of samples'), ylabel('Output')

```

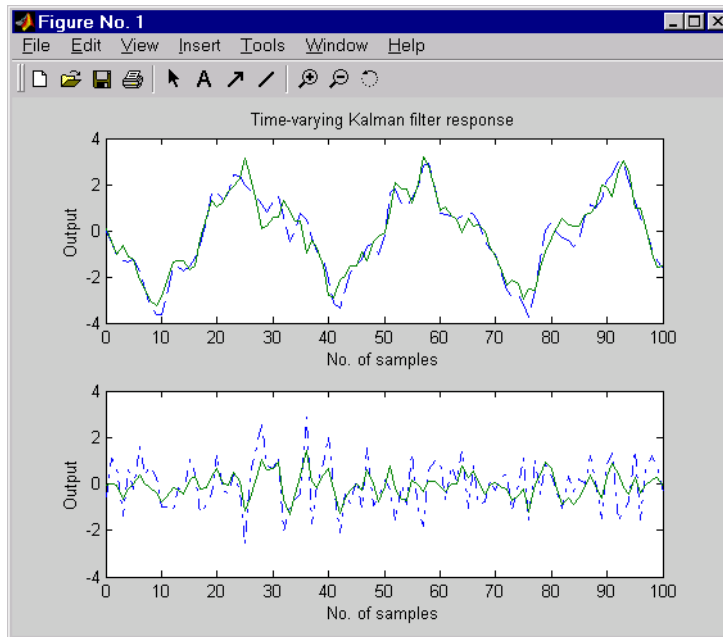

The first plot shows the true response y (dashed line) and the filtered response y_e (solid line). The second plot compares the measurement error (dash-dot) with the estimation error (solid).

The time-varying filter also estimates the covariance `errcov` of the estimation error $y - y_e$ at each sample. Plot it to see if your filter reached steady state (as you expect with stationary input noise).

```
subplot(211)
plot(t,errcov), ylabel('Error covar')
```

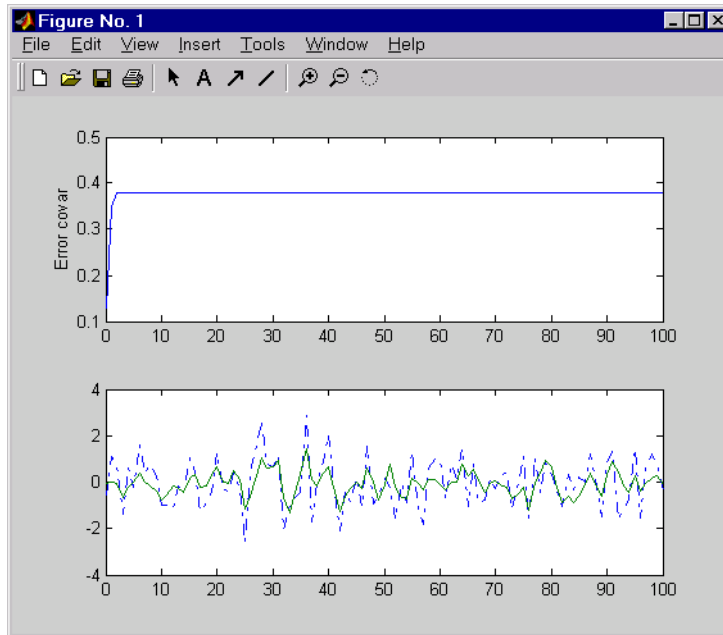

From this covariance plot, you can see that the output covariance did indeed reach a steady state in about five samples. From then on, your time-varying filter has the same performance as the steady-state version.

Compare with the estimation error covariance derived from the experimental data. Type

```
EstErr = y-ye;
EstErrCov = sum(EstErr.*EstErr)/length(EstErr)
EstErrCov =
    0.2718
```

This value is smaller than the theoretical value errcov and close to the value obtained for the steady-state design.

Finally, note that the final value $\mathbf{M}[n]$ and the steady-state value \mathbf{M} of the innovation gain matrix coincide.

\mathbf{M}_n, \mathbf{M}

$\mathbf{M}_n =$
0.3798
0.0817
-0.2570

$\mathbf{M} =$
0.3798
0.0817
-0.2570

References

[1] [Grimble, M.J., *Robust Industrial Control: Optimal Design Approach for Polynomial Systems*, Prentice Hall, 1994, p. 261 and pp. 443-456.

Reliable Computations

- “Scaling State-Space Models” on page 10-2
- “How To Get Accurate Results” on page 10-8

Scaling State-Space Models

In this section...
“Why Scaling Is Important” on page 10-2
“When to Scale Your Model” on page 10-2
“Manually Scaling Your Model” on page 10-3

Why Scaling Is Important

When working with state-space models, proper scaling is important for accurate computations. A state-space model is well scaled when the following conditions exist:

- The entries of the A , B , and C matrices are homogenous in magnitude.
- The model characteristics are insensitive to small perturbations in A , B , and C (in comparison to their norms).

Working with poorly scaled models can cause your model a severe loss of accuracy and puzzling results. An example of a poorly scaled model is a dynamic system with two states in the state vector that have units of light years and millimeters. Such disparate units may introduce both very large and very small entries into the A matrix. Over the course of computations, this mix of small and large entries in the matrix could destroy important characteristics of the model and lead to incorrect results.

For more information on the harmful affects of a poorly scaled model, see the [Scaling Models to Maximize Accuracy](#) demo.

When to Scale Your Model

You can avoid scaling issues altogether by carefully selecting units to reduce the spread between small and large coefficients.

In general, you do not have to perform your own scaling when using the Control System Toolbox software. The algorithms automatically scale your model to prevent loss of accuracy. The automated scaling chooses a frequency range to maximize accuracy based on the dominant dynamics of the model.

In most cases, automated scaling provides high accuracy without your intervention. For some models with dynamics spanning a wide frequency range, however, it is impossible to achieve good accuracy at *all* frequencies and some tradeoff of accuracy in different frequency bands is necessary. In such cases, a warning alerts you of potential inaccuracies. If you receive this warning, evaluate the tradeoffs and consider manually adjusting the frequency interval where you most need high accuracy. For information on how to manually scale your model, see “Manually Scaling Your Model” on page 10-3.

Note For models with satisfactory scaling, you can bypass automated scaling in the Control System Toolbox software. To do so, set the `Scaled` property of your state-space model to 1 (true). For information on how to set this property, see the `set` reference page.

Manually Scaling Your Model

If automatic scaling produces a warning, you can use the `prescale` command to manually scale your model and adjust the frequency interval where you most need high accuracy.

The `prescale` command includes a Scaling Tool GUI, which you can use to visualize accuracy tradeoffs and to adjust the frequency interval where this accuracy is maximized.

To scale your model using the Scaling Tool GUI, you perform the following steps:

- “Opening the Scaling Tool GUI” on page 10-4
- “Specifying the Frequency Axis Limits in the Scaling Tool GUI” on page 10-5
- “Specifying the Frequency Band for Maximum Accuracy in the Scaling Tool GUI” on page 10-6
- “Saving the Scaling in the Scaling Tool GUI” on page 10-6

For an example of using the Scaling Tool GUI on a real model, see the Scaling Models to Maximize Accuracy demo.

For more information about scaling models from the command line, see the `prescale` reference page.

Opening the Scaling Tool GUI

To open the Scaling Tool GUI for a state-space model named `sys`, type

```
prescale(sys)
```

The Scaling Tool GUI resembles one shown in the following figure.

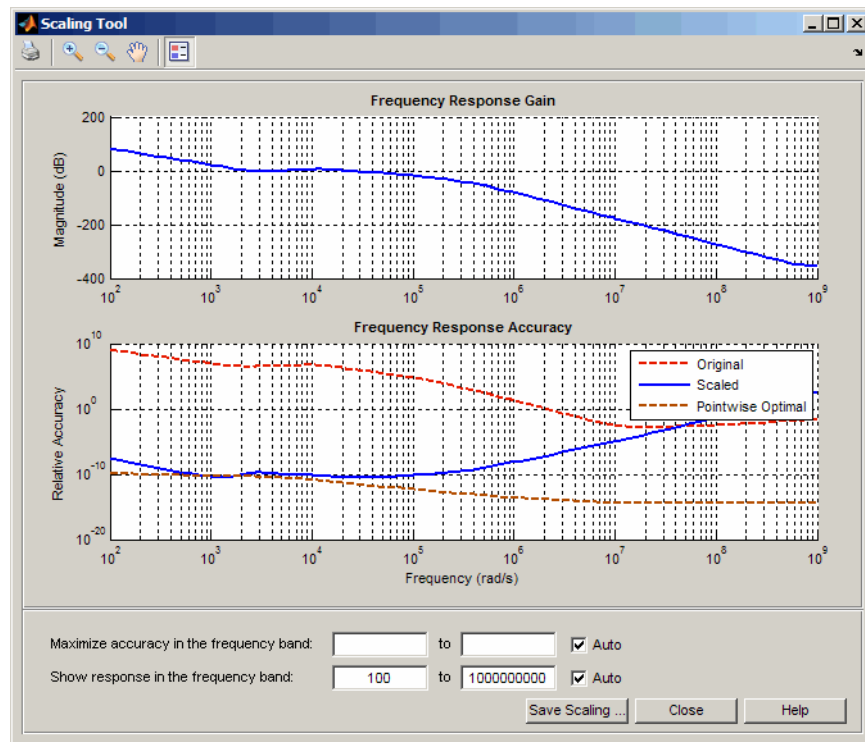

The Scaling Tool GUI contains the following plots:

- The **Frequency Response Gain** plot helps you determine the frequency band over which you want to maximize scaling.

For SISO systems, this plot shows the gain of your model. For MIMO systems, the plot shows the principle gain (largest singular value) of your model.

- The **Frequency Response Accuracy** plot allows you to view the accuracy tradeoffs for your model when maximizing accuracy in a particular frequency bands.

This plot shows the following information:

- Relative accuracy of the response of the original unscaled model in red
- Relative accuracy of the response of the scaled model in blue
- Best achievable accuracy when using independent scaling at each frequency in brown

When you compute some model characteristics, such as the frequency response or the system zeros, the software produces the exact answer for some perturbation of the model you specified. The *relative accuracy* is a measure of the worst-case relative gap between the frequency response of the original and perturbed models. The perturbation accounts for rounding errors during calculation. Any relative accuracy value greater than 1 implies poor accuracy.

Tip If the blue Scaled curve is close to the brown Pointwise Optimal curve in a particular frequency band, you already have the best possible accuracy in that frequency band.

Specifying the Frequency Axis Limits in the Scaling Tool GUI

You can change the limits of the plot axis to view a particular frequency band of interest in the Scaling Tool GUI. To view a particular frequency band, specify the band in the **Show response in the frequency band** fields.

This action updates the frequency axis of the Scaling tool to show the specified frequency band.

Tip To return to the default display, select the **Auto** check box.

Specifying the Frequency Band for Maximum Accuracy in the Scaling Tool GUI

To adjust the frequency band where you want maximum accuracy, set a new frequency band in the **Maximize accuracy in the frequency band** fields. You can visualize accuracy tradeoffs by trying out different frequency bands and viewing the resulting relative accuracy across the frequency band of interest.

Note You can use the **Frequency Response Gain** plot, which plots the gain of your model, to view the dynamics in your model to help determine the frequency band to maximize accuracy.

Each time you specify a new frequency band, the **Frequency Response Accuracy** plot updates with the result of the new scaling. Compare the Scaled curve (blue) to the Pointwise Optimal curve (brown) to determine where the new scaling is nearly optimal and where you need more accuracy.

Tip To return to the default scaling, select the **Auto** check box.

Saving the Scaling in the Scaling Tool GUI

When you find a good scaling for your model, save the scaled model as follows:

- 1 Click **Save Scaling**.

This action opens the **Save to Workspace** dialog box.

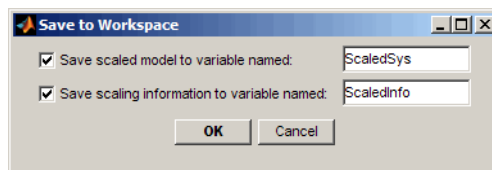

- 2 In the **Save to Workspace** dialog box, verify that any of the following items you want to save are selected, and specify variable names for these items.

- Scaled model
- Scaling information, including:
 - Scaling factors
 - Frequencies used to test accuracy
 - Relative accuracy at each test frequencyFor details about the scaling information, see the `prescale` reference page.

3 Click **OK**.

This action sets the State-Space (@ss) object `Scaled` property of your model to true. When you set this property to `True`, the Control System Toolbox algorithms skip the automated scaling of the model.

How To Get Accurate Results

To ensure that you get accurate results, watch for the issues described in the How to Get Accurate Results category of demos.

SISO Design Tool

- “Overview of the SISO Design Tool” on page 11-2
- “Opening the SISO Design Tool” on page 11-3
- “Using the SISO Design Task Node” on page 11-4
- “Using the SISO Design Task in the Controls & Estimation Tools Manager” on page 11-11
- “SISO Design Task Graphical Tuning Window” on page 11-40
- “Using the Graphical Tuning Window Menu Bar” on page 11-41
- “Using the Graphical Tuning Window Toolbar” on page 11-53
- “Using the Right-Click Menus in the Graphical Tuning Window” on page 11-54
- “LTI Viewer for SISO Design Task Design Requirements” on page 11-74

Overview of the SISO Design Tool

The SISO Design Tool is a graphical-user interface (GUI) that allows you to design compensators.

The SISO Design Tool is made up of the following:

- The SISO Design Task Node in the Control and Estimation Tools Manager, a user interface (UI) that facilitates the design of compensators for single-input, single-output feedback loops through a series of interactive panes.
- The Graphical Tuning Window, a graphical user interface (GUI) for displaying and manipulating the Bode, root locus, and Nichols plots for the controller currently being designed. This window is titled SISO Design for *Design Name*. The Graphical Tuning Window by default displays the root locus and Bode diagrams for your imported systems. The two are dynamically linked; for example, if you change the gain in the root locus, it immediately affects the Bode diagrams as well.
- The SISO Design Task-associated LTI Viewer (For instructions on how to operate the LTI Viewer, see Chapter 12, “LTI Viewer”)
- A tool that automatically generates compensators using PID, internal model control (IMC), or linear-quadratic-Gaussian (LQG) methods.
- A response optimization tool that automatically tunes the system to satisfy design requirements (available if you have Simulink Response Optimization software installed).

This tool is used extensively in the *Control System Toolbox Getting Started Guide*. In particular, you should read Chapter 4, “Designing Compensators,” of that book to see how to do typical design tasks with the SISO Design Tool. This document, on the other hand, is a reference that describes all available options for the SISO Design Tool.

Opening the SISO Design Tool

Type

```
sisotool
```

to open the SISO Design Task node in the Control and Estimation Tools Manager and the Graphical Tuning Window.

If you want to match the SISO Design Task pictures shown in this section, type

```
load ltiexamples
```

at the MATLAB prompt. This loads the same set of linear models that this document uses as examples in the SISO Design Tool. The examples all use the Gservo system for the system you want to control. Type

```
sisotool(Gservo)
```

at the MATLAB prompt to load the Gservo system into the SISO Design Tool.

Using the SISO Design Task Node

In this section...

“The SISO Design Task Node” on page 11-4

“SISO Design Task Node Menu Bar” on page 11-5

The SISO Design Task Node

This picture shows the SISO Design Task node in the Control and Estimation Tools Manager.

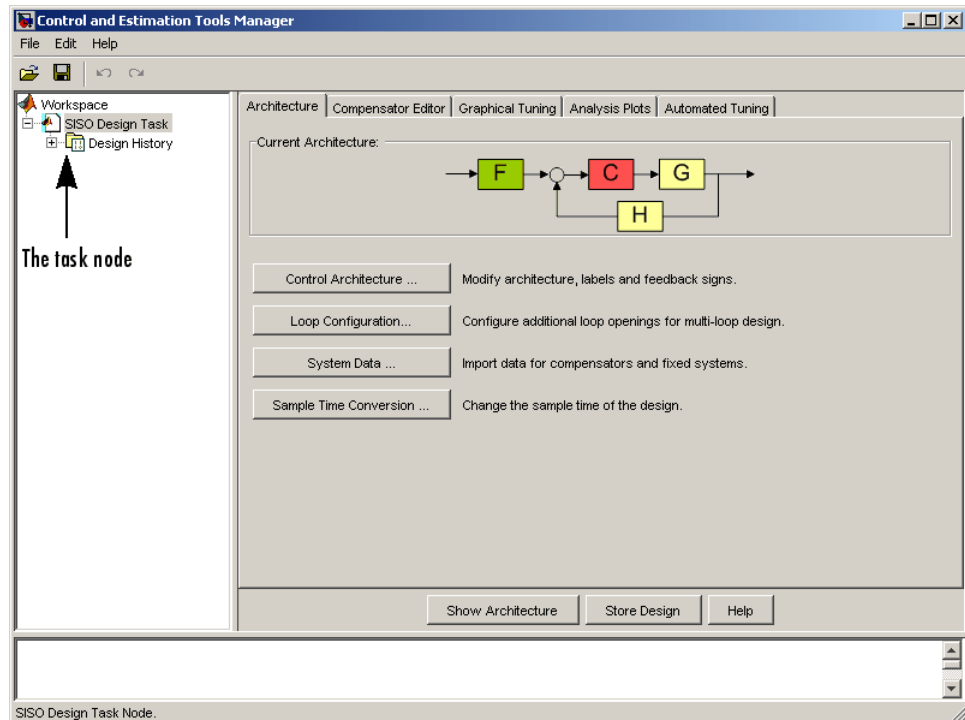

SISO Design Task Node on the Control and Estimation Tools Manager

SISO Design Task Node Menu Bar

The SISO Design Task node menu bar contains the following menus:

File Edit Help

File Menu Options

- Load

To load a saved SISO Design Tool project, select **Load** from the **File** menu. This opens the Load Projects window.

Projects are saved as MAT-files. Select the project you want to load from the list, or click ... to browse for projects you can select from, and click **OK**.

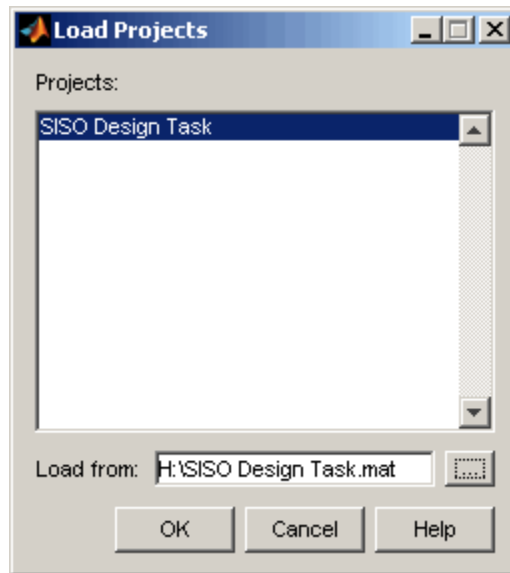

- Save

You can exit the MATLAB technical computing environment and later restore the SISO Design Tool to the state you left it in by saving the project. Select **Save** from the **File** menu. This opens the **Save Projects** window.

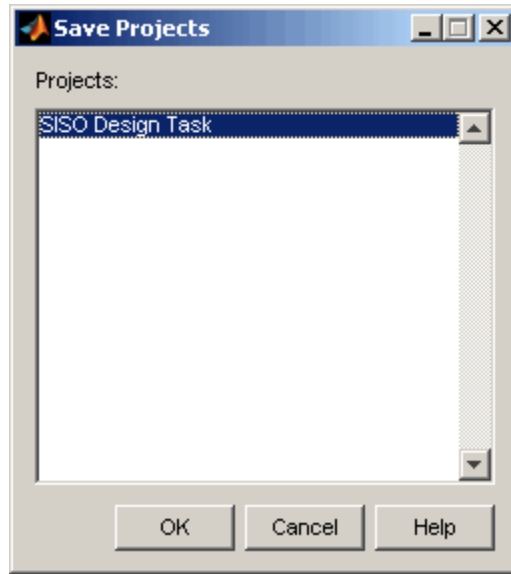

To save a project, specify a file name and click **OK**. The current state and configuration of your SISO Design Tool are saved as a MAT-file. To load a saved project, select **Load** from the **File** menu (see previous bullet).

- **Export**

Selecting **Export** from the **File** menu opens the SISO Tool Export window.

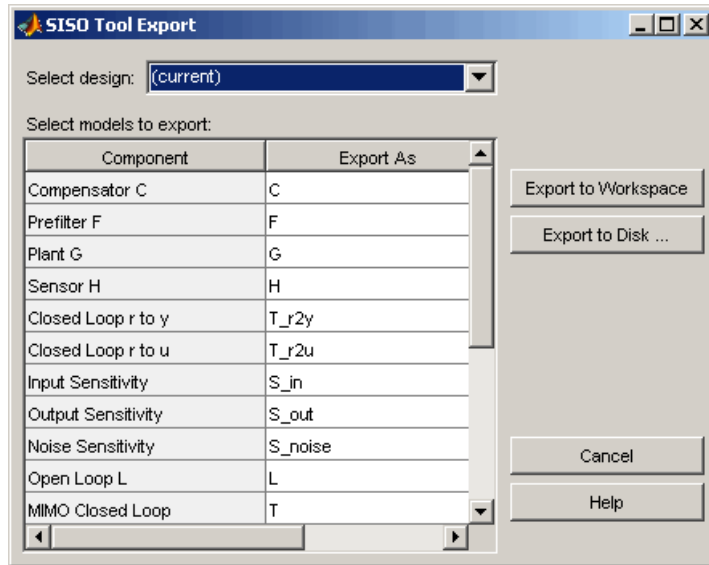

With this window, you can:

- Export models to the MATLAB workspace or to a disk
- Rename models when exporting
- Save variations on models, including open and closed loop models, sensitivity transfer functions, and state-space representations

Exporting to the Workspace. To export models to the MATLAB workspace, follow these steps:

- 1** Select the model you want to export from the Component list by left-clicking the model name. To select more than one model, hold down the **Shift** key if they are adjacent on the list. If you want to save nonadjacent models, hold down the **Ctrl** key while selecting the models.
- 2** For each model you want to save, specify a name in the model's cell in the Export As list. A default name exists if you do not want to assign a new name.
- 3** Click **Export to Workspace**.

Exporting to a MAT-file. If you want to save your models in a MAT-file, follow steps 1 and 2 and click **Export to Disk**, which opens this window.

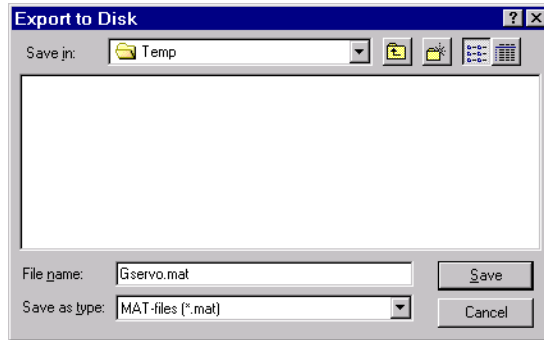

Choose where you want to save the file in the **Save in** field and specify the name you want for your MAT-file in the **File name** field. Click **Save** to save the file.

- **Close**

Use **Close** to close the SISO Design Tool. This closes all components of the SISO Design Tool.

Edit Menu Options

- **Undo**

Use **Undo** to go back in design steps. Note that the **Undo** menu changes when the task you have just performed changes. For example, if you change the compensator gain, the **Undo** menu item now reads **Undo Edit Gain**.

- **Redo**

Use **Redo** to go forward in the design steps. You can only use **Redo** if you have previously used **Undo**. Like the **Undo** menu, the **Redo** menu changes when the task you have just performed changes. For example, if you change the compensator gain, and then select **Undo Edit Gain**, the Redo menu item becomes **Redo Edit Gain**.

- **SISO Tool Preferences**

Select **SISO Tool Preferences** from the **File** menu to open the **SISO Tool Preferences** dialog box.

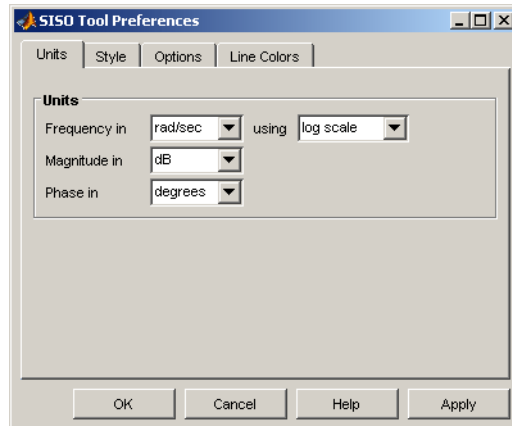

You can use this window to do the following:

- Change units
- Add plot grids, change font styles for titles, labels, etc., and change axes foreground colors
- Change the compensator format
- Show or hide system poles and zeros in Bode diagrams

For a discussion of this window's features, see [Setting Toolbox Preferences](#) online in the Control System Toolbox documentation.

- **Help**

Selecting **About the Control and Estimation Tools Manager** opens a window with the version number and a copyright notice for this product.

Buttons Available from Any Pane

Showing the Control Architecture. Click **Show Architecture** to open a window that displays the block diagram for your model. For example,

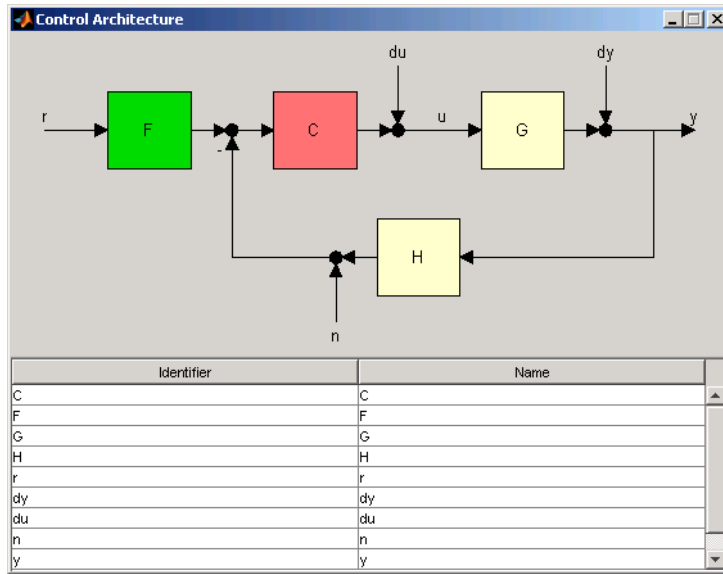

Below the block diagram is a table that shows the default names for each part of the block diagram and the assigned name, if you have one.

Store Design. Click **Store Design** to save your design to your SISO Design Task node. Click on **Design** under the node to see a snapshot summary of your design. Click on the **Design History** node to show a list of all stored designs.

Using the SISO Design Task in the Controls & Estimation Tools Manager

In this section...

“Architecture” on page 11-11

“Compensator Editor” on page 11-17

“Graphical Tuning” on page 11-18

“Analysis Plots” on page 11-21

“Automated Tuning” on page 11-23

Architecture

Use the Architecture pane for

- “Modifying Block Diagram Structure” on page 11-12
- “Configuring Loops” on page 11-14
- “Importing Models” on page 11-15
- “Changing Sample Times” on page 11-16

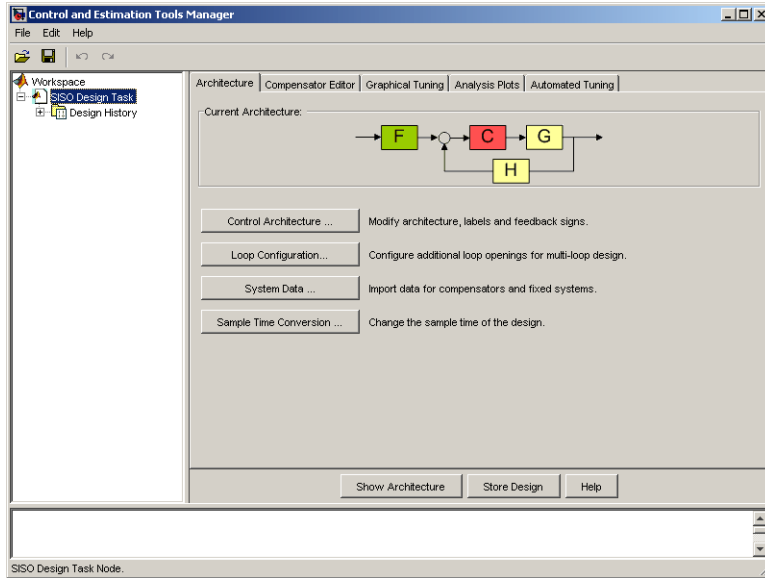

Architecture Pane on the SISO Design Task Node

Modifying Block Diagram Structure

Click **Control Architecture** to change the feedback structure and label signals and blocks. The following pane appears:

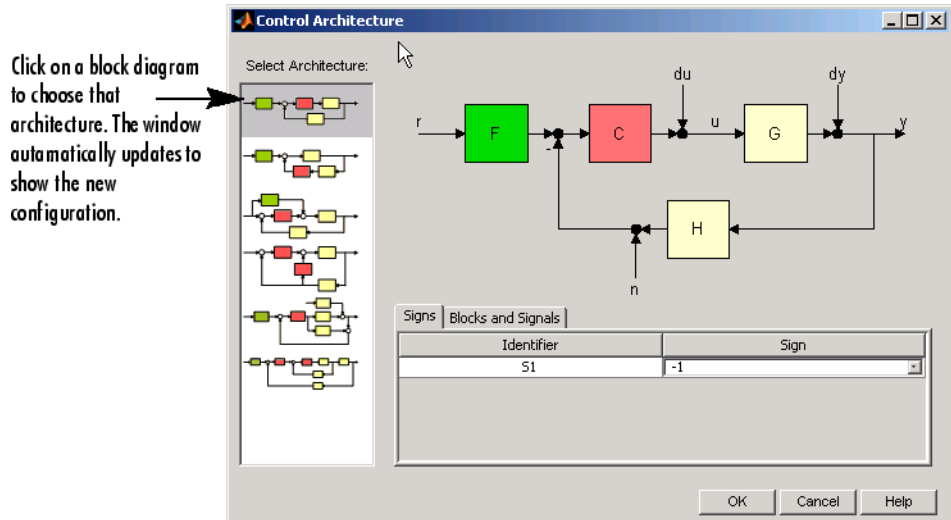

Select an architecture from the list of block configurations. These include compensator in the forward path, compensator in the feedback path, feedforward controller, and various multi-loop configurations.

Each configuration has associated Signs and Blocks and Signals panes. This figure shows the Signs pane.

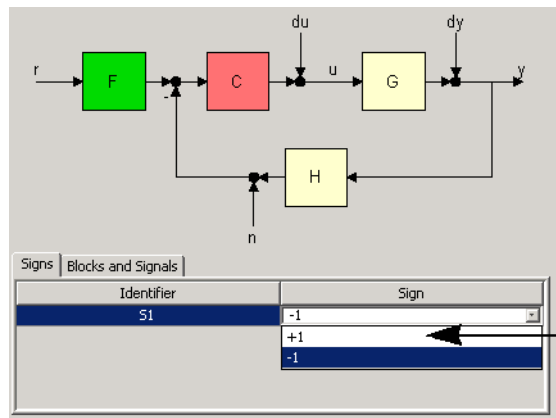

Use the pulldown menu to toggle between + and - for feedback signals at a summing junction.

The Blocks and Signals pane displays the generic identifier, for example F for the prefilter block, and a default name.

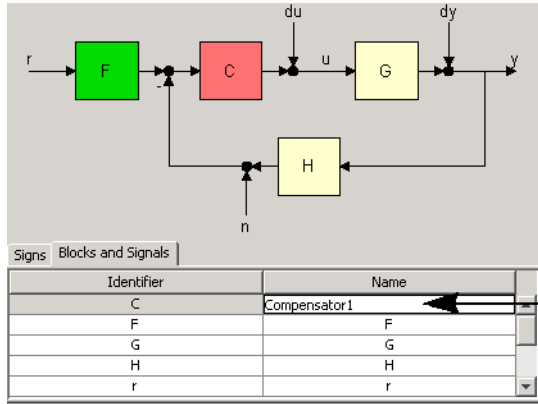

Double-click here to change name to a new one.
On the Signs pane, use it menu to toggle between

Configuring Loops

Click **Loop Configuration** to configure loops for multi-loop design by opening signals to remove the effects of other feedback loops.

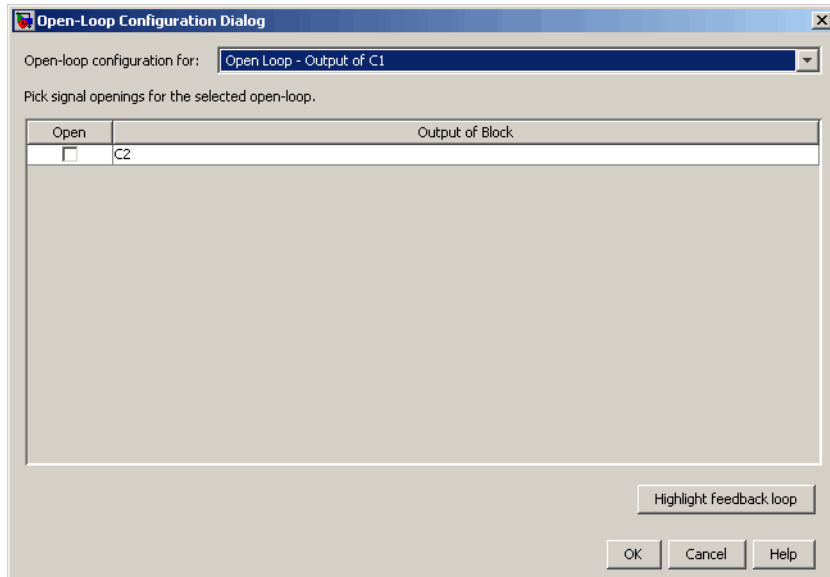

To specify openings for a given open loop, select the loop in the combo box. Click **Highlight Feedback Loop** to see the effects of the selected openings.

For an example of how to use this window in design, see Multi-Loop Compensator Design.

Importing Models

Click **System Data** on the Architecture pane to import models into your system. This opens the System Data dialog box, which is shown below.

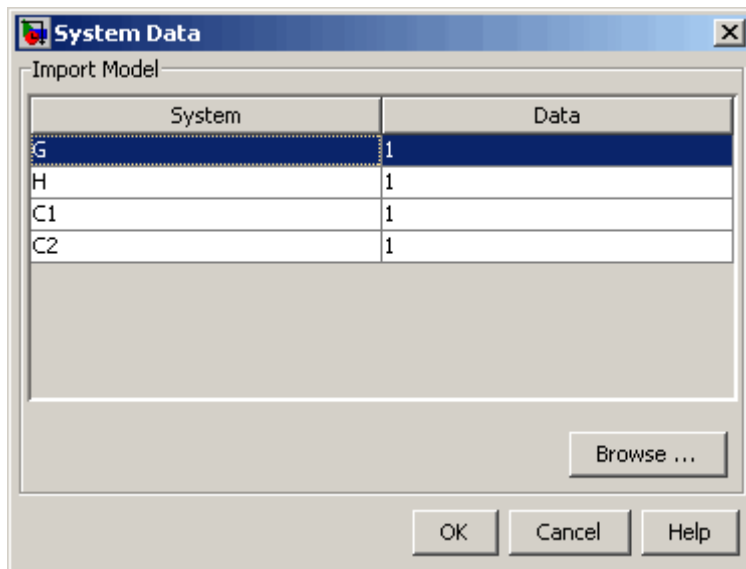

You can import models for the plant (**G**), compensator (**C**), prefilter (**F**), and/or sensor (**H**). To import a model:

- 1 Select a system in the System column and click **Browse**. The Model Import dialog box opens, as shown below.

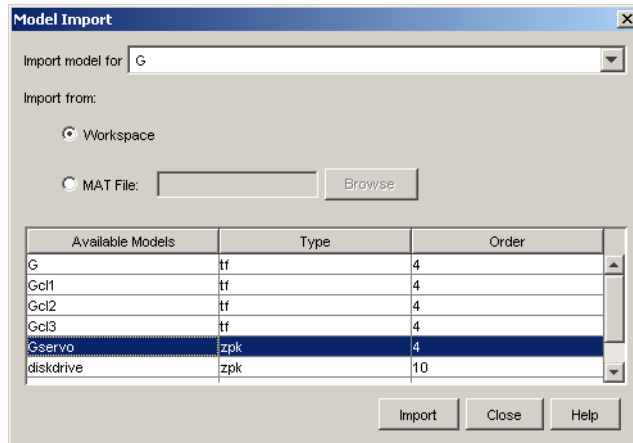

2 Select a model from the **Available Models** list. You can import models from:

- The MATLAB workspace
- A MAT-file

3 Click **Import**, then click **Close**. You can now see the model loaded into the system selected in the **System Data** dialog.

4 Click **OK**. The Graphical Tuning window is updated with the model you loaded.

Alternatively, you can import by entering a valid expression or variable (double or LTI object) in the Data column in the System Data window.

Changing Sample Times

Click **Sample Time Conversion** to convert the sample time of the system or switch between different sample times to design different compensators.

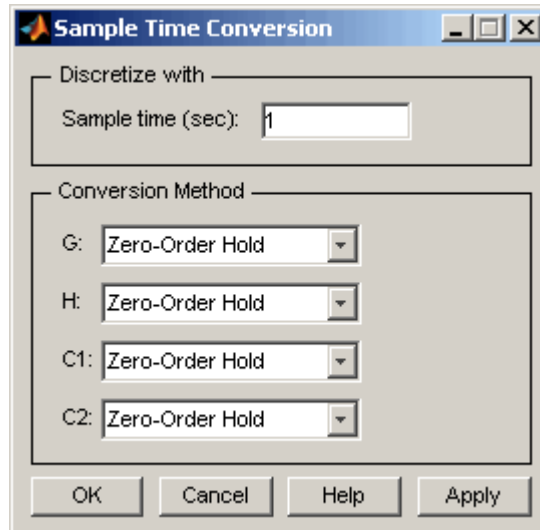

Choose from Zero-Order Hold, First-Order Hold, Impulse Variant, Tustin, Tustin w/Prewarping, and Matched Pole-Zero.

For a full description, see “Continuous/Discrete Conversions Using the Sample Time Conversion Dialog Box” on page 11-47.

Compensator Editor

Use the Compensator Editor for adding or editing gains, poles, and zeros.

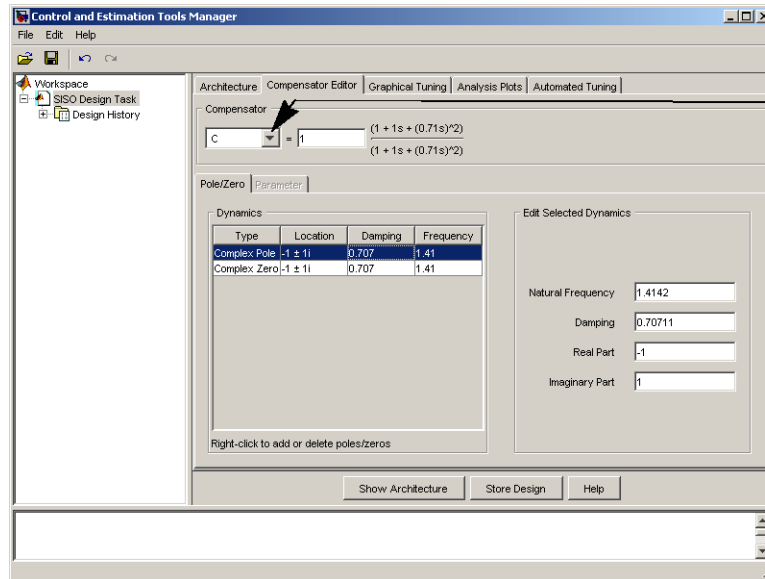

Compensator Editor Pane on the SISO Design Task Node

- 1 Enter the compensator gain in the text box in the top part of the pane.
- 2 Add or remove compensator poles and zeros by right-clicking in the **Dynamics** table.
- 3 Adjust pole and zero settings by entering values directly in the **Edit Selected Dynamics** group box.

Graphical Tuning

Use the Graphical Tuning pane for

- “Configuring Design Plots for the Graphical Tuning Window” on page 11-19
- “Selecting New Loops to Tune” on page 11-21
- “Refocusing on the Graphical Tuning Window” on page 11-21

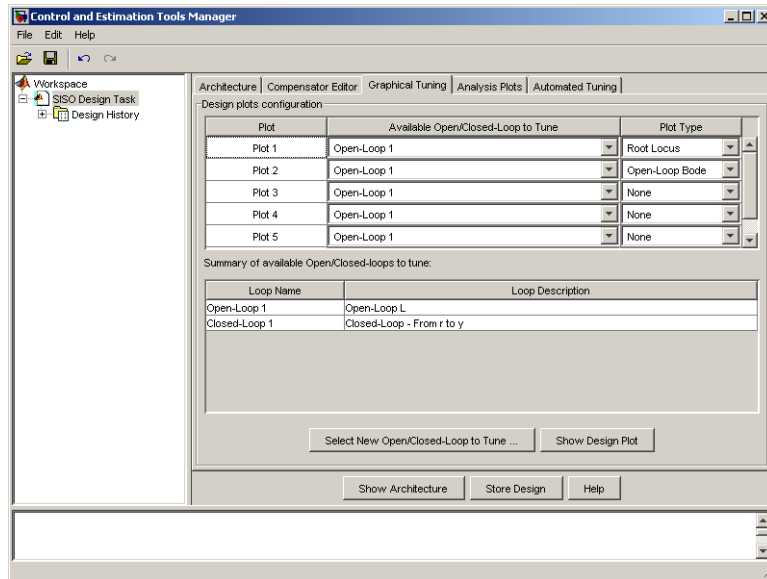

Graphical Tuning Pane on the SISO Design Task Node

Configuring Design Plots for the Graphical Tuning Window

Click the **Graphical Tuning** tab to configure design plots displayed in the Graphical Tuning Window.

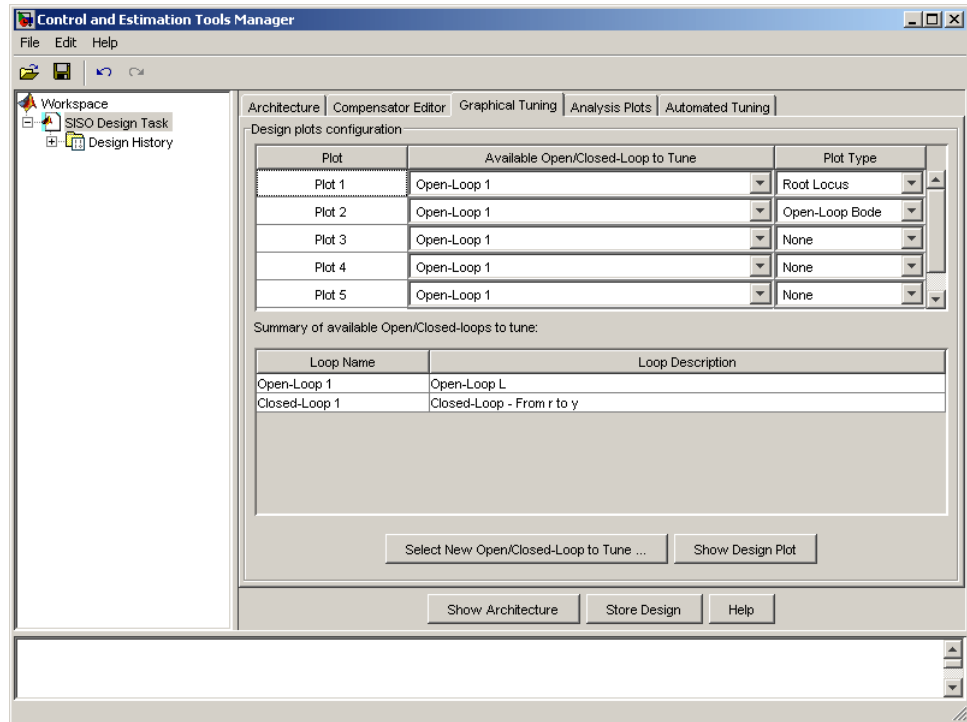

In the Graphical Tuning window, use design plots to graphically manipulate system response. These design plots are dynamically linked to the SISO Design Task. When you change the dynamics of your compensator in either the SISO Design Task or the Graphical Tuning window, the design updates in both places.

For open-loop responses, the available plot types are:

- Root locus
- Nichols
- Bode

For closed-loop responses, the available plot type is Bode.

Selecting New Loops to Tune

Click **New Open/Closed Loops to Tune** to open a window for specifying new loops to tune.

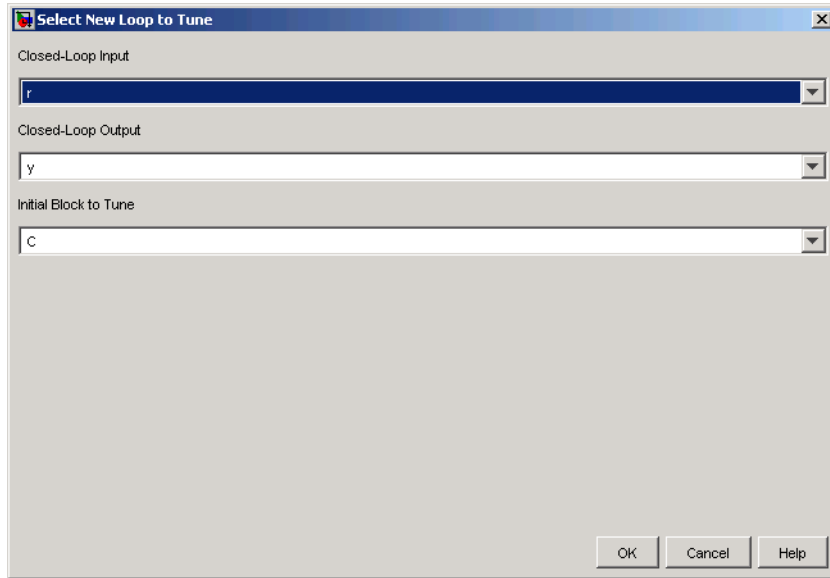

Use the pull down menus to select the desired closed loop to tune by specifying the input, output, and blocks for tuning. Using the dialog box, you can select additional closed loops to tune.

Any loop you specify is displayed in the **Summary of Available Loops to Tune** in the Graphical Tuning pane. The list is also available in the **Design plots configuration** table of the same pane. You can use the latter for configuring design plots.

Refocusing on the Graphical Tuning Window

Click **Show Design Plot** to change the focus to the Graphical Tuning window.

Analysis Plots

Use the Analysis Plots pane for

Adding New Response Plots

Click **Add Responses** to open a window with three drop-down menus for selecting open and closed loop responses for various input and output nodes in the control architecture block diagram. This allows you to select additional responses for viewing. The **Response** table updates automatically to include the selected response.

Opening or Changing the Focus to the LTI Viewer

Click **Show Analysis Plot** to open a new LTI Viewer for SISO Design with the response plots that you selected. All the plots open in one instance of the LTI Viewer.

Automated Tuning

Use the **Automated Tuning** pane to select a method for automatic tuning of your compensator design. Automated tuning methods help you design an initial compensator for a SISO loop that satisfies your design specifications.

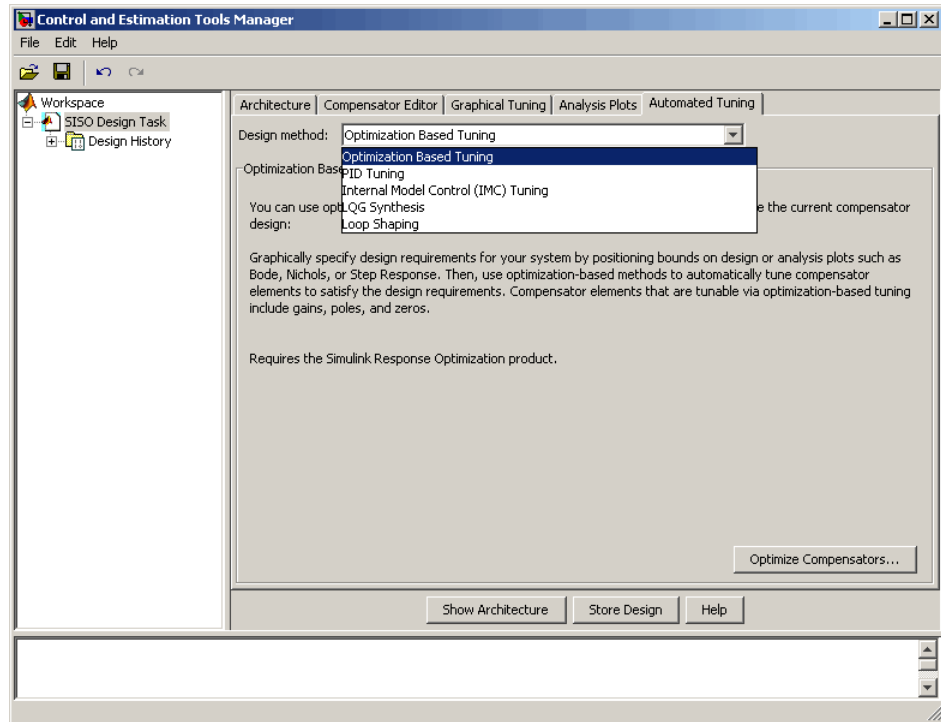

You can choose among the following algorithms:

- “Optimization-Based Tuning” on page 11-26 — Optimizes compensator parameters using design requirements implemented in graphical tuning and analysis plots.
- “PID Tuning” on page 11-27 — Searches for initial PID controller parameters using the Ziegler-Nichols, IMC Based, and Singular Frequency Based methods.
- “Internal Model Control (IMC) Tuning” on page 11-34 — Obtains a full-order stabilizing feedback controller using the IMC design method.
- “LQG Synthesis” on page 11-36 — Designs a full-order stabilizing feedback controller as a Linear-Quadratic-Gaussian (LQG) tracker.
- “Loop Shaping” on page 11-37 — Finds a full-order stabilizing feedback controller with a desired open loop bandwidth or shape.

After you select a tuning algorithm, the pane updates to display the corresponding options.

Note If the particular automated tuning method you are using does not apply or fails, try selecting different tuning specifications or switch to a different tuning algorithm.

Stability of an Effective Plant for Automated Tuning

Knowing the stability of the effective plant in your model may help you understand which automated tuning methods work for your model. Some of the automated tuning methods only apply to compensators whose open loops ($L = C\hat{P}$) have stable effective plants (\hat{P}).

An *effective plant* is the system controlled by the compensator you design and contains all elements of the open loop in your model other than this compensator. The following figure shows two examples of effective plants.

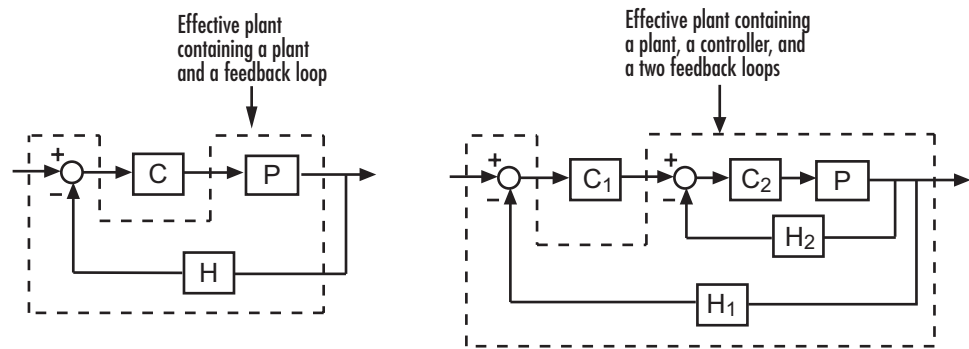

Generic Work Flow

For each method, follow these steps to do your design:

- 1 Select an automated tuning algorithm from the **Design method** drop-down menu.

- 2 If you select **Optimization-Based Tuning**, stop here and see “Optimization-Based Tuning” on page 11-26.
- 3 Select a compensator from the drop-down menu.
- 4 Determine how you want the compensator to perform and set the tuning specifications.
- 5 Click **Update Compensator** and notice the changes in the associated design and analysis plots.

Note If you encounter a disabled **Update Compensator** button, try selecting different tuning specifications (Step 4) or switch to a different tuning algorithm (Step 1). The disabled button means that the current method does not work for your model.

Optimization-Based Tuning

Optimization-based tuning creates a subdesign task to assist in the tuning and optimization of control systems. If you have Simulink Response Optimization software installed, you can use this method to either:

- Directly tune response signals within Simulink models.
- Tune responses of LTI systems using a SISO Design Task.

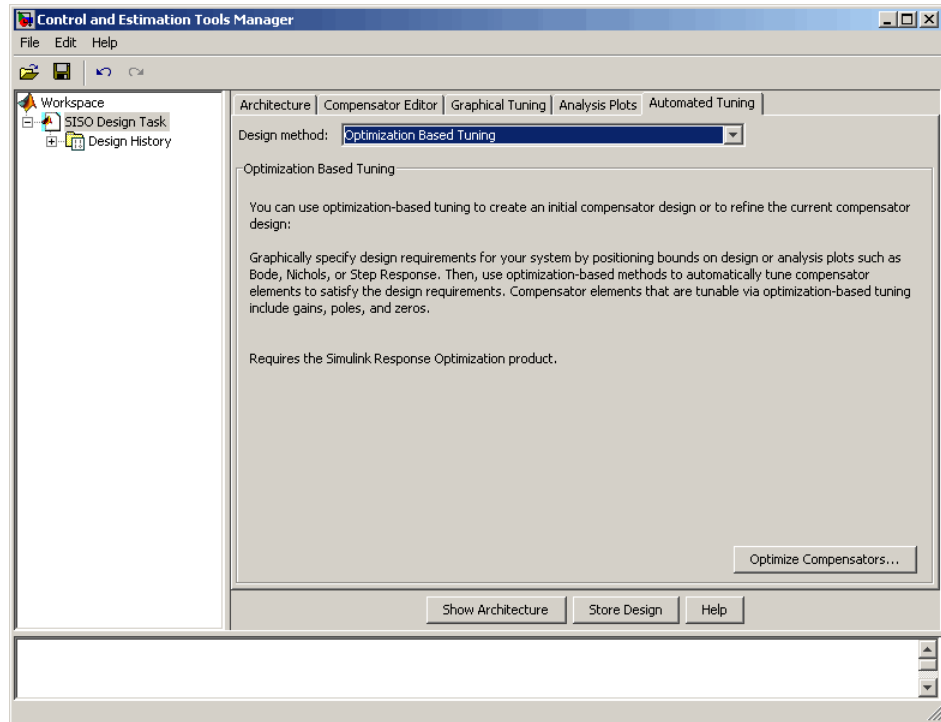

See “Frequency Domain Response Optimization Example” in the Simulink Response Optimization documentation for more details.

PID Tuning

PID (proportional-integral-derivative) control is the most popular control technique used in modern industry. Four PID tuning algorithms are provided in the SISO Design Tool, including one that supports unstable systems (Singular frequency based tuning). In most cases, the PID controllers resulting from PID tuning provide acceptable performance.

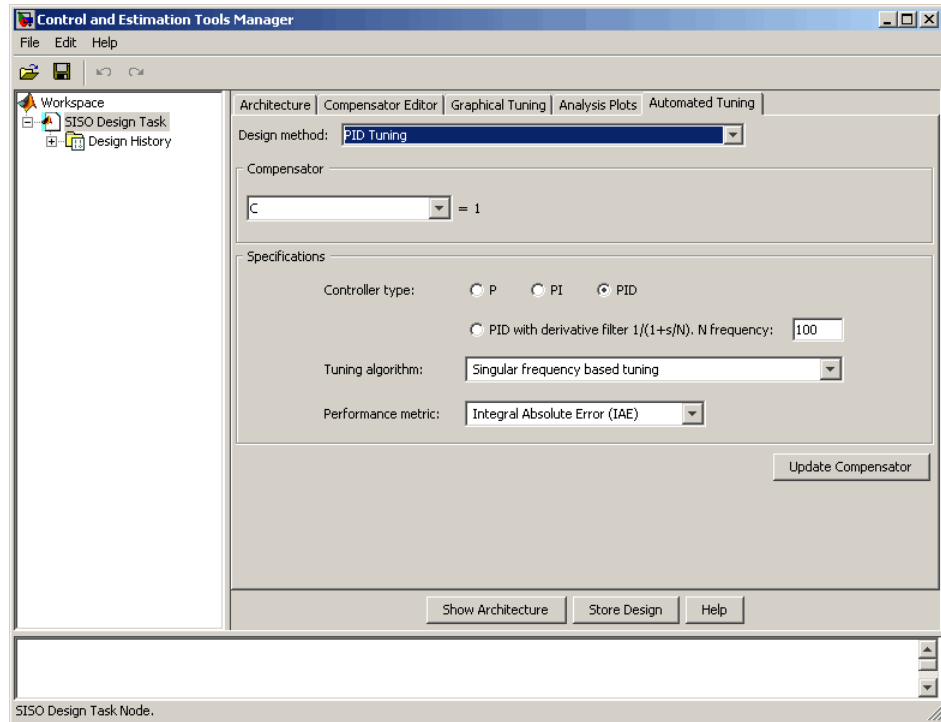

To do a PID design:

1 Select a controller type from the following options:

- P — Proportional-only control ($C = K_p$)
- PI — Proportional-integral control ($C = K_p + \frac{K_I}{s}$)
- PID — Proportional-integral-derivative control ($C = K_p + \frac{K_I}{s} + K_d s$)
- PIDF — PID control with a lowpass filter ($C = K_p + \frac{K_I}{s} + \frac{K_d s}{\frac{s}{N} + 1}$)

If you choose this controller type, specify the **N frequency** (bandwidth) in rad/s.

2 Select an algorithm from the **Tuning algorithm** list:

- **Singular frequency based tuning** — This method implements robust control design techniques to locate stabilizing PID regions in parameter space. This method supports unstable systems.
- **Ziegler-Nichols open loop** — Controller settings are based on a first-order model with a time delay that approximates the plant. This method uses the Chien-Hrones-Resnick (CHR) setting with 20% overshoot.
- **Ziegler-Nichols closed loop** — Controller settings are obtained from a modified Ziegler-Nichols lookup table, based on the ultimate gain and frequency of the system.

Ziegler-Nichols closed loop does not apply to first-order or second-order systems with time delay. If you select Ziegler-Nichols closed loop for these cases, the tuning algorithm will automatically be switched to Ziegler-Nichols open loop.

- **Internal Model Control (IMC) based tuning** — Controller settings are derived from a full-order IMC controller (note that this is different from selecting “Internal Model Control (IMC) Tuning” on page 11-34 as the full-order compensator tuning method).

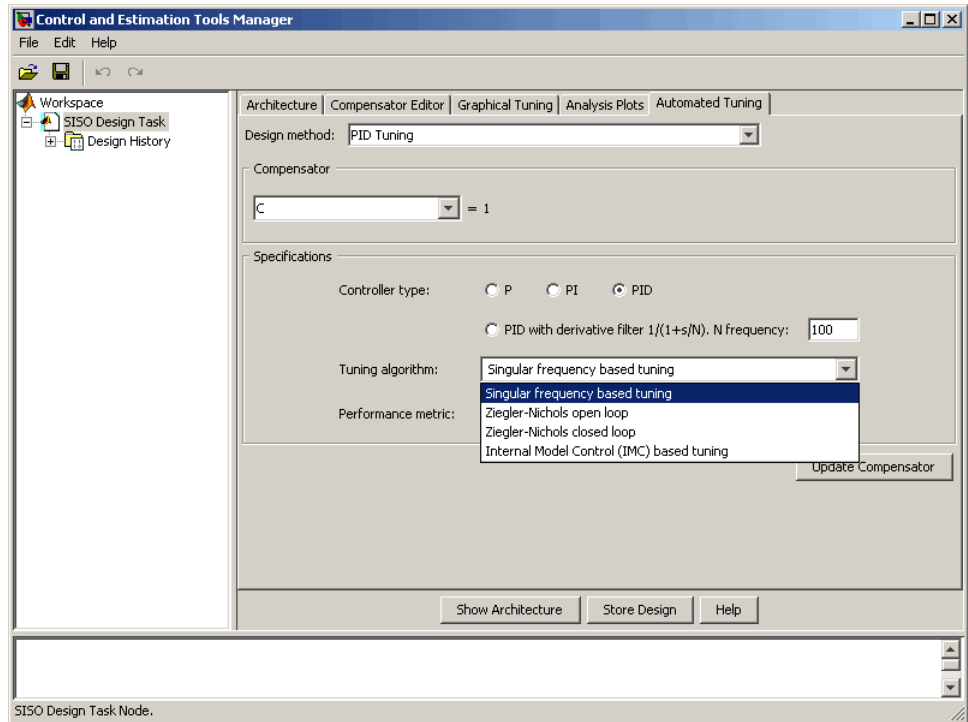

3 Set the tuning options available for your selected tuning algorithm type.

- If you chose singular frequency based tuning, select one of these options from the **Performance metric** list:
 - Integral Absolute Error (IAE)
 - Integral Square Error (ISE)
 - Integral Time Absolute Error (ITAE)
 - Integral Time Square Error (ITSE)

These are typical controller performance criteria based on time response.

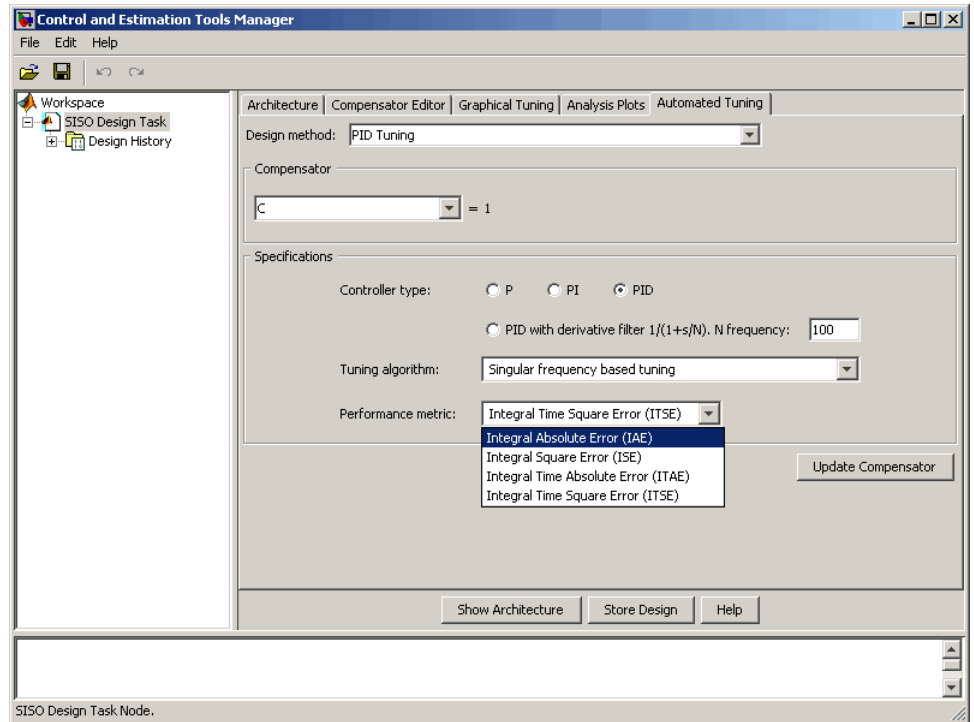

- If you chose Ziegler-Nichols open loop, select a tuning preference by clicking one of these option buttons:
 - **Setpoint tracking**
 - **Load disturbance rejection**

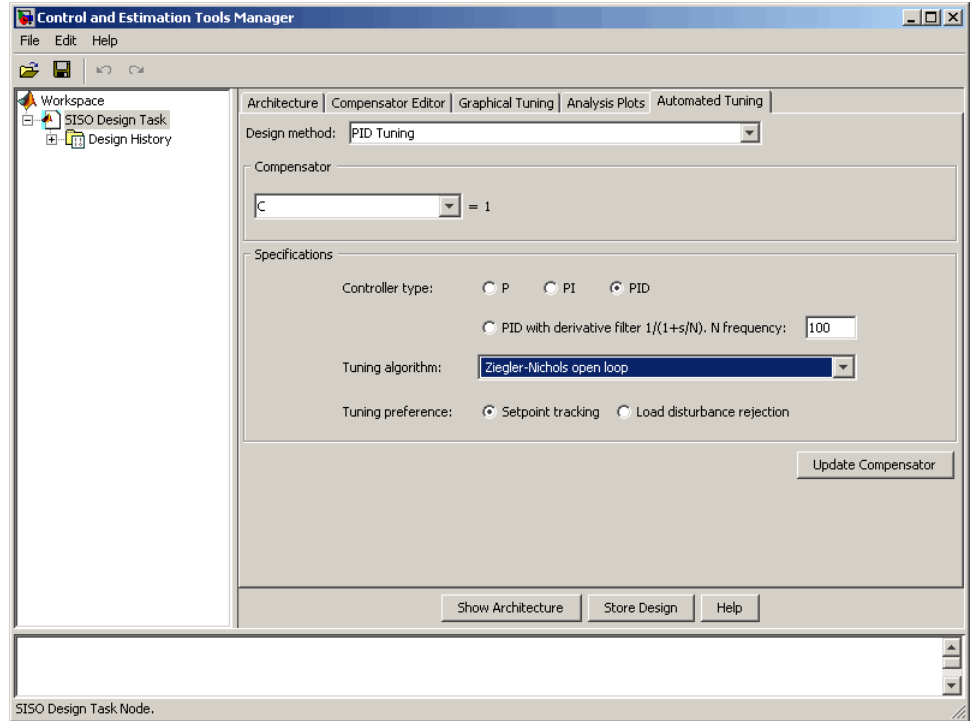

- If you chose Ziegler-Nichols closed loop, select a tuning formula by clicking one of these option buttons:
 - **Ziegler-Nichols**
 - **Tyreus-Luyben**
 - **Astrom-Hagglund**

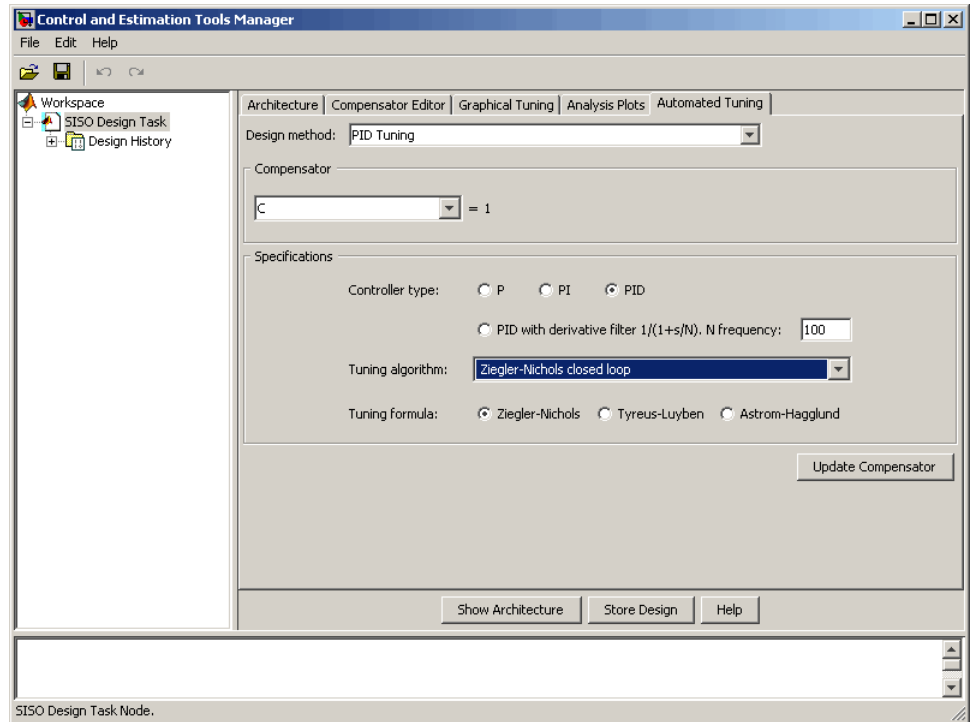

- If you chose Internal Model Control (IMC) based tuning, use the slider bar to set the **Dominant closed-loop time constant**.

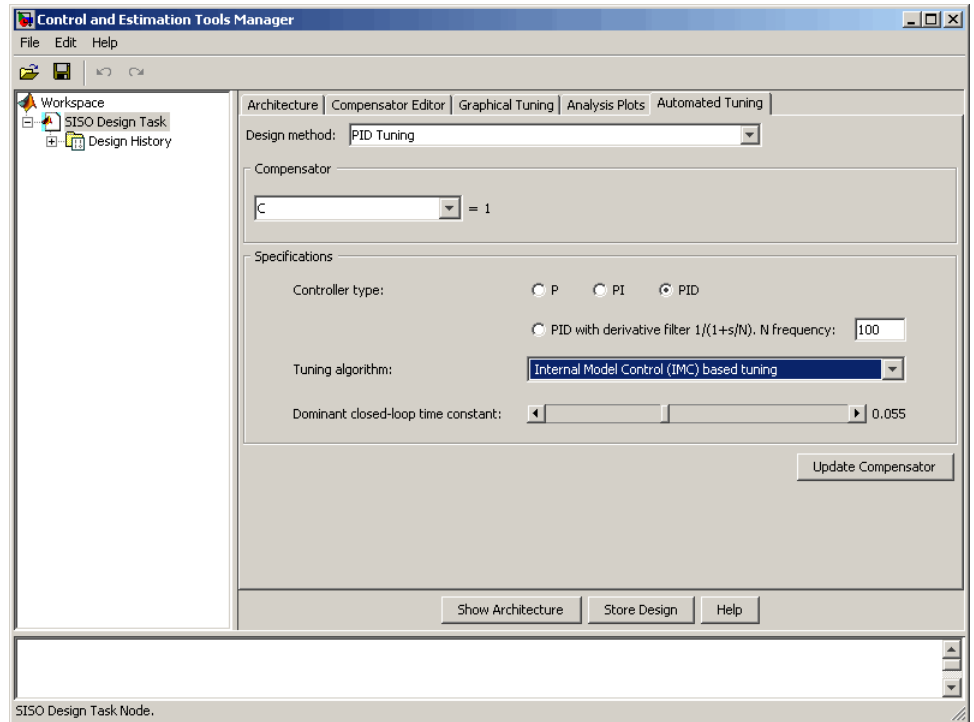

4 Click **Update Compensator**.

Internal Model Control (IMC) Tuning

IMC design generates a full-order feedback controller that guarantees closed-loop stability when there is no model error. It also contains an integrator, which guarantees zero steady-state offset for plants without a free differentiator. You can use this tuning method for both stable and unstable plants.

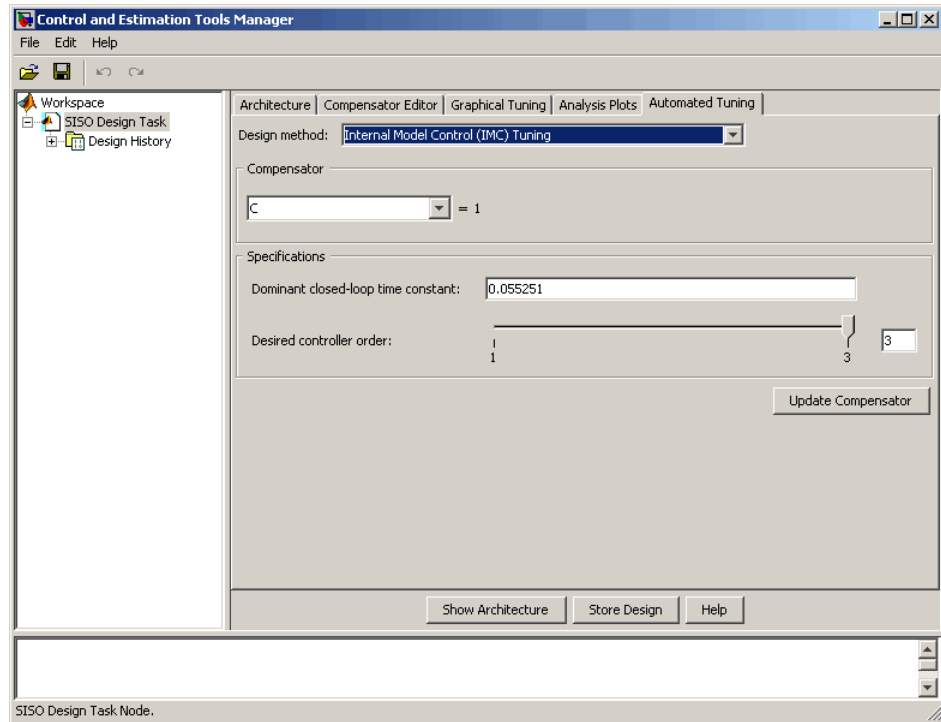

To design an IMC controller:

- 1** Specify a value in the **Dominant closed-loop time constant** field. The initial value is set as 5% of the open-loop settling time. In general, increasing this value slows down the closed system and makes it more robust.
- 2** Specify a value in the **Desired controller order** field using the slider. After you obtain a full-order feedback controller, you can try to reduce its order. You may lose performance and closed-loop stability if you reduce the order.
- 3** Click **Update Compensator**.

LQG Synthesis

LQG tracker design generates a full-order feedback controller that guarantees closed-loop stability. It also contains an integrator, which guarantees zero steady-state error for plants without a free differentiator.

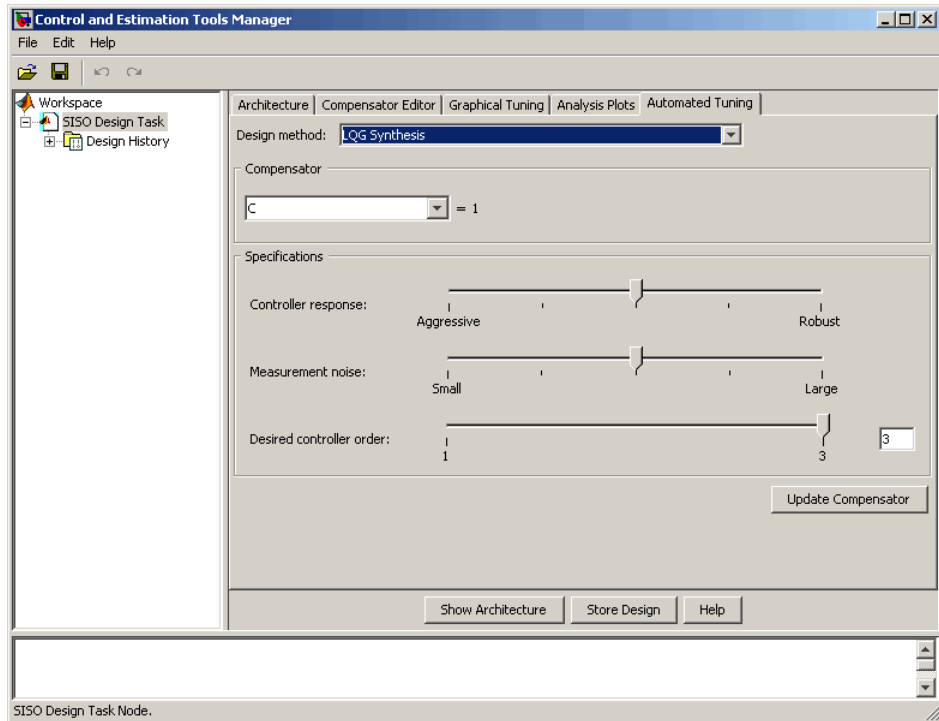

To design an LQG controller:

- 1 Specify your preference for controller response using the **Controller response** slider.

- Move the slider to the left for aggressive control response.

This means that large overshoot is more heavily penalized so that the controller acts more aggressively. If you believe your model is accurate and that the manipulated variable has a large enough range, an aggressive controller is more desirable.

- Move the slider to the right for robust control response.
- 2 Specify your estimation of the level of measurement noise using the **Measurement noise** slider.
 - Move the slider to the left for small measurement noise.

This means that you expect low noise from the process output measurement. Because this measurement is used by the Kalman estimator, process disturbances are picked up more accurately by the estimated states. In this case, the controller is freer from robustness considerations.
 - Move the slider to the right for large measurement noise. This results in a controller that is more robust to measurement noise.
 - 3 Specify your preference for controller order using the **Desired controller order** slider.
 - 4 Click **Update Compensator**.

Loop Shaping

Loop shaping generates a stabilizing feedback controller to match as closely as possible to a desired loop shape. You can specify this loop shape as a bandwidth or an open loop frequency response. If you have Robust Control Toolbox™ software installed, you can use loop shaping for SISO systems. For more information see the section on H-Infinity Loop Shaping in the *Robust Control Toolbox User's Guide*.

To design a controller using loop shaping:

- 1 Select a tuning preference by clicking one of these option buttons:
 - **Target bandwidth** — Allows you to specify a target loop shape bandwidth (ω_b). This results in a loop shape of your specified bandwidth over an integrator ($\frac{\omega_b}{s}$).
 - **Target loop shape** — Allows you to specify the target open loop shape in one of the following representations: state-space, zero-pole-gain, or transfer functions.

2 Set the tuning options available for your selected tuning preference as follows:

- If you chose **Target bandwidth**, specify the desired **Target open-loop bandwidth** in the editable box.

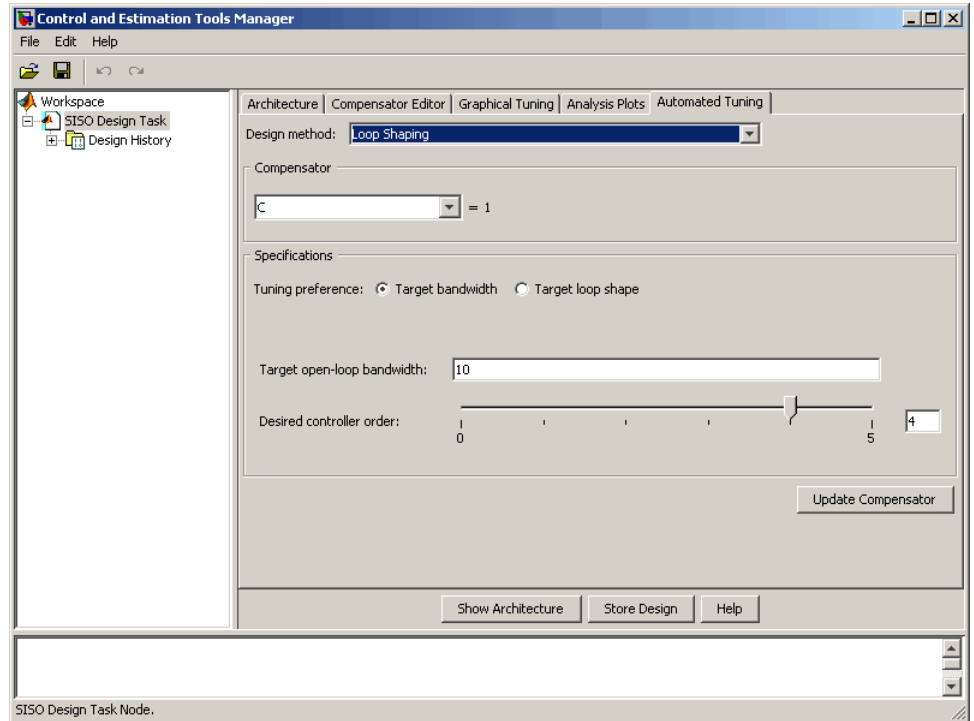

- If you chose **Target loop shape**, do the following:
 - Enter the desired **Target open-loop shape (LTI)**.
This can be a state-space representation, a zero-pole-gain representation, or a transfer function.
 - Enter the desired **Frequency range for loop shaping [wmin,wmax]**.

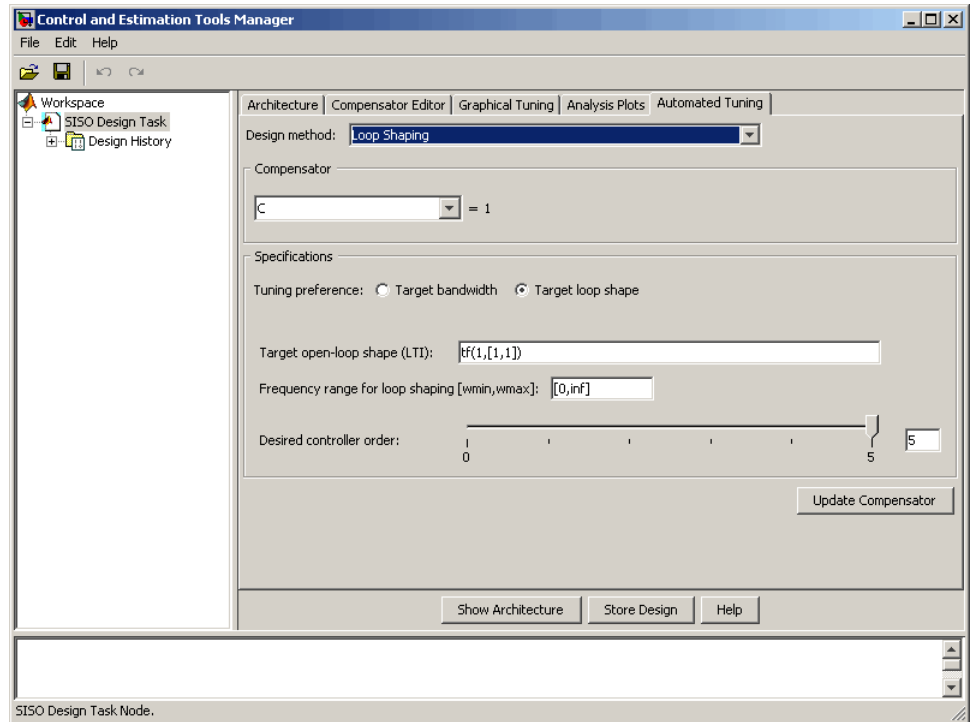

- 3** Specify your preference for controller order using the **Desired controller order** slider.
- 4** Click **Update Compensator**.

SISO Design Task Graphical Tuning Window

This picture shows the Graphical Tuning window and introduces some terminology.

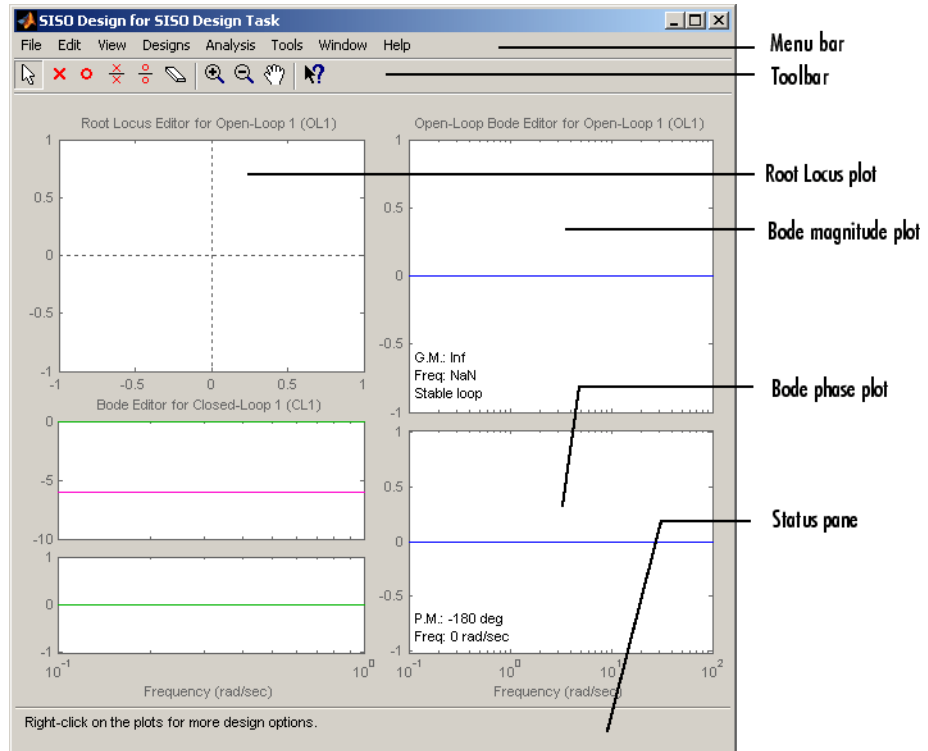

Graphical Tuning Window

This section describes the Graphical Tuning window features left-to-right and top-to-bottom, starting with the menu bar and ending with the status pane at the bottom of the window.

Using the Graphical Tuning Window Menu Bar

In this section...

“Overview of the Graphical Tuning Window Menu Bar” on page 11-41

“File” on page 11-41

“Edit” on page 11-44

“View” on page 11-45

“Analysis” on page 11-46

“Tools” on page 11-47

“Window” on page 11-51

“Help” on page 11-51

Overview of the Graphical Tuning Window Menu Bar

Several of the tasks you can do in the SISO Design Tool can be done from the menu bar, shown below.

File Edit View Designs Analysis Tools Window Help

File

Import...	
Export...	
Save Session...	
Load Session...	
Toolbox Preferences...	
Print...	Ctrl+P
Print to Figure	
Close	Ctrl+W

Using the **File** menu, you can:

- Import and export models

- Save and reload sessions
- Set toolbox preferences
- Print and print to figure
- Close the Graphical Tuning Window

The following sections describe the **File** menu options in turn.

Import

Selecting **Import** opens the same System Data dialog box that clicking **System Data** on the **Architecture** pane does. See “Importing Models” on page 11-15.

Export

Selecting **Export** from the Graphical Tuning window **File** menu opens the same SISO Tool Export window that selecting **Export** from the SISO Design Task node **File** menu does. See Export.

Save Session

Selecting **Save Session** from the Graphical Tuning window **File** menu opens the same Save Projects window that selecting **Save** from the SISO Design Task node **File** menu does. See Save.

Load Session

To load a saved SISO Design Tool session, select **Load Session** from the **File** menu. This opens the **Load Session** menu.

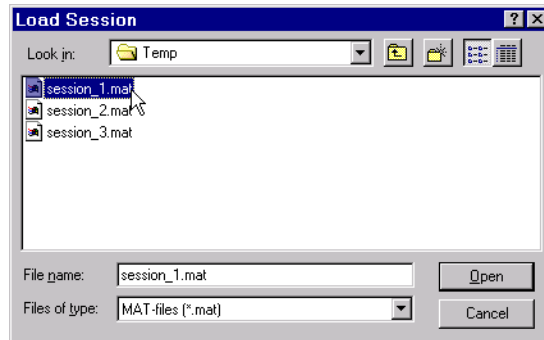

Sessions are saved as MAT-files. Select the session you want to load from the list, and click **Open**. See “Save Session” on page 11-42 for information on saving **SISO Design Tool** sessions.

Toolbox Preferences

Select **Toolbox Preferences** from the **File** menu to open the **Control System Toolbox Preferences** menu.

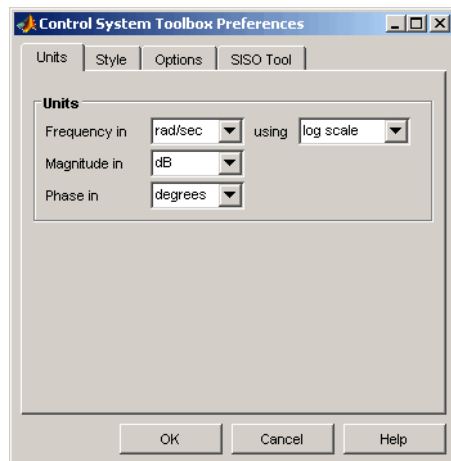

The Control System Toolbox Preferences Window

For a discussion of this window’s features, see "Setting Toolbox Preferences" online in the Control System Toolbox documentation.

Print

Use **Print** to send a picture of the Graphical Tuning window to your printer.

Print to Figure

Print to Figure opens a separate figure window containing the design views in your current Graphical Tuning window.

Close

Use **Close** to close the Graphical Tuning window.

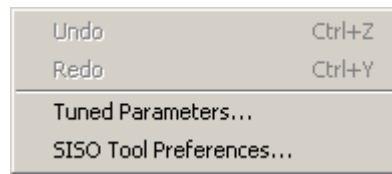
Edit**Undo and Redo**

Selecting **Undo** and **Redo** perform the same actions as selecting **Undo** and **Redo** from the **SISO Design Task Node Edit** menu. See “**Edit Menu Options**” on page 11-8.

Tuned Parameters

Selecting **Tuned Parameters** opens the SISO Tool Preferences dialog box on the **Options** page.

SISO Tool Preferences

Selecting the **SISO Tool Preferences** option opens the same dialog box that selecting SISO Tool Preferences from the Edit menu on the SISO Design Task Node. See “**Edit Menu Options**” on page 11-8.

View

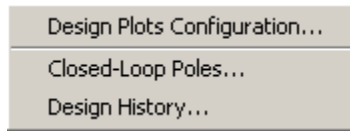

Design Plots Configuration

Select **Design Plots Configuration** to open the Graphical Tuning pane. See “Graphical Tuning” on page 11-18.

Closed-Loop Poles

Select **Closed-Loop Poles** from **View** to open the **Closed-Loop Pole Viewer**.

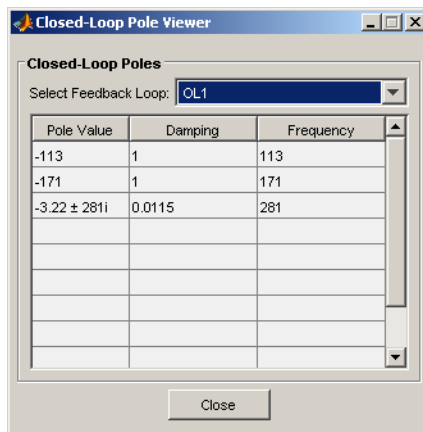

This window displays all the closed-loop pole values of the selected feedback loop and the associated damping and frequency values.

Design History

Select **Design History** from the **View** menu to open the **Design History** window, which displays all the actions you’ve performed during a design session. You can save the history to an ASCII flat text file by clicking **Save to Text File**.

Analysis

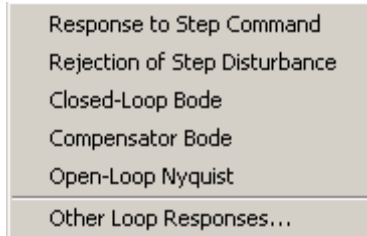

Common Response Plots

Each of the top group of items in the Analysis menu opens an LTI Viewer that is dynamically linked to your SISO Design Tool. You have the following response plot choices:

- **Response to Step Command** — The closed-loop step response of your system
- **Rejection of Step Disturbance** — The open-loop step response of your system
- **Closed-Loop Bode** — The closed-loop Bode diagram for your system
- **Compensator Bode** — The open-loop Bode diagram for your compensator
- **Open-Loop Nyquist** — The open-loop Nyquist plot for your system

When you make changes to the design via the Graphical Tuning window, the Compensator Editor pane, or the Automated Tuning pane, the response plots in the LTI Viewer automatically change to reflect the new design's responses.

Other Loop Responses

If you choose **Other Loop Responses**, the **Analysis Plots** pane opens. See "Analysis Plots" on page 11-21.

Tools

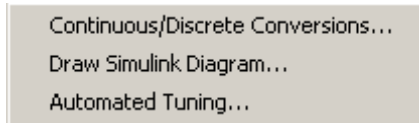

Continuous/Discrete Conversions Using the Sample Time Conversion Dialog Box

- “Converting Continuous-Time Models to Discrete-Time Models” on page 11-47
- “Converting Discrete-Time Models to Continuous-Time” on page 11-48
- “Changing the Sample Time of a Discrete-Time Model” on page 11-49

Converting Continuous-Time Models to Discrete-Time Models. To convert a continuous-time model to a discrete-time model, perform these steps:

- 1 In the SISO Design Tool, select **Tools > Continuous/Discrete Conversions** to open the **Sample Time Conversion** window.

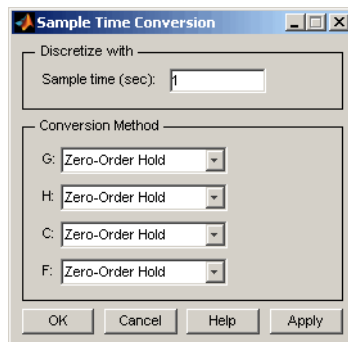

- 2 Specify a positive number for the sample time in the **Sample time (sec)** field.
- 3 Select a continuous-to-discrete conversion method for each component of your model. The components include the plant (**G**), the compensator (**C**), the prefilter (**F**), or the sensor (**H**). You can choose from the following conversion methods:

- Zero-order hold
- First-order hold
- Tustin
- Tustin with prewarping

Note If you choose Tustin with prewarping, you must specify the critical frequency in radians per second.

- Matched pole/zero

For more information on each of these conversion methods, see “Supported Conversion Functions and Methods” in the Control System Toolbox documentation.

Converting Discrete-Time Models to Continuous-Time. To convert a discrete-time model to a continuous-time model, perform these steps:

- 1 In the SISO Design Tool, select **Tools > Continuous/Discrete Conversions** to open the **Sample Time Conversion** window.

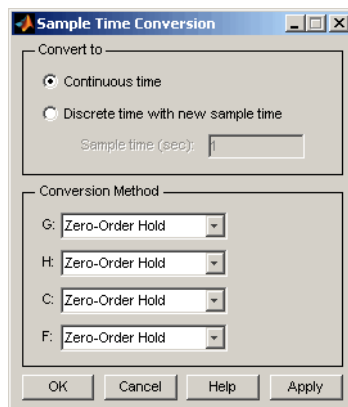

- 2 Select a discrete-to-continuous conversion method for each component of your model. The components include the plant (**G**), the compensator (**C**),

the prefilter (**F**), or the sensor (**H**). You can choose from the following conversion methods:

- Zero-order hold
- First-order hold
- Tustin
- Tustin with prewarping

Note If you choose Tustin with prewarping, you must specify the critical frequency in radians per second.

- Matched pole/zero

For more information on each of these conversion methods, see “Supported Conversion Functions and Methods” in the Control System Toolbox documentation.

Changing the Sample Time of a Discrete-Time Model. To change the sample time of (resample) a discrete system, perform these steps:

- 1** In the SISO Design Tool, select **Tools > Continuous/Discrete Conversions** to open the **Sample Time Conversion** window.
- 2** Click the **Discrete time with new sample time** option button.

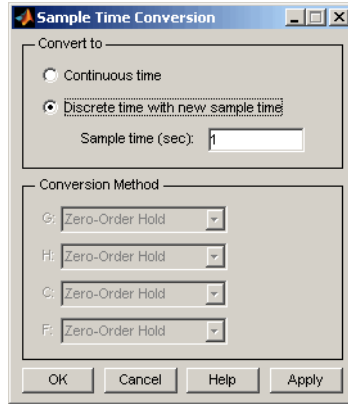

- 3 Specify a positive number for the sample time in the **Sample time (sec)** field.

Draw Simulink Diagram

Note You must have a license for Simulink to use this feature. If you do not have Simulink, this option does not appear under the **Tools** menu.

Select **Draw Simulink Diagram** from the Tools menu to draw a block diagram of your system (plant, compensator, prefilter, and sensor). The following diagram shows how the tool would render the DC motor example described in the *Control System Toolbox Getting Started Guide*.

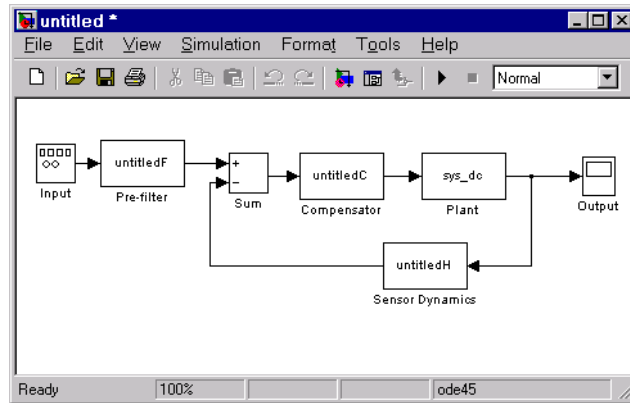

Automated Tuning

Select **Automated Tuning** from the Tools menu in the SISO Design Tool to open the **Automated Tuning** tab of the Control and Estimation Tools Manager. You can use this tab to perform automated tuning of compensators. For more information, see “Automated Tuning Design”.

Window

The **Window** menu item lists all window open in the MATLAB technical computing environment. The first item is always the MATLAB Command Window. After that, windows you have opened are listed in the order in which you invoked them. Any window you select from the list become the active window.

Help

Help brings you to various places in the Control System Toolbox help system. This figure shows the menu.

SISO Design Tool Help
Control System Toolbox Help
<u>W</u> hat's This?
Importing/Exporting Models
Tuning <u>C</u> ompensators
Viewing Loop <u>R</u> esponses
<u>V</u> iewing System Data
<u>S</u> toring/Retrieving Designs
Customizing the SISO Tool
<u>D</u> emos
<u>A</u> bout the Control System Toolbox

Each topic takes you to brief discussions of basic information about the SISO Design Tool and the Control System Toolbox software:

- **SISO Design Tool Help** — An overview of the SISO Design Tool
- **Control System Toolbox Help** — A roadmap for the Control System Toolbox help
- **What's This?** — Activates the "What's This?" cursor, which appears as a question mark. Click in various regions of the SISO Design Tool to see brief descriptions of the tool's features.
- **Importing/Exporting Models** — How to import models into the SISO Design Tool and how to export completed designs
- **Tuning Compensators** — Basic information about adjusting gains and adding dynamics to your prefilter (**F**) and compensator (**C**)
- **Viewing Loop Responses** — How to open an LTI Viewer containing loop responses for your system. Many response types are available.
- **Viewing System Data** — How to see information about your model
- **Storing/Retrieving Designs** — How to store and retrieve designed systems
- **Customizing the SISO Tool** — How to open the SISO Tool Preferences editor, which allows you to customize plot displays in the tool
- **Demos** — A link to Control System Toolbox demos
- **About the Control System Toolbox software** — The version number of your Control System Toolbox software

Using the Graphical Tuning Window Toolbar

The toolbar performs the following operations:

- Add and delete real and complex poles and zeros
- Zoom in and out
- Invoke the SISO Design Tool's context-sensitive help

This picture shows the toolbar.

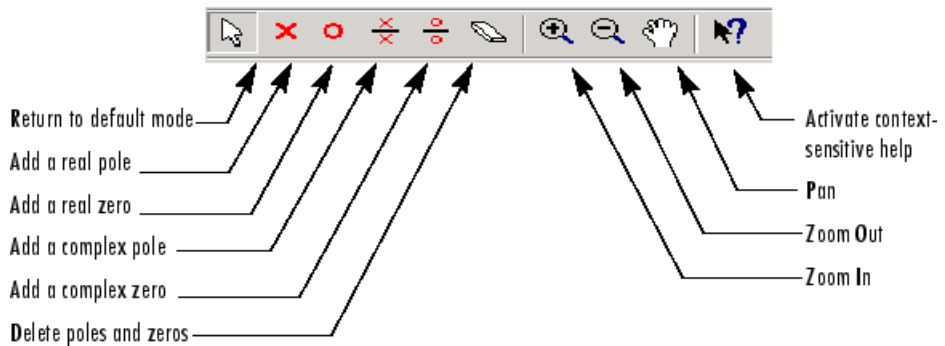

Options Available from the Toolbar

You can use the tool tips feature to find out what a particular icon does. Just place your mouse over the icon in question, and you will see a brief description of what it does.

Once you've selected an icon, your mouse stays in that mode until you press the icon again.

You can reach all of these options from the right-click menus.

Using the Right-Click Menus in the Graphical Tuning Window

In this section...

“Overview of the Right-Click Menus” on page 11-54

“Add Pole/Zero” on page 11-55

“Delete Pole/Zero” on page 11-58

“Edit Compensator” on page 11-58

“Gain Target” on page 11-58

“Show” on page 11-58

“Design Requirements” on page 11-59

“Grid” on page 11-71

“Full View” on page 11-71

“Properties” on page 11-72

“Select Compensator” on page 11-73

“Status Pane” on page 11-73

Overview of the Right-Click Menus

The Graphical Tuning window provides right-click menus for all the views available. These views include the root-locus, open-loop Bode diagrams, Nichols plot, and the closed-loop Bode diagrams. The menu items in each of these views are identical. The design requirements, however, differ, depending on which view you are accessing the menus from.

You can use the right-click menu to design a compensator by adding poles, zeros, lead, lag, and notch filters. In addition, you can use this menu to add grids and zoom in on selected regions. Also, you can open each view’s **Property Editor** to customize units and other elements of the display.

Note Click items on the menu bar pictured below to get help contents.

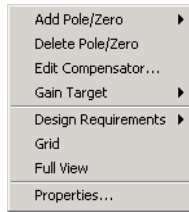

Open-Loop Right-Click Menu

Note that if you have a closed-loop response, the Gain Target menu item is replaced by “Select Compensator” on page 11-73.

Add Pole/Zero

The **Add Pole/Zero** menu options give you the ability to add dynamics to your compensator design, including poles, zeros, lead and lag networks, and notch filters. The following pole/zero configurations are available:

- **Real Pole**
- **Complex Pole**
- **Integrator**
- **Real Zero**
- **Complex Zero**
- **Differentiator**
- **Lead**
- **Lag**
- **Notch**

In all but the integrator and differentiator, once you select the configuration, your cursor changes to an 'x'. To add the item to your compensator design, place the x at the desired location on the plot and left-click your mouse. You will see the root locus design automatically update to include the new compensator dynamics.

The notch filter has three adjustable parameters. For a discussion about how to add and adjust notch filters, see "Adding a Notch Filter" in the *Control System Toolbox Getting Started Guide*.

Example: Adding a Complex Pair of Poles

This example shows you how to add a complex pair of poles to the open-loop Bode diagram. First, type

```
load ltexamples
sisotool('bode',sys_dc)
```

at the MATLAB prompt. This opens the SISO Design Tool with the DC motor example loaded and the open-loop Bode diagram displayed in the Graphical Tuning window.

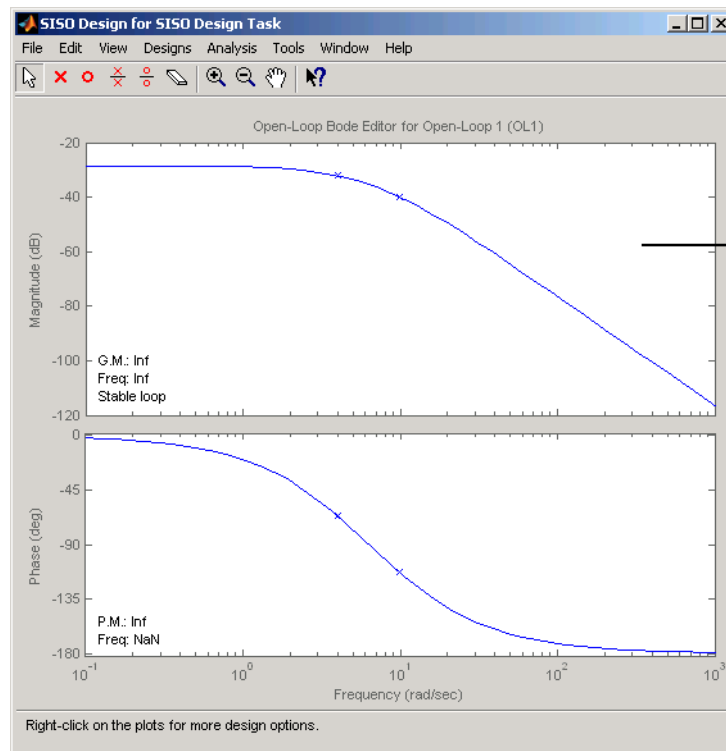

After selecting **Add Pole/Zero -> Complex Pole** from the right-click menu, use the mouse cursor to specify the frequency of the complex pole pair.

To add a complex pair of poles:

- 1** Select **Add Pole/Zero->Complex Pole** from the right-click menu
- 2** Place the mouse cursor where you want the pole to be located
- 3** Left-click to add the pole

Your Graphical Tuning window should look similar to this.

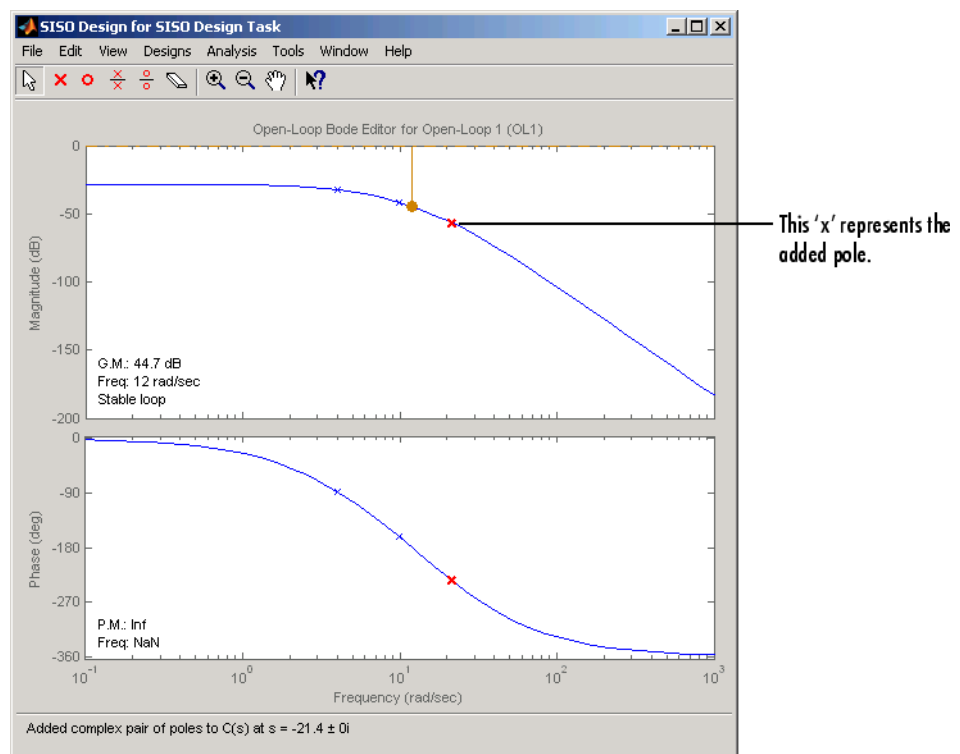

In the case of Bode diagrams, when you place a complex pole, the default damping value is 1, which means you have a double real pole. To change the damping, grab the red 'x' by left-clicking on it and drag it upward with your mouse. You will see damping ratio change in the Status pane at the bottom of the SISO Design Tool.

Delete Pole/Zero

Select **Delete Pole/Zero** to delete poles and zeros from your compensator design. When you make this selection, your cursor changes to an eraser. Place the eraser over the pole or zero you want to delete and left-click your mouse.

Note the following:

- You can only delete compensator poles and zeros. Plant (**G** in the feedback structure pane) poles and zeros cannot be altered.
- If you delete one of a pair of poles or zeros, the other member of the pair is also removed.

Edit Compensator

Edit Compensator opens the **Compensator Editor** pane in the SISO Design Task. You can use this pane to adjust the compensator gain and add or remove compensator poles and zeros from your compensator (**C**) or prefilter (**F**) design. See “Compensator Editor” on page 11-17 for a discussion of this pane.

Gain Target

This feature is intended for users of the Simulink® Control Design™ software. It is nonfunctional in the Control System Toolbox software.

Show

Use **Show** to select/deselect the display of characteristics relevant to which view you are working with. This figure displays the Show submenu for the open-loop Bode diagram.

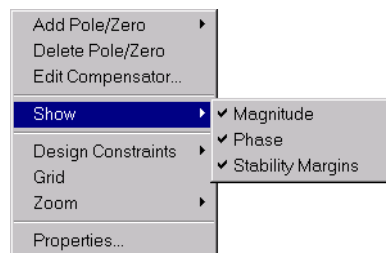

For this particular view, the options available are magnitude, phase, and stability margins. Selecting any of these toggles between showing and hiding the feature. A check next to the feature means that it is currently displayed on the Bode diagram plots. Although the characteristics are different for each view in the Graphical Tuning window, they all toggle on and off in the same manner.

Design Requirements

When designing compensators, it is common to have design specifications that call for specific settling times, damping ratios, and other characteristics. The Graphical Tuning window provides tools for design requirements that can help make the task of meeting design specifications easier. The New Design Requirement dialog box, which allows you to create design requirements by creating graphical representations for feasible and nonfeasible regions, automatically changes to reflect which design requirements are available for the view in which you are working. Select **Design Requirements > New** to open the New Design Requirement dialog box.

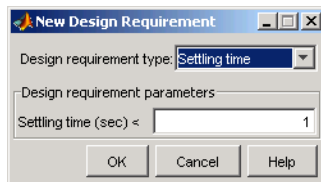

Since each view has a different set of design requirements, click the following links to go to the appropriate descriptions:

- “Design Requirements for the Root Locus” on page 11-59
- “Design Requirements for Open- and Closed-Loop Bode Diagrams” on page 11-63
- “Design Requirements for Open-Loop Nichols Plots” on page 11-66
- “LTI Viewer for SISO Design Task Design Requirements” on page 11-74

Design Requirements for the Root Locus

For the root locus, you can use the following design requirements:

- “Settling Time” on page 11-60
- “Percent Overshoot” on page 11-60
- “Damping Ratio” on page 11-60
- “Natural Frequency” on page 11-61
- “Region Constraint” on page 11-61

Use the **Design requirement type** drop-down list to select a design requirement. In each case, to specify the design requirement, enter the value in the **Design requirement parameters** pane. You can select any or all of them, or have more than one of each.

Settling Time. If you specify a settling time in the continuous-time root locus, a vertical line appears on the root locus plot at the pole locations associated with the settling time value provided (using a first-order approximation). This vertical line is exact for a second order system and is only an approximation for higher order systems. In the discrete-time case, the design requirement boundary is a curved line.

Percent Overshoot. Specifying percent overshoot in the continuous-time root locus causes two rays, starting at the root locus origin, to appear. These rays are the locus of poles associated with the percent value (using a second-order approximation). In the discrete-time case, the design requirement appears as two curves originating at (1,0) and meeting on the real axis in the left-hand plane.

Note that the percent overshoot (p.o.) design requirement can be expressed in terms of the damping ratio, as in this equation,

$$p.o. = 100e^{-\pi\zeta/\sqrt{1-\zeta^2}}$$

where ζ is the damping ratio.

Damping Ratio. Specifying a damping ratio in the continuous-time root locus causes two rays, starting at the root locus origin, to appear. These rays are the locus of poles associated with the damping ratio. In the discrete-time case, the design requirement boundary appears as curved lines originating at (1,0) and meeting on the real axis in the left-hand plane.

Natural Frequency. If you specify a natural frequency lower bound, a semicircle centered around the root locus origin appears. If you specify a natural frequency upper bound, the inverse of this semicircle appears. The radius equals the natural frequency.

Region Constraint. Specifying a region constraint at given locations causes black lines and a yellow area to appear. The vertices of this free-form piecewise region are defined by the specified real and imaginary values.

Example: Adding Damping Ratio Design Requirements

This example adds a damping ratio design requirement of 0.707.

- 1** At the MATLAB prompt, type the following:

```
load ltiexamples
sisotool(sys_dc)
```

This opens the SISO Design Tool with the DC motor example imported.

- 2** From the root locus right-click menu, select **Design Requirement > New** to open the New Design Requirement dialog box.
- 3** To add the design requirement, select **Damping Ratio** as the design requirement. Click **OK** to accept the default damping ratio of 0.707.

The Graphical Tuning window should now look similar to this figure.

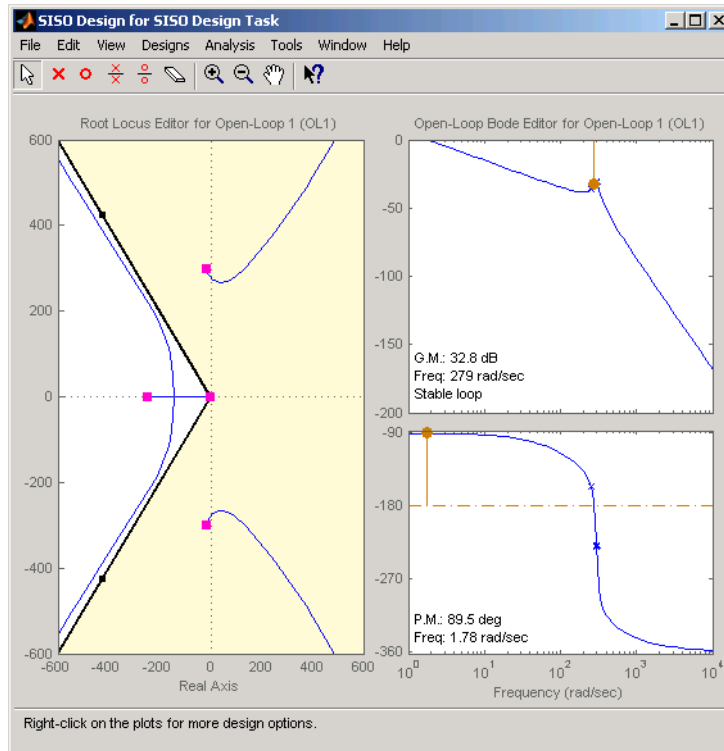

Damping Ratio Requirements in the Root Locus

The two rays centered at (0,0) represent the damping ratio boundaries. The dark edge is the region boundary, and the shaded area outlines the exclusion region. This figure explains what this means for this design requirement.

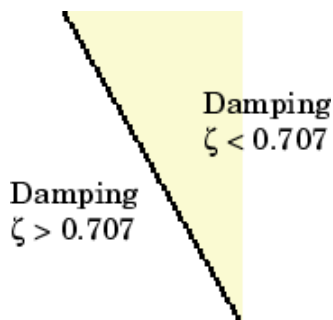

You can, for example, use this design requirement to ensure that the closed-loop poles, represented by the red squares, have some minimum damping. Try adjusting the gain until the damping ratio of the closed-loop poles is 0.7.

Design Requirements for Open- and Closed-Loop Bode Diagrams

For both the open- and closed-loop Bode diagrams, you have the following options:

- “Upper Gain Limit” on page 11-63
- “Lower Gain Limit” on page 11-63
- “Gain and Phase Margin” on page 11-63

Specifying any of these design requirements causes lines to appear in the Bode magnitude curve. To specify an upper or lower gain limit, enter the frequency range, the magnitude limit, and/or the slope in decibels per decade, in the appropriate fields of the New design requirement dialog box. You can have as many gain limit design requirements as you like in your Bode magnitude plots.

Upper Gain Limit. You can specify one or multiple piecewise linear upper gain limits over a frequency range, which appear as straight lines on the Bode magnitude curve. You must select frequency limits, the upper gain limit in decibels, and the slope in dB/decade.

Lower Gain Limit. You can specify one or multiple lower gain limit in the same fashion as the upper gain limit.

Gain and Phase Margin. You can specify a lower bound for the gain, the phase margin, or both. The specified bounds appear in text on the Bode magnitude plot.

Example: Adding Upper Gain Limits

This example shows you how to add two upper gain limit requirements to the open-loop Bode diagram.

- 1 At the MATLAB prompt, type the following:

```
load ltiexamples
sisotool('bode', Gservo)
```

This opens the SISO Design Tool with the servomechanism model loaded.

- 2 Use the right-click menu to add a grid.

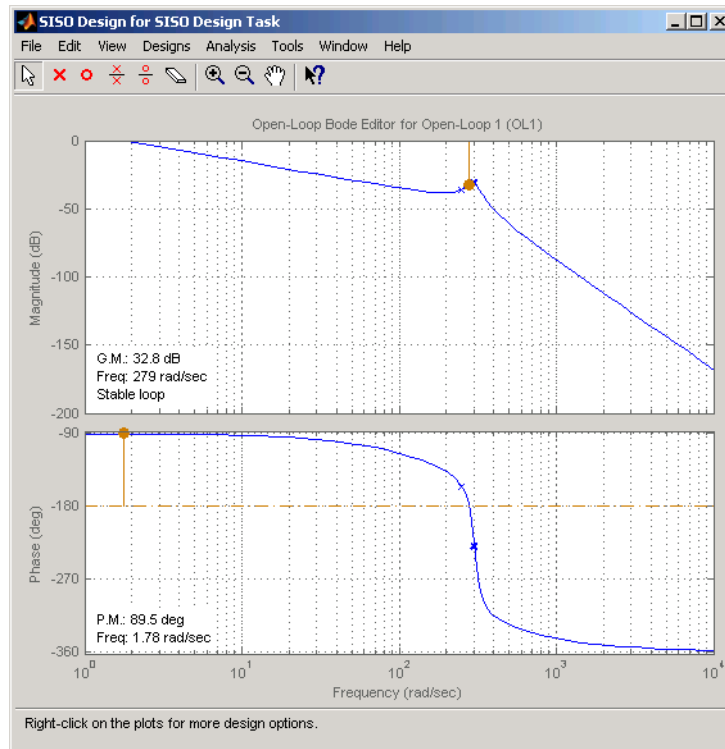

- 3 To add an upper gain limit requirement of 0 dB from 10 rad/sec to 100 rad/sec, open the New Design Requirement dialog box and select **Upper gain limit** from the pull-down menu. Fill in the dialog box fields as shown in the following figure.

Your Graphical Tuning window should now look like this (you may have to adjust some axis limits).

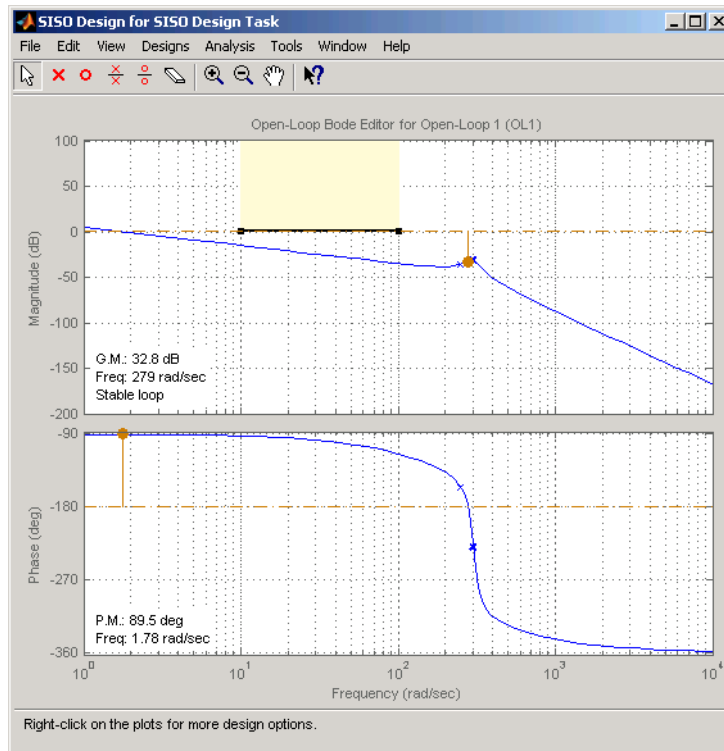

- 4 To constrain the roll off, open the New Design Requirement dialog box and add an upper gain limit from 100 rad/sec to 1000 rad/sec with a slope of -20 db/decade. This figure shows the result.

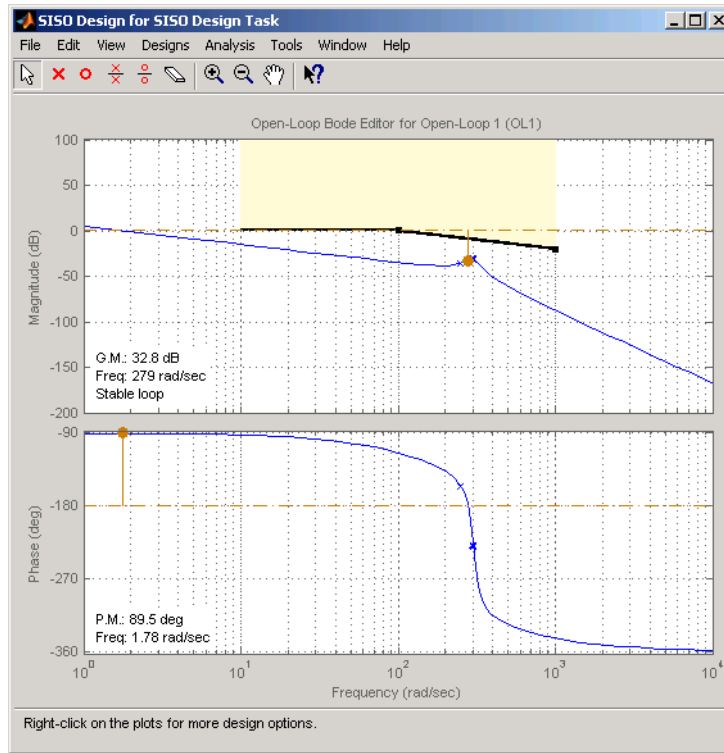

With these design requirements in place, you can see how much you can increase the compensator gain and still meet design specifications.

Note that you can change the design requirements by moving them with your mouse. See “Editing Design Requirements” on page 11-69 for more information.

Design Requirements for Open-Loop Nichols Plots

For open-loop Nichols plots, you have the following design requirement options:

- “Phase Margin” on page 11-67
- “Gain Margin” on page 11-67

- “Closed-Loop Peak Gain” on page 11-67
- “Gain-Phase Design Requirement” on page 11-67

Specifying any of these design requirements causes lines or curves to appear in the Nichols plot. In each case, to specify the design requirement, enter the value in the **Design requirement parameters** pane. You can select any or all of them, or have more than one of each.

Phase Margin. Specify a minimum phase margin at a given location. For example, you can require a minimum of 30 degrees at the -180 degree crossover. The phase margin specified should be a number greater than 0. The location must be a -180 plus a multiple of 360 degrees. If you enter an invalid location point, the closest valid location is selected.

Gain Margin. Specify a gain margin at a given location. For example, you can require a minimum of 20 dB at the -180 degree crossover. The location must be -180 plus a multiple of 360 degrees. If you enter an invalid location point, the closest valid location is selected.

Closed-Loop Peak Gain. Specify a peak closed-loop gain at a given location. The specified dB value can be positive or negative. The design requirement follows the curves of the Nichols plot grid, so it is recommended that you have the grid on when using this feature.

Gain-Phase Design Requirement. Specify both a gain and phase design requirement at a given location. The vertices of this free-form piecewise region are defined by the specified open-loop phase and open-loop gain values.

Example: Adding a Closed-Loop Peak Gain Design Requirement

This example shows how to add a closed-loop peak gain design requirement to the Nichols plot.

1 At the MATLAB prompt, type the following:

```
load ltiexamples
sisotool('nichols',Gservo)
```

This opens the SISO Design Tool with Gservo imported as the plant.

- 2 Use the right-click menu to add a grid, as this figure shows.

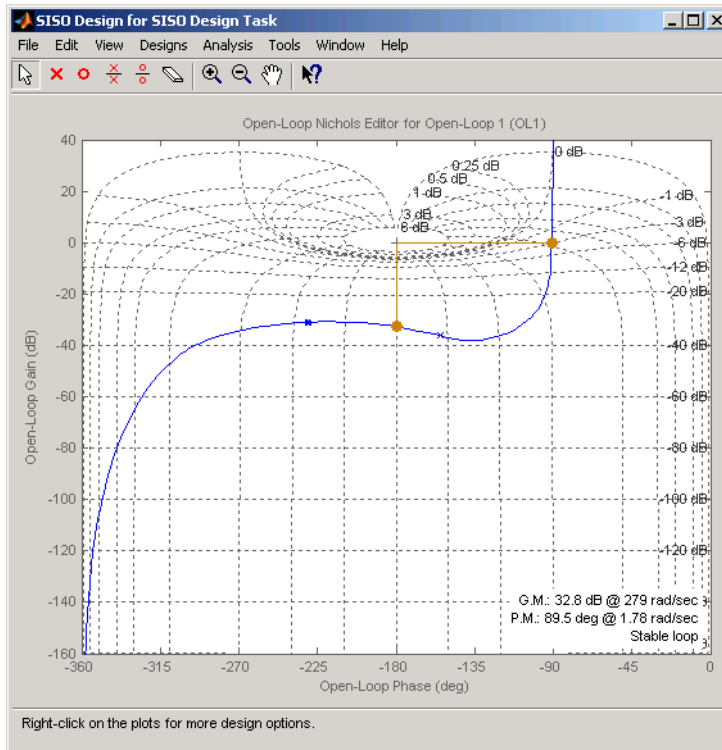

- 3 To add closed-loop peak gain of 1 dB at -180 degrees, open the New Design Requirement dialog box and select **Closed-Loop Peak Gain** from the pull-down menu. Set the peak gain field to 1 dB.

The figure shows the resulting design requirement.

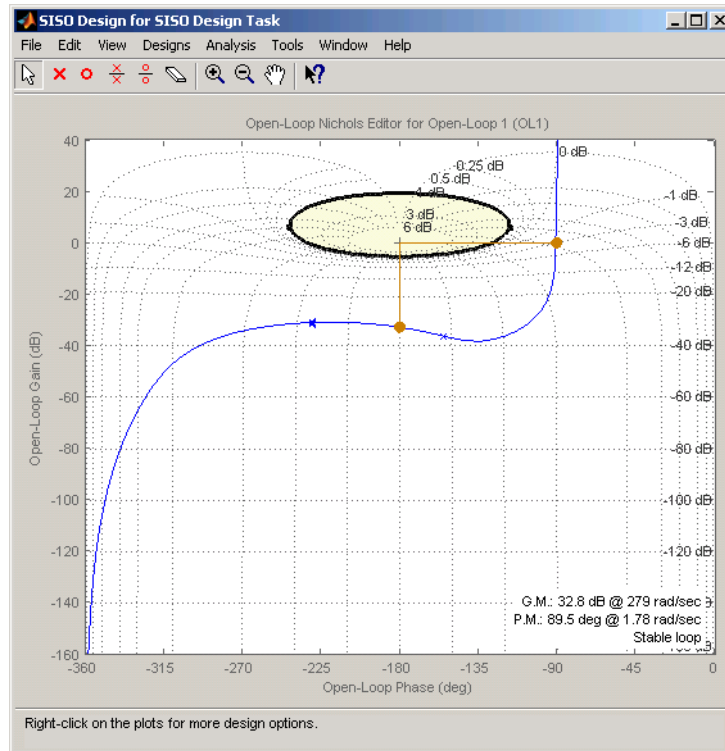

As long as the curve is outside of the gray region, the closed-loop gain is guaranteed to be less than 1 dB. Note that this is equivalent, up to second order, to specifying the peak overshoot in the time domain. In this case, a 1 dB closed-loop peak gain corresponds to an overshoot of 15%.

Editing Design Requirements

To edit an existing design requirement, left-click on the design requirement boundary to select it. Two black squares appear on the design requirement when it is selected. In general, there are two ways to adjust a design requirement:

- Click on the design requirement boundary and drag it. Generally, this does not change the shape of the boundary. That is, the adjustment is strictly a translation of the design requirement.

- Grab a black square and drag it. In this case, you can rotate, expand, and/or contract the design requirement.

For example, in Bode diagrams you can move an upper gain limit by clicking on it and moving it anywhere in the plot region. As long as you haven't grabbed a black square, the length and slope of the gain limit will not change as you move the line. On the other hand, you can change the slope of the upper gain limit by grabbing one of the black squares and rotating the line. In all cases, the Status pane at the bottom of the Graphical Tuning window displays the design requirement values as they change.

This figure shows the process of editing an upper gain limit in the open-loop Bode diagram.

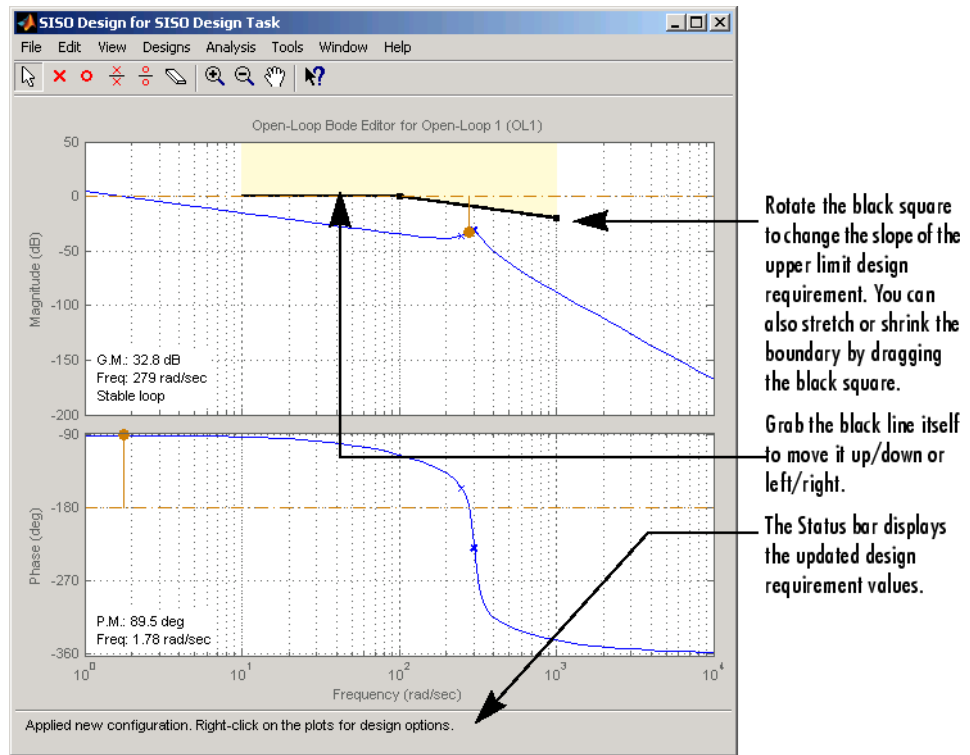

An alternative way to adjust a design requirement is to select **Design Requirements->Edit** from the right-click menu. The **Edit Design Requirement** window opens.



To adjust a design requirement, select the boundary by clicking on it and change the values in the fields of the Design requirement parameters pane. If you have additional design requirement in, for example, the Bode diagram, you can edit them directly from this window by selecting **Open-Loop Bode** from the **Editor** menu.

Deleting Design Requirements

To delete a design requirement, place your cursor directly over the design requirement yellow region. Right-click to open a menu containing **Edit** and **Delete**. Select **Delete** from the menu list; this eliminates the design requirement. You can also delete design requirements by left-clicking on a design requirement boundary and then pressing the **BackSpace** or **Delete** key on your keyboard.

Finally, you can delete design requirements by selecting **Undo Add Design Requirement** from the **Edit** menu, or pressing **Ctrl+Z** if adding design requirements was the last action you took.

Grid

Grid adds a grid to the selected plot.

Full View

Selecting **Full View** causes the plot to scale limits so that the entire curve is visible.

Properties

Properties opens the **Property Editor**, which is a GUI for customizing root locus, Bode diagrams, and Nichols plots inside the Graphical Tuning window. The Property Editor automatically reconfigures as you select among the different plots open.

This picture shows the open window for the root locus.

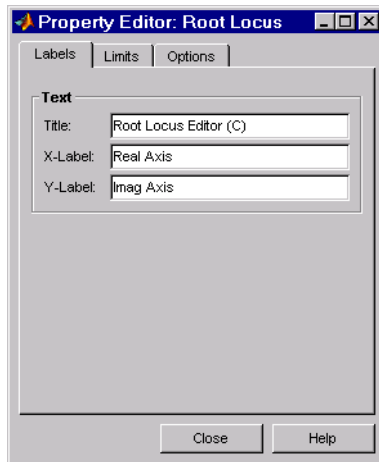

You can use this window to change titles and axis labels, reset axes limits, add grid lines, and change the aspect ratio of the plot. Note that you can also activate this menu by double-clicking anywhere in the root locus away from the curve.

There are only three panes in the Property Editor: Labels, Limits, and Options. The configuration of each page differs, depending on whether you're working with the root-locus, Bode diagrams, or the open-loop Nichols plot. Click the **Help** button on the Property Editor you have open to view information specific to that editor, or click on the links below:

- Root locus
- Bode diagram
- Nichols plot

Select Compensator

This option allows you to select which compensator to edit for closed-loop Bode response.

Status Pane

The Status pane is located at the bottom of the Graphical Tuning window. It displays the most recent action you have performed, occasionally provides advice on how to use the window, and tracks key parameters when moving objects in the design views.

LTI Viewer for SISO Design Task Design Requirements

In this section...

“Overview of LTI Viewer Design Requirements” on page 11-74

“Available Design Requirements in the LTI Viewer” on page 11-74

“Example: Time Domain Requirement” on page 11-75

Overview of LTI Viewer Design Requirements

You can use the LTI Viewer for SISO Design Tasks to specify both time and frequency domain requirements in analysis plots. Adding and editing design requirements is similar to those illustrated in the Graphical Tuning window.

Available Design Requirements in the LTI Viewer

The design requirements for Bode, Root Locus, and Nichols plots can be applied to both graphical tuning windows and the LTI viewer. See “Design Requirements” on page 11-59 for information on graphical tuning design requirements.

You can also use the following design requirements for both step and impulse response plots:

- **Upper time response bounds** — Creates an upper amplitude bound for a specified time duration.
- **Lower time response bounds** — Creates a lower amplitude bound for a specified time duration.

If you are using a step response plot, you can also use the following design requirement:

- **Step response bounds** — Creates a group of upper and lower time response bounds, in the shape of a step response envelope, to encompass your specified design requirement parameters.

Example: Time Domain Requirement

This example shows you how to create a lower bound time response design requirement.

- 1 At the MATLAB prompt, type the following:

```
load ltiexamples
sisotool(Gservo)
```

- 2 From the **Analysis Plot** pane, select step response. See “Analysis Plots” on page 11-21 if you are unfamiliar with this task.
- 3 Select Design Requirements->New from the LTI Viewer right-click menu.
- 4 Select Lower time response bound from the Design requirements menu.
- 5 Set Time from 0.1 to 0.5 s.
- 6 Set Amplitude from 0 to 0.8. Your New Design Requirement window should look like this.

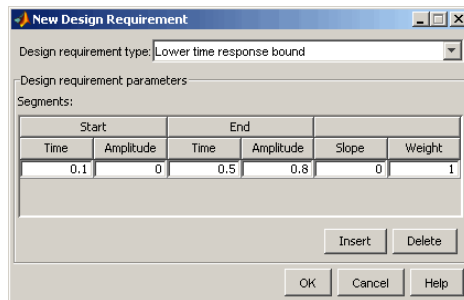

- 7 Click OK. This adds the design requirement. Your step response should look like this.

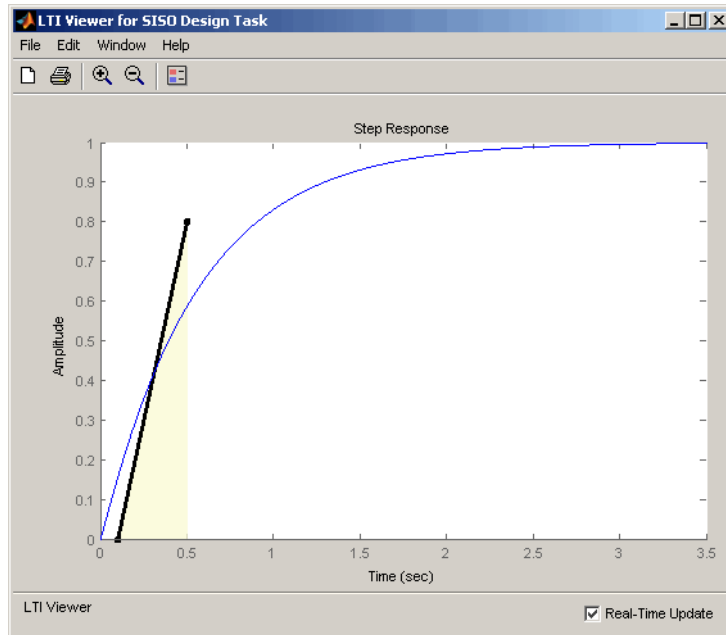

LTI Viewer

- “Basic LTI Viewer Tasks” on page 12-2
- “Using the Right-Click Menu in the LTI Viewer” on page 12-4
- “Importing, Exporting, and Deleting Models in the LTI Viewer” on page 12-12
- “Selecting Response Types” on page 12-16
- “Analyzing MIMO Models” on page 12-20
- “Customizing the LTI Viewer” on page 12-25

Basic LTI Viewer Tasks

LTI Viewer is a graphical user interface (GUI) that simplifies the analysis of linear, time-invariant systems. You use the LTI Viewer to view and compare the response plots of SISO and MIMO systems, or of several linear models at the same time. You can generate time and frequency response plots to inspect key response parameters, such as rise time, maximum overshoot, and stability margins.

The easiest way to work with the LTI Viewer is to use the right-click menus. For example, type

```
load ltiexamples
ltiview(sys_dc)
```

at the MATLAB prompt. The default plot is a step response.

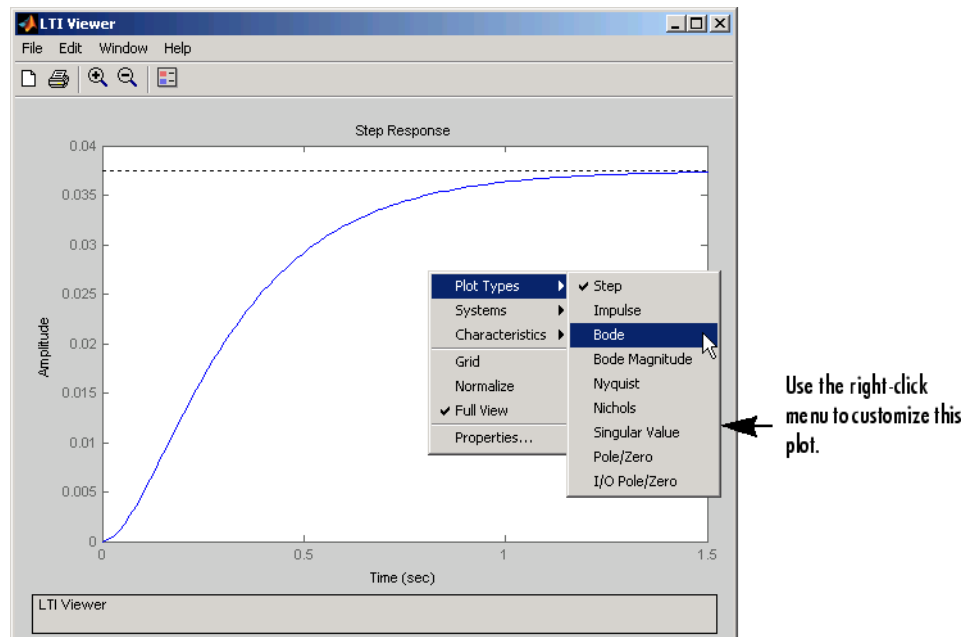

The LTI Viewer can display up to seven different plot types simultaneously, including step, impulse, Bode (magnitude and phase or magnitude only), Nyquist, Nichols, sigma, pole/zero, and I/O pole/zero.

See `ltiview` for help on the function that opens an LTI Viewer. For examples of how to use the LTI Viewer, see Analyzing Models in the *Control System Toolbox Getting Started Guide*.

Using the Right-Click Menu in the LTI Viewer

In this section...

“Overview of the Right-Click Menu” on page 12-4

“Setting Characteristics of Response Plots” on page 12-4

“Adding Design Requirements” on page 12-9

Overview of the Right-Click Menu

The quickest way to manipulate views in the LTI Viewer is use the right-click menu. You can access several LTI Viewer controls and options, including:

- **Plot Type** — Changes the plot type
- **Systems** — Selects or deselects any of the models loaded in the LTI Viewer
- **Characteristics** — Displays key response characteristics and parameters
- **Grid** — Adds grids to your plot
- **Properties** — Opens the **Property Editor**, where you can customize plot attributes
- **Design Requirements** — Opens the New Design Requirement window for adding step response design requirements to your plot (available only for LTI Viewers linked to the Graphical Tuning window of the SISO Design Tool)

In addition to right-click menus, all response plots include data markers. These allow you to scan the plot data, identify key data, and determine the source system for a given plot.

Setting Characteristics of Response Plots

The **Characteristics** menu changes for each plot response type. Characteristics refers to response plot information, such as peak response, or, in some cases, rise time and settling time.

The next sections describe the menu items for each of the eight plot types.

Step Response

Step plots the model's response to a step input.

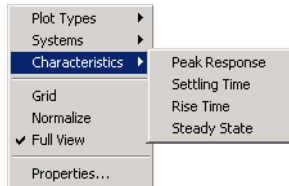

You can display the following information in the step response:

- **Peak Response** — The largest deviation from the steady-state value of the step response
- **Settling Time** — The time required for the step response to decline and stay at 5% of its final value
- **Rise Time** — The time require for the step response to rise from 10% to 90% of its final value
- **Steady-State** — The final value for the step response

Note You can change the definitions of settling time and rise time using the **Characteristics** pane of the Control System Toolbox editor, the LTI Viewer editor, or the Property editor.

Impulse Response

Impulse Response plots the model's response to an impulse.

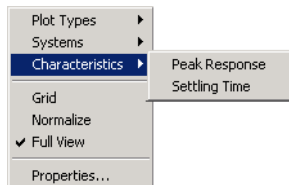

The LTI Viewer can display the following information in the impulse response:

- **Peak Response** — The maximum positive deviation from the steady-state value of the impulse response
- **Settling Time** — The time required for the step response to decline and stay at 5% of its final value

Bode Diagram

Bode plots the open-loop Bode phase and magnitude diagrams for the model.

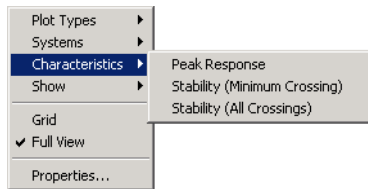

The LTI Viewer can display the following information in the Bode diagram:

- **Peak Response** — The maximum value of the Bode magnitude plot over the specified region
- **Stability Margins (Minimum Crossing)** — The minimum phase and gain margins. The gain margin is defined to the gain (in dB) when the phase first crosses -180° . The phase margin is the distance, in degrees, of the phase from -180° when the gain magnitude is 0 dB.
- **Stability Margins (All Crossings)** — Display all stability margins

Bode Magnitude

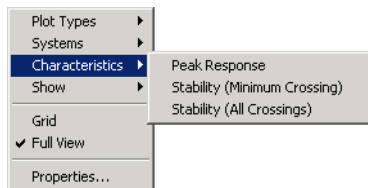

Bode Magnitude plots the Bode magnitude diagram for the model.

The LTI Viewer can display the following information in the Bode magnitude diagram:

- **Peak Response**, which is the maximum value of the Bode magnitude in decibels (dB), over the specified range of the diagram.
- **Stability (Minimum Crossing)** — The minimum gain margins. The gain margin is defined to the gain (in dB) when the phase first crosses -180° .
- **Stability (All Crossings)** — Display all gain stability margins

Nyquist Diagrams

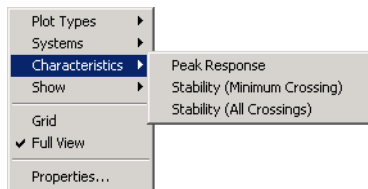

Nyquist plots the Nyquist diagram for the model.

The LTI Viewer can display the following types of information in the Nyquist diagram:

- **Peak Response** — The maximum value of the Nyquist diagram over the specified region
- **Stability (Minimum Crossing)** — The minimum gain and phase margins for the Nyquist diagram. The gain margin is the distance from the origin to the phase crossover of the Nyquist curve. The phase crossover is where the curve meets the real axis. The phase margin is the angle subtended by the real axis and the gain crossover on the circle of radius 1.
- **Stability (All Crossings)** — Display all gain stability margins

Nichols Charts

Nichols plots the Nichols Chart for the model.

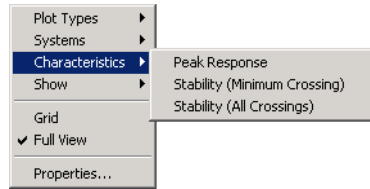

The LTI Viewer can display the following types of information in the Nichols chart:

- **Peak Response** — The maximum value of the Nichols chart in the plotted region.
- **Stability (Minimum Crossing)** — The minimum gain and phase margins for the Nichols chart.
- **Stability (All Crossings)** — Display all gain stability margins

Singular Values

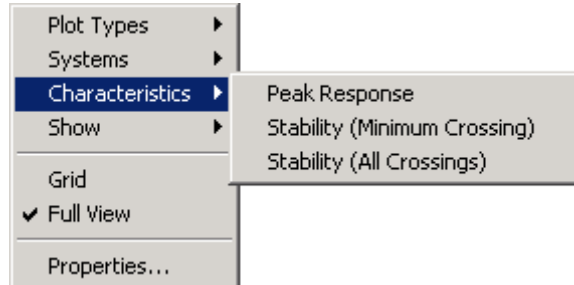

Singular Values plots the singular values for the model.

The LTI Viewer can display the **Peak Response**, which is the largest magnitude of the Singular Values curve over the plotted region.

Pole/Zero and I/O Pole/Zero

Pole/Zero plots the poles and zeros of the model with 'x' for poles and 'o' for zeros. I/O Pole/Zero plots the poles and zeros of I/O pairs.

There are no **Characteristics** available for pole-zero plots.

Adding Design Requirements

If you open an LTI Viewer for the Graphical Tuning window, you have plots linked to your compensator design. In this environment, the LTI Viewer provides access to design requirements, a set of graphical tools for creating constraints in your design plots.

In addition to all the design requirements available in the Graphical Tuning window, the LTI Viewer has step response design requirements, which are described below. For a discussion of all others, see “Design Requirements” on page 11-59.

Note Design Requirements are not available from an LTI Viewer that is not linked to the Graphical Tuning window.

Choosing Step Response Specifications

To specify step response characteristics select **Design Requirements > New** in the right-click menu. This will display the **New Design Requirements** editor. Select **step response bounds** from the **Design requirement type** pull down menu to display the step response specifications as shown below.

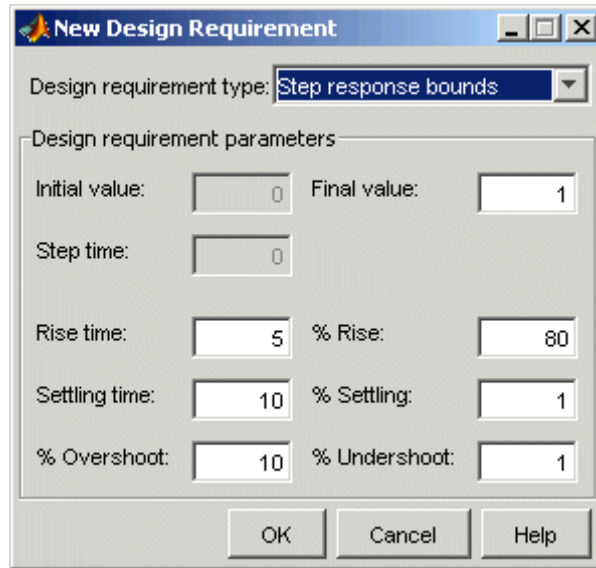

The top three options specify the details of the step input:

- **Initial value:** input level before the step occurs. This option is grayed out because LTI systems always have initial value equal to 0.
- **Step time:** time at which the step takes place. This option is grayed out since LTI systems always have an initial time equal to 0.
- **Final value:** input level after the step occurs

The remaining options specify the characteristics of the response signal. Each of the step response characteristics is described in the figure below.

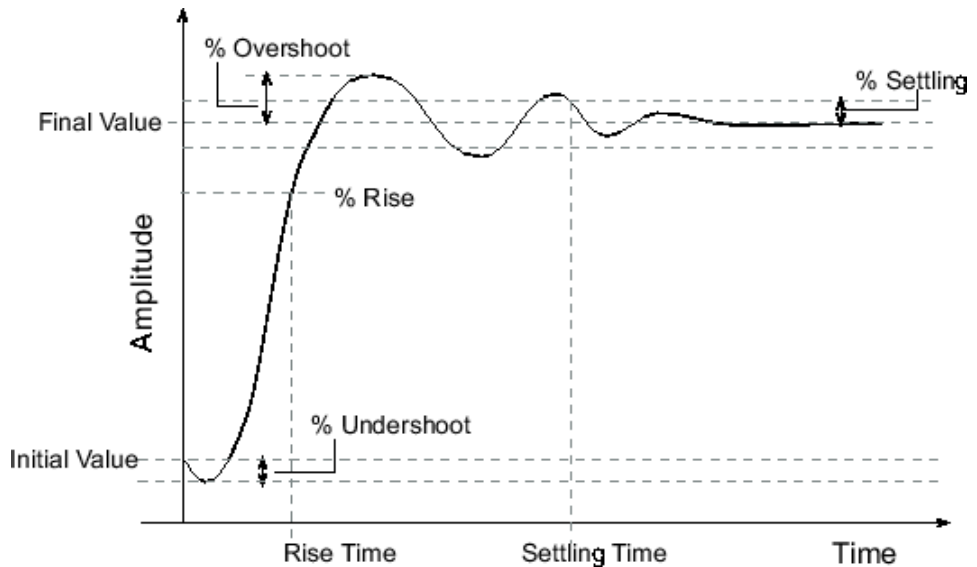

- **Rise time:** The time taken for the response signal to reach a specified percentage of the step's range. The step's range is the difference between the final and initial values.
- **% Rise:** The percentage used in the rise time.
- **Settling time:** The time taken until the response signal settles within a specified region around the final value. This settling region is defined as the final step value plus or minus the specified percentage of the final value.
- **% Settling:** The percentage used in the settling time.
- **% Overshoot:** The amount by which the response signal can exceed the final value. This amount is specified as a percentage of the step's range. The step's range is the difference between the final and initial values.
- **% Undershoot:** The amount by which the response signal can undershoot the initial value. This amount is specified as a percentage of the step's range. The step's range is the difference between the final and initial values.

Enter values for the response specifications in the **Design Requirements** editor, based on the requirements of your model, and then click **OK**. The constraint edges will now reflect the constraints specified.

Importing, Exporting, and Deleting Models in the LTI Viewer

In this section...

“Importing Models” on page 12-12

“Exporting Models” on page 12-13

“Deleting Models” on page 12-14

Importing Models

To import models into the LTI Viewer, select **Import** under the **Edit** menu. This opens the **LTI Browser**, shown below.

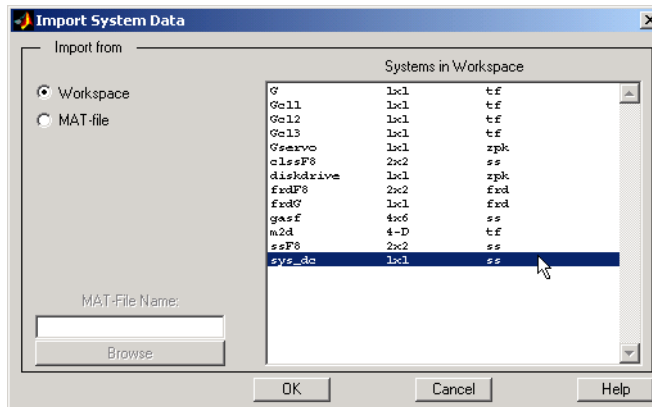

Use the **LTI Browser** to import LTI models into or from the LTI Viewer workspace.

To import a model:

- Click on the desired model in the LTI Browser List. To perform multiple selections:
 - Hold the Control key and click on nonadjacent models.
 - Hold the Shift key while clicking to select multiple adjacent models.

- Click the **OK** or **Apply** Button

Note that the **LTI Browser** lists only the LTI models in the MATLAB workspace.

Alternatively, you can directly import a model into the LTI Viewer using the `ltiview` function, as in

```
ltiview({'step', 'bode'}, modelname)
```

See the `ltiview` function for more information.

Exporting Models

Use **Export** in the **File** menu to open the **LTI Viewer Export** window, shown below.

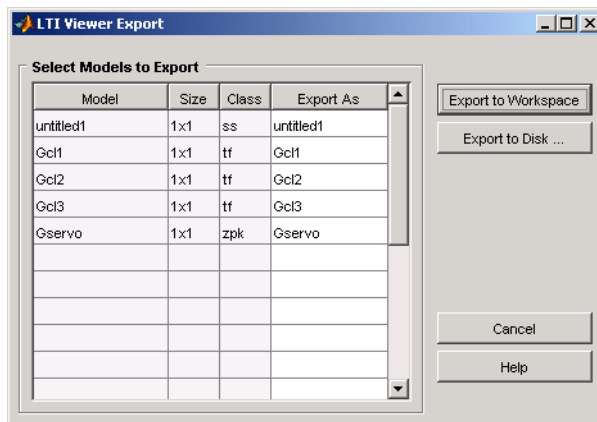

The **LTI Viewer Export** window lists all the models with responses currently displayed in your LTI Viewer. You can export models back to the MATLAB workspace or to disk.

To export single or multiple models, follow the steps described in the importing models section above. If you choose **Export to Disk**, this window opens.

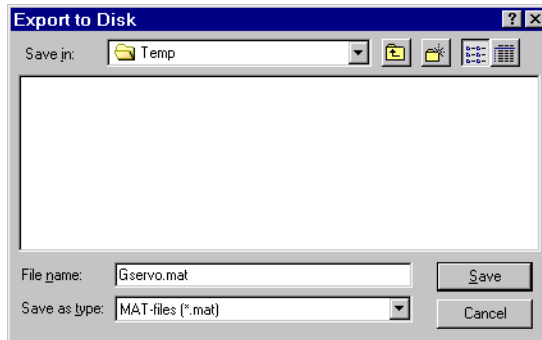

Choose a name for your model(s) and click **Save**. Your models are stored in a MAT-file.

Deleting Models

Select **Edit->Delete** to open the **LTI Viewer Delete** window.

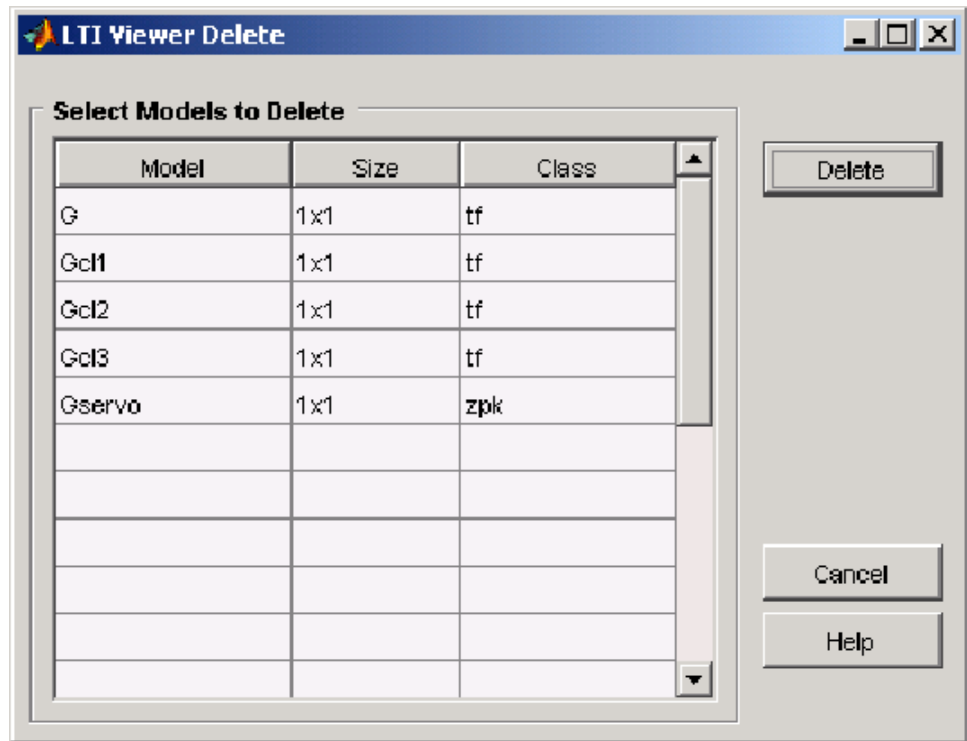

To delete a model:

- Click on the desired model in the Model list. To perform multiple selections:
 - 1 Click and drag over several variables in the list.
 - 2 Hold the Control key and click on individual variables.
 - 3 Hold the Shift key while clicking, to select a range.

Click the **Delete** button.

Selecting Response Types

In this section...

“Methods for Selecting Response Types” on page 12-16

“Right Click Menu: Plot Type” on page 12-16

“Plot Configurations Window” on page 12-16

“Line Styles Editor” on page 12-18

Methods for Selecting Response Types

There are two methods for selecting response plots in the LTI Viewer:

- Selecting **Plot Type** from the right-click menus
- Opening the **Plot Configurations** window

Right Click Menu: Plot Type

If you have a plot open in the LTI Viewer, you can switch to any other response plot available by selecting **Plot Type** from the right click menu.

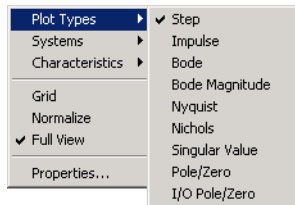

To change the response plot, select the new plot type from the **Plot Type** submenu. The LTI Viewer automatically displays the new response plot.

Plot Configurations Window

The Plot Type feature of the right-click menu works on existing plots, but you can also add plots to an LTI Viewer by using the **Plot Configurations** window. By default, the LTI Viewer opens with a closed-loop step response. To reconfigure an open viewer, select **Plot Configuration** in the **Edit** menu.

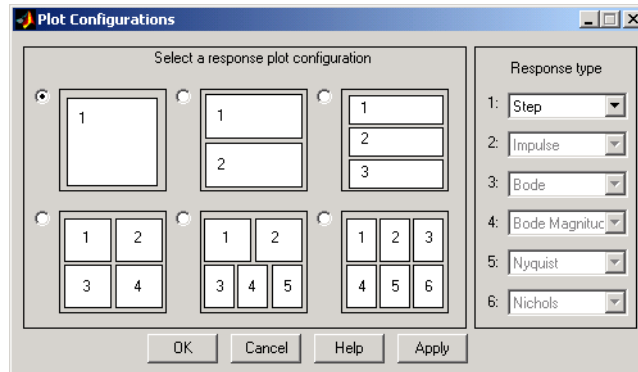

Use the radio buttons to select the number of plots you want displayed in your LTI Viewer. For each plot, select a response type from the menus located on the right-hand side of the window.

It's possible to configure a single LTI Viewer to contain up to six response plots.

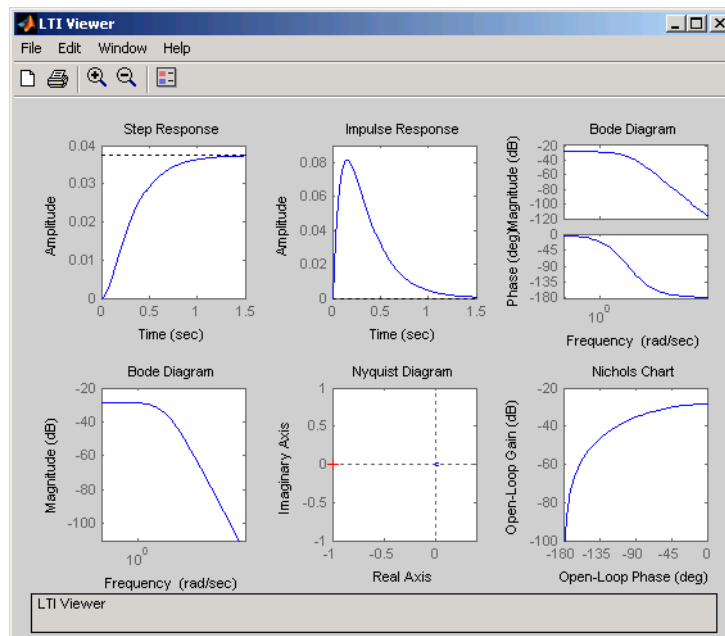

Available response plots include: step, impulse, Bode (magnitude and phase, or magnitude only), Nyquist, Nichols, sigma, pole/zero maps, and I/O pole/zero maps.

Line Styles Editor

Select **Edit-> Line Styles** to open the **Line Styles** editor.

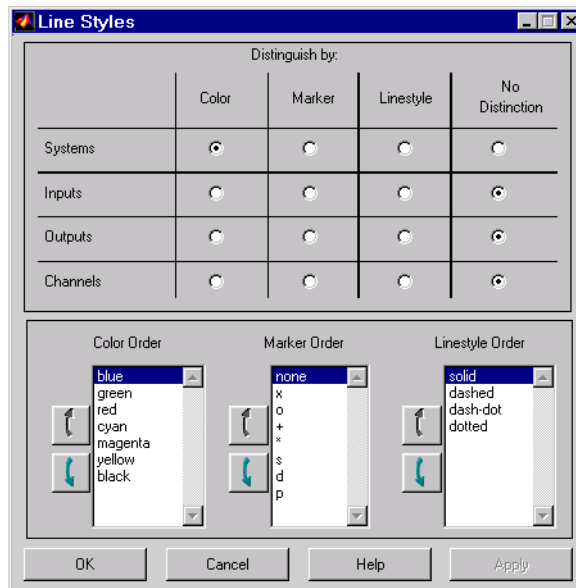

The **Line Styles** editor is particularly useful when you have multiple systems imported. You can use it change line colors, add and rearrange markers, and alter line styles (solid, dashed, and so on).

You can use the **Linestyle Preferences** window to customize the appearance of the response plots by specifying:

- The line property used to distinguish different systems, inputs, or outputs
- The order in which these line properties are applied

Each LTI Viewer has its own **Linestyle Preferences** window.

Setting Preferences

You can use the "Distinguish by" matrix (the top half of the window) to specify the line property that will vary throughout the response plots. You can group multiple plot curves by systems, inputs, outputs, or channels (individual input/output relationships). Note that the Line Styles editor uses radio buttons, which means that you can only assign one property setting for each grouping (system, input, etc.).

Ordering Properties

The **Order** field allows you to change the default property order used when applying the different line properties. You can reorder the colors, markers, and linestyles (e.g., solid or dashed).

To change any of the property orders, click the up or down arrow button to the left of the associated property list to move the selected property up or down in the list.

Analyzing MIMO Models

In this section...
“Overview of Analyzing MIMO Models” on page 12-20
“Array Selector” on page 12-21
“I/O Grouping for MIMO Models” on page 12-23
“Selecting I/O Pairs” on page 12-24

Overview of Analyzing MIMO Models

If you import a MIMO system, or an LTI array containing multiple linear models, you can use special features of the right-click menu to group the response plots by input/output (I/O) pairs or select individual plots for display. For example, if you randomly generate a 3-input, 3-output MIMO system,

```
sys_mimo=rss(3,3,3);
```

and open an LTI Viewer,

```
ltiview(sys_mimo);
```

the default is an unwrapped set of 9 plots, one from each input to each output.

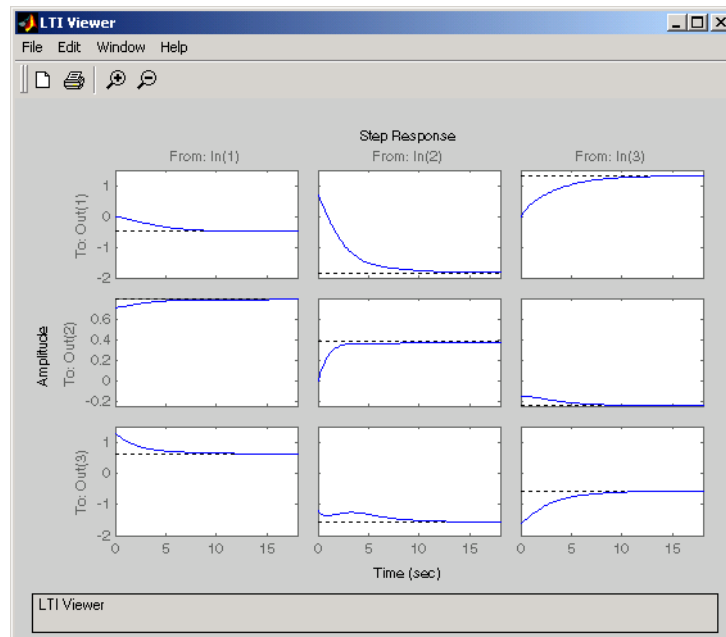

Array Selector

If you import an LTI array into your LTI Viewer, **Array Selector** appears as an option in the right-click menu. Selecting this option opens the **Model Selector for LTI Arrays**, shown below.

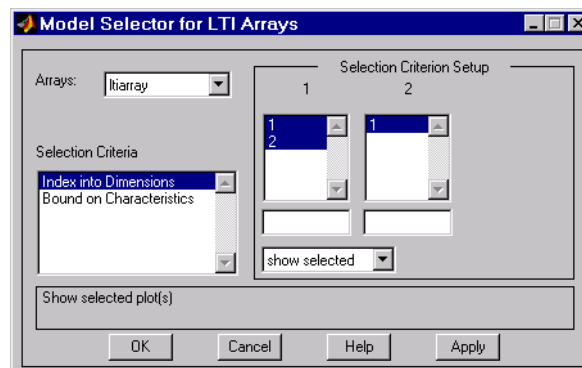

You can use this window to include or exclude models within the LTI array using various criteria. The following subsections discuss the features in turn.

Arrays

Select which LTI array for applying model selection options by using the Arrays pull-down list.

Selection Criteria

There are two selection criteria. The default, **Index into Dimensions**, allows you to include or exclude specified indices of the LTI Array. Select systems from the **Selection Criteria Setup** and specify whether to show or hide the systems using the pull-down menu below the Setup lists.

The second criterion is **Bound on Characteristics**. Selecting this options causes the Model Selector to reconfigure. The reconfigured window is shown below.

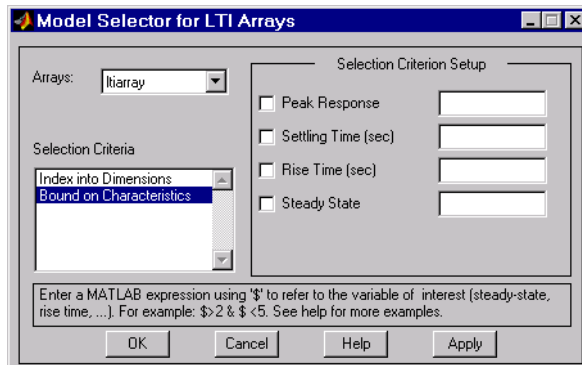

Use this option to select systems for inclusion or exclusion in your LTI Viewer based on their time response characteristics. The panel directly above the buttons describes how to set the inclusion or exclusion criteria based on which selection criteria you select from the reconfigured **Selection Criteria Setup** panel.

I/O Grouping for MIMO Models

You can group this by inputs, by outputs, or both by selecting **I/O Grouping** and then **Inputs**, **Outputs**, or **All**, respectively, from the right-click menu.

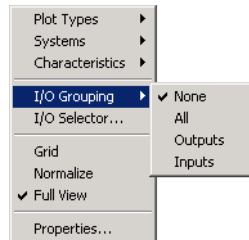

For example, if you select **Outputs**, the LTI Viewer reconfigures into 3 plots, one for each input.

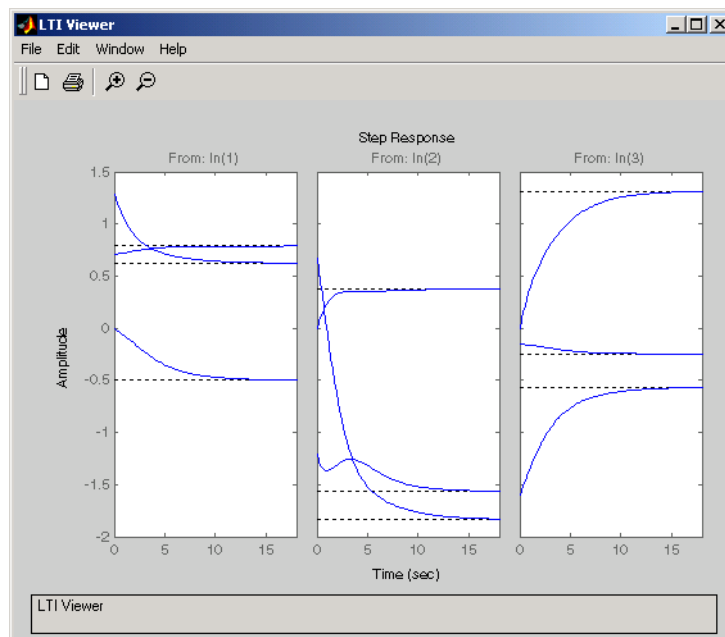

Selecting **None** returns to the default configuration, where all I/O pairs are displayed individually.

Selecting I/O Pairs

Another way to organize MIMO system information is to choose **I/O Selector** from the right-click menu, which opens the **I/O Selector** window.

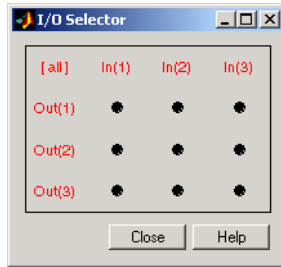

This window automatically configures to the number of I/O pairs in your MIMO system. You can select:

- Any individual plot (only one at a time) by clicking on a button
- Any row or column by clicking on Y^* or U^*
- All of the plots by clicking [all]

Using these options, you can inspect individual I/O pairs, or look at particular I/O channels in detail.

Customizing the LTI Viewer

In this section...

“Overview of Customizing the LTI Viewer” on page 12-25

“LTI Viewer Preferences Editor” on page 12-25

Overview of Customizing the LTI Viewer

The LTI Viewer has a tool preferences editor, which allows you to set default characteristics for specific instances of LTI Viewers. If you open a new instance of either, each defaults to the characteristics specified in the **Toolbox Preferences** editor.

LTI Viewer Preferences Editor

Select **Viewer Preferences** in the **Edit** menu of the LTI Viewer to open the **LTI Viewer Preferences** editor. This figure shows the editor open to its first pane.

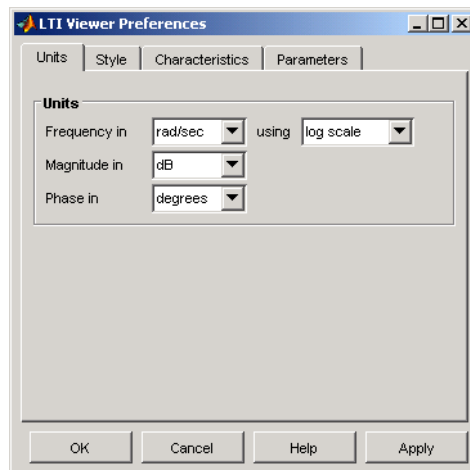

The **LTI Viewer Preferences** editor contains four panes:

- **Units**—Convert between various units, including rad/sec and Hertz

- Style—Customize grids, fonts, and colors
- Characteristics—Specify response plot characteristics, such as settling time tolerance
- Parameters—Set time and frequency ranges, stop times, and time step size

If you want to customize the settings for all instances of LTI Viewers, see the Toolbox Preferences editor.

A

addition of LTI models 2-12
 scalar 2-13
 adjoint.. *See* pertransposition
 append 2-17 to 2-18 4-31
 array dimensions 4-8
 array selector for LTI Viewer 12-21
 arrays. *See* LTI arrays 4-2

B

building LTI arrays 4-13

C

cell array 1-15 1-18
 classical control 9-2 9-19
 closed loop.. *See* feedback
 concatenation, model 1-14
 horizontal 2-18
 LTI arrays 4-16
 state-space model order, effects on 2-10
 vertical 2-18
 connection
 feedback 9-11
 parallel 2-13 9-53
 series 2-14 9-14
 constructor functions, LTI objects 1-7
 continuous-time 3-2
 conversion, model
 automatic 1-47
 between model types 1-46 2-3
 continuous to discrete (c2d) 2-21
 discrete to continuous (d2c) 1-42 2-21

 with negative real poles 2-22
 FRD model, to 1-46
 resampling 2-31
 SS model, to 1-46
 state-space, to 1-48
 TF model, to 1-46
 ZPK model, to 1-46
 covariance
 error 9-56 9-60
 customizing plots 8-2
 customizing subplots 8-11

D

d2d 2-31
 delays
 discrete-time models 1-71
 discretization 2-28
 I/O 1-33 to 1-34
 input 1-31 1-50
 output 1-32 1-50
 Pade approximation 1-65
 deletion
 parts of LTI arrays 4-26
 parts of LTI models 2-10
 denominator
 property 1-33
 specification 1-12 1-15 1-27
 value 1-29
 descriptor systems.. *See* state-space models,
 descriptor
 design
 classical 9-2 9-19
 Kalman estimator 9-35 9-49 9-57
 LQG 9-30
 regulators 9-30
 robustness 9-27
 root locus 9-8 9-23
 desired responses
 step responses 12-9

- digital filter
 - `filt` 1-27
 - specification 1-27
 - dimensions
 - array 4-8
 - I/O 4-8
 - discrete-time models 1-24 3-2
 - control design 9-19
 - Kalman estimator 9-50
 - resampling 2-31
 - upsampling 2-31
 - See also* LTI models
 - discretization 1-42 2-21 9-20
 - delay systems 2-28
 - first-order hold 2-23
 - matched poles/zeros 2-28
 - Tustin method 2-27
 - zero-order hold 2-21
 - dual.. *See* transposition
- E**
- error covariance 9-56 9-60
 - extraction
 - LTI arrays, in 4-24
 - LTI models, in 2-5
- F**
- feedback 9-11
 - feedthrough gain 1-34
 - `filt` 1-27
 - filtering.. *See* Kalman estimator
 - first-order hold (FOH) 2-23
 - with delays 2-28
 - FRD (frequency response data) objects 1-7 1-22
 - conversion to 1-46
 - frequencies
 - indexing by 2-8
 - referencing by 2-8
 - uses 1-7
 - frequency response 1-22
- G**
- gain 1-16
 - feedthrough 1-34
 - property
 - LTI properties gain 1-34
 - gain margins 9-27
 - `get` 1-37
 - Graphical design window 11-2
 - Graphical Tuning Preferences Editor 7-8
 - group. *See* I/O groups 2-9
- I**
- I/O
 - concatenation 2-17
 - delays 1-33 to 1-34
 - dimensions 3-2
 - LTI arrays 4-8
 - groups 1-32
 - referencing models by group name 2-9
 - names 1-32 1-43
 - conflicts, naming 2-4
 - referencing models by 2-9
 - relation 2-5
 - indexing into LTI arrays 4-22
 - single index access 4-23
 - inheritance 2-3
 - input 1-3
 - delays 1-31 1-50
 - groups 1-32
 - names 1-32
 - number of inputs 3-2
 - `InputDelay`. . *See* delays
 - `InputGroup` 1-32 2-4
 - conflicts, naming 2-4

See also I/O groups
 InputName 1-40 1-42 2-4
 conflicts, naming 2-4
See also I/O names
 inversion
 model 2-15
 ioDelayMatrix. . *See* delay

K

Kalman
 filtering 9-49
 Kalman estimator
 continuous 9-35
 discrete 9-50
 time-varying 9-57

L

LQG (linear quadratic-gaussian) method
 continuous LQ regulator 9-35
 cost function 9-35
 design 9-30 9-45
 LQ-optimal gain 9-35
 regulator 9-30
 LTI (linear time-invariant) 1-2

LTI arrays 4-2
 accessing models 4-23
 analysis functions 4-32
 array dimensions 4-8
 building 4-16
 building LTI arrays 4-13
 building with `rss` 4-21
 building with `tf`, `zpk`, `ss`, and `frd` 4-18
 concatenation 4-16
 conversion, model.. *See* conversion
 deleting parts of 4-26
 dimensions, size, and shape 4-8
 extracting subsystems 4-24
 indexing into 4-22 to 4-23
 interconnection functions 4-27
 model dimensions 4-8
 operations on 4-27
 dimension requirements 4-29
 special cases 4-30
 reassigning parts of 4-25
 size 4-8
 stack 4-16
 LTI models
 addition 2-12
 scalar 2-13
 building 2-17
 characteristics 3-2
 concatenation
 effects on model order 2-10
 horizontal 2-18
 vertical 2-18
 continuous 3-2
 conversion 1-46 2-3 2-22
 continuous/discrete 2-21

- See also* conversion, model
 - creating 1-12
 - discrete 1-24 3-2
 - discretization, matched poles/zeros 2-28
 - empty 1-16 3-2
 - functions, analysis 3-4
 - I/O group or channel name, referencing
 - by 2-9
 - interconnection functions 2-17
 - inversion 2-15
 - model data, accessing 1-28
 - modifying 2-5
 - multiplication 2-14
 - operations 1-9 2-1
 - precedence rules 2-3
 - See also* operations
 - proper transfer function 3-2
 - resizing 2-10
 - subsystem, modifying 2-10
 - subtraction 2-13
 - type 3-2
 - LTI objects 1-31 1-38
 - constructing 1-7
 - methods 1-8
 - properties.. *See* LTI properties
 - See also* LTI models
 - LTI properties 1-8 1-31 1-40
 - accessing property values (`get`) 1-37 to 1-38
 - displaying properties 1-38
 - generic properties 1-31
 - I/O groups.. *See* I/O, groups
 - I/O names.. *See* I/O, names
 - inheritance 2-3
 - model-specific properties 1-33
 - online help (`ltiprops`) 1-31
 - property names 1-31 1-36
 - property values 1-31 1-37
 - setting 1-35
 - sample time 2-3
 - variable property 2-4
 - LTI Viewer
 - array selector 12-21
 - configuring plots 12-16
 - customization 12-25
 - I/O grouping 12-23
 - importing/exporting models 12-12
 - MIMO models 12-20
 - overview 12-2
 - right-click menu 12-4
 - selecting I/O pairs 12-24
 - selecting response types 12-16
 - SISO Design Task 11-2
 - LTI Viewer Preferences Editor 7-3
- M**
- map, I/O 2-5
 - margins, gain and phase 9-27
 - methods 1-8
 - MIMO 1-2 2-18
 - model building 2-17
 - feedback connection 9-11
 - parallel connection 2-13 9-53
 - series connection 2-14 9-14
 - model dynamics, function list 3-4
 - modeling.. *See* model building
 - multiplication 2-14
 - scalar 2-15
- N**
- Notes 1-33
 - numerator
 - property 1-33
 - specification 1-12 1-15 1-27
 - value 1-29
- O**
- object-oriented programming 1-8
 - objects.. *See* LTI objects

operations on LTI models
 addition 2-12
 append 2-18
 arithmetic 2-12
 concatenation 1-14 2-10 2-18
 extracting a subsystem 1-9
 inversion 2-15
 multiplication 2-14
 overloaded 1-8
 pertransposition 2-16
 precedence 2-3
 resizing 2-10
 subsystem, extraction 2-5
 subtraction 2-13
 transposition 2-15

output 1-3
 delays 1-32 1-50
 groups 1-32
 names 1-32
 number of outputs 3-2

OutputDelay. . *See* delays

OutputGroup 1-32
 group names, conflicts 2-4
See also I/O, groups 2-4

OutputName 1-40
 conflicts, naming 2-4
See also I/O, names 1-40

P

Pade approximation (pade) 1-65
 parallel connection 2-13 9-53
 pertransposition 2-16
 phase margins 9-27
 plot customization 8-2
 Plot Tools 8-12
 poles 1-16
 property 1-34
 precedence rules 1-8 2-3
 proper transfer function 3-2

properties
 sample time 2-3
 variable 2-4

properties.. *See* LTI properties

Property Editor 8-3

R

realizations 3-7
 regulation 9-30
 resampling 2-31
 response, I/O 2-5
 robustness 9-27
 root locus 9-23
 design 9-8 9-23
See also Root Locus Design GUI

rss
 building an LTI array with 4-21

S

sample time 1-24 1-32 1-40 2-3
 accessing 1-28
 resampling 2-31
 setting 1-42
 unspecified 1-32
 upsampling 2-31

scaling 10-2

series connection 2-14 9-14

set 1-35

SISO 1-2 3-2

SISO Design Task in the Control and Estimation
 Tools Manager 11-2

SISO Design Tool 11-2
 customizing plots 8-37
 root locus right-click menu 11-54

ss 1-19

SS models 2-16

SS objects.. *See* state-space models

stack 4-16

- state 1-19
 - matrix 1-34
 - names 1-34
 - vector 1-3
 - state-space models 1-3 1-7
 - conversion to 1-46
 - See also* conversion 1-46
 - descriptor 1-21 1-28
 - matrices 1-19
 - model data 1-19
 - quick data retrieval 1-28
 - realizations 3-7
 - scaling 10-2
 - specification 1-19
 - ss 1-19
 - transfer functions of 1-47
 - step responses
 - specifications 12-9
 - subplot customization 8-11
 - subsystem 1-9 2-5
 - subsystem operations on LTI models
 - subsystem, modifying 2-10
 - subtraction 2-13
- T**
- Td. . *See* delays
 - tf 1-12
 - TF objects.. *See* transfer functions
 - tfdata
 - output, form of 1-28
 - time delays.. *See* delays
 - time-varying Kalman filter 9-57
 - Toolbox Preferences Editor 6-2
- transfer functions 1-2 1-7
 - constructing with rational expressions 1-13
 - conversion to 1-46
 - denominator 1-12
 - discrete-time 1-24 1-27
 - DSP convention 1-27
 - filt 1-27
 - MIMO 1-14 2-18
 - numerator 1-12
 - quick data retrieval 1-28
 - specification 1-12
 - static gain 1-16
 - tf 1-12
 - TF object, display for 1-13
 - variable property 1-33 2-4
 - transposition 2-15
 - triangle approximation 2-23
 - Ts. *See* sample time 1-40
 - Tustin approximation 2-27
 - with frequency prewarping 2-28
- U**
- Userdata 1-33
- V**
- variable property 2-4
- Z**
- zero-order hold (ZOH) 2-21 9-20
 - with delays 2-28
 - zero-pole-gain (ZPK) models 1-2 1-7
 - conversion to 1-46
 - MIMO 1-18 2-18
 - quick data retrieval 1-28
 - specification 1-16
 - zpk 1-17
 - zeros 1-16
 - property 1-33

zpk 1-17

ZPK objects.. *See* zero-pole-gain (ZPK) models

zpkdata

output, form of 1-28